

HITACHI IC MEMORY DATA BOOK

HITACHI IC MEMORY DATA BOOK

INDEX

■ QUICK REFERENCE GUIDE TO HITACHI IC MEMORIES	8
● MOS RAM	8
● MOS ROM	10
● MOS Memories of Wide Operating Temperature Range	10
● Bipolar RAM	11
● Bipolar PROM	12
■ PACKAGE INFORMATION	13
■ RELIABILITY OF HITACHI IC MEMORIES	18
■ PRECAUTIONS FOR HANDLING IC MEMORIES	26
■ QUALITY ASSURANCE OF IC MEMORIES	29
■ OUTLINE OF TESTING METHOD	35
■ APPLICATION OF DYNAMIC RAMS	38
■ PROGRAMMING & ERASING OF PROMS	40
● Programming & Erasing of EPROM	40
● Programming of Bipolar PROM	44
■ MASK ROM PROGRAMMING INSTRUCTION	47
■ DATA SHEETS	51
● MOS STATIC RAM	51
HM4334-3 1024-word x 4-bit RAM (CMOS)	52
HM4334-4 1024-word x 4-bit RAM (CMOS)	52
HM4334P-3 1024-word x 4-bit RAM (CMOS)	52
HM4334P-4 1024-word x 4-bit RAM (CMOS)	52
HM4334P-3L 1024-word x 4-bit RAM (CMOS)	57
HM4334P-4L 1024-word x 4-bit RAM (CMOS)	57
HM6148 1024-word x 4-bit RAM (CMOS)	62
HM6148-6 1024-word x 4-bit RAM (CMOS)	62
HM6148P 1024-word x 4-bit RAM (CMOS)	62
HM6148P-6 1024-word x 4-bit RAM (CMOS)	62
HM6148LP 1024-word x 4-bit RAM (CMOS)	68
HM6148LP-6 1024-word x 4-bit RAM (CMOS)	68
HM6148H-35 1024-word x 4-bit RAM (CMOS)	74
HM6148H-45 1024-word x 4-bit RAM (CMOS)	74
HM6148H-55 1024-word x 4-bit RAM (CMOS)	74
HM6148HP-35 1024-word x 4-bit RAM (CMOS)	74
HM6148HP-45 1024-word x 4-bit RAM (CMOS)	74
HM6148HP-55 1024-word x 4-bit RAM (CMOS)	74
HM6148HLP-35 1024-word x 4-bit RAM (CMOS)	78
HM6148HLP-45 1024-word x 4-bit RAM (CMOS)	78
HM6148HLP-55 1024-word x 4-bit RAM (CMOS)	78
HM6147 4096-word x 1-bit RAM (CMOS)	83
HM6147-3 4096-word x 1-bit RAM (CMOS)	83
HM6147P 4096-word x 1-bit RAM (CMOS)	83
HM6147P-3 4096-word x 1-bit RAM (CMOS)	83
HM6147LP 4096-word x 1-bit RAM (CMOS)	87
HM6147LP-3 4096-word x 1-bit RAM (CMOS)	87
HM6147H-35 4096-word x 1-bit RAM (CMOS)	91
HM6147H-45 4096-word x 1-bit RAM (CMOS)	91
HM6147H-55 4096-word x 1-bit RAM (CMOS)	91
HM6147HP-35 4096-word x 1-bit RAM (CMOS)	91
HM6147HP-45 4096-word x 1-bit RAM (CMOS)	91
HM6147HP-55 4096-word x 1-bit RAM (CMOS)	91

HM6147HLP-35	4096-word x 1-bit RAM (CMOS)	97
HM6147HLP-45	4096-word x 1-bit RAM (CMOS)	97
HM6147HLP-55	4096-word x 1-bit RAM (CMOS)	97
HM6116-2	2048-word x 8-bit RAM (CMOS)	101
HM6116-3	2048-word x 8-bit RAM (CMOS)	101
HM6116-4	2048-word x 8-bit RAM (CMOS)	101
HM6116I-2	2048-word x 8-bit RAM (CMOS)	107
HM6116I-3	2048-word x 8-bit RAM (CMOS)	107
HM6116I-4	2048-word x 8-bit RAM (CMOS)	107
HM6116P-2	2048-word x 8-bit RAM (CMOS)	101
HM6116P-3	2048-word x 8-bit RAM (CMOS)	101
HM6116P-4	2048-word x 8-bit RAM (CMOS)	101
HM6116PI-2	2048-word x 8-bit RAM (CMOS)	111
HM6116PI-3	2048-word x 8-bit RAM (CMOS)	111
HM6116PI-4	2048-word x 8-bit RAM (CMOS)	111
HM6116FP-2	2048-word x 8-bit RAM (CMOS)	115
HM6116FP-3	2048-word x 8-bit RAM (CMOS)	115
HM6116FP-4	2048-word x 8-bit RAM (CMOS)	115
HM6116CG-2	2048-word x 8-bit RAM (CMOS)	120
HM6116CG-3	2048-word x 8-bit RAM (CMOS)	120
HM6116CG-4	2048-word x 8-bit RAM (CMOS)	120
HM6116L-2	2048-word x 8-bit RAM (CMOS)	124
HM6116L-3	2048-word x 8-bit RAM (CMOS)	124
HM6116L-4	2048-word x 8-bit RAM (CMOS)	124
HM6116LI-2	2048-word x 8-bit RAM (CMOS)	131
HM6116LI-3	2048-word x 8-bit RAM (CMOS)	131
HM6116LI-4	2048-word x 8-bit RAM (CMOS)	131
HM6116LP-2	2048-word x 8-bit RAM (CMOS)	135
HM6116LP-3	2048-word x 8-bit RAM (CMOS)	135
HM6116LP-4	2048-word x 8-bit RAM (CMOS)	135
HM6116LPI-2	2048-word x 8-bit RAM (CMOS)	142
HM6116LPI-3	2048-word x 8-bit RAM (CMOS)	142
HM6116LPI-4	2048-word x 8-bit RAM (CMOS)	142
HM6116LFP-2	2048-word x 8-bit RAM (CMOS)	146
HM6116LFP-3	2048-word x 8-bit RAM (CMOS)	146
HM6116LFP-4	2048-word x 8-bit RAM (CMOS)	146
HM6116K-3	2048-word x 8-bit RAM (CMOS)	150
HM6116K-4	2048-word x 8-bit RAM (CMOS)	150
HM6116AP-10	2048-word x 8-bit RAM (CMOS)	154
HM6116AP-12	2048-word x 8-bit RAM (CMOS)	154
HM6116AP-15	2048-word x 8-bit RAM (CMOS)	154
HM6116AP-20	2048-word x 8-bit RAM (CMOS)	154
HM6116ASP-10	2048-word x 8-bit RAM (CMOS)	154
HM6116ASP-12	2048-word x 8-bit RAM (CMOS)	154
HM6116ASP-15	2048-word x 8-bit RAM (CMOS)	154
HM6116ASP-20	2048-word x 8-bit RAM (CMOS)	154
HM6116ALP-10	2048-word x 8-bit RAM (CMOS)	158
HM6116ALP-12	2048-word x 8-bit RAM (CMOS)	158
HM6116ALP-15	2048-word x 8-bit RAM (CMOS)	158
HM6116ALP-20	2048-word x 8-bit RAM (CMOS)	158
HM6116ALSP-10	2048-word x 8-bit RAM (CMOS)	158
HM6116ALSP-12	2048-word x 8-bit RAM (CMOS)	158
HM6116ALSP-15	2048-word x 8-bit RAM (CMOS)	158
HM6116ALSP-20	2048-word x 8-bit RAM (CMOS)	158

HM6117P-3	2048-word x 8-bit RAM (CMOS)	162
HM6117P-4	2048-word x 8-bit RAM (CMOS)	162
HM6117FP-3	2048-word x 8-bit RAM (CMOS)	167
HM6117FP-4	2048-word x 8-bit RAM (CMOS)	167
HM6117LP-3	2048-word x 8-bit RAM (CMOS)	172
HM6117LP-4	2048-word x 8-bit RAM (CMOS)	172
HM6117LFP-3	2048-word x 8-bit RAM (CMOS)	178
HM6117LFP-4	2048-word x 8-bit RAM (CMOS)	178
HM6168H-45	4096-word x 4-bit RAM (CMOS)	184
HM6168H-55	4096-word x 4-bit RAM (CMOS)	184
HM6168H-70	4096-word x 4-bit RAM (CMOS)	184
HM6168HP-45	4096-word x 4-bit RAM (CMOS)	184
HM6168HP-55	4096-word x 4-bit RAM (CMOS)	184
HM6168HP-70	4096-word x 4-bit RAM (CMOS)	184
HM6168HLP-45	4096-word x 4-bit RAM (CMOS)	185
HM6168HLP-55	4096-word x 4-bit RAM (CMOS)	185
HM6168HLP-70	4096-word x 4-bit RAM (CMOS)	185
HM6167	16384-word x 1-bit RAM (CMOS)	186
HM6167-6	16384-word x 1-bit RAM (CMOS)	186
HM6167-8	16384-word x 1-bit RAM (CMOS)	186
HM6167P	16384-word x 1-bit RAM (CMOS)	186
HM6167P-6	16384-word x 1-bit RAM (CMOS)	186
HM6167P-8	16384-word x 1-bit RAM (CMOS)	186
HM6167LP	16384-word x 1-bit RAM (CMOS)	192
HM6167LP-6	16384-word x 1-bit RAM (CMOS)	192
HM6167LP-8	16384-word x 1-bit RAM (CMOS)	192
HM6167H-45	16384-word x 1-bit RAM (CMOS)	196
HM6167H-55	16384-word x 1-bit RAM (CMOS)	196
HM6167HP-45	16384-word x 1-bit RAM (CMOS)	196
HM6167HP-55	16384-word x 1-bit RAM (CMOS)	196
HM6167HCG-45	16384-word x 1-bit RAM (CMOS)	203
HM6167HCG-55	16384-word x 1-bit RAM (CMOS)	203
HM6167HLP-45	16384-word x 1-bit RAM (CMOS)	207
HM6167HLP-55	16384-word x 1-bit RAM (CMOS)	207
HM6264P-10	8192-word x 8-bit RAM (CMOS)	211
HM6264P-12	8192-word x 8-bit RAM (CMOS)	211
HM6264P-15	8192-word x 8-bit RAM (CMOS)	211
HM6264LP-10	8192-word x 8-bit RAM (CMOS)	215
HM6264LP-12	8192-word x 8-bit RAM (CMOS)	215
HM6264LP-15	8192-word x 8-bit RAM (CMOS)	215
● MOS DYNAMIC RAM		221
HM4716A-1	16384-word x 1-bit RAM (NMOS)	222
HM4716A-2	16384-word x 1-bit RAM (NMOS)	222
HM4716A-3	16384-word x 1-bit RAM (NMOS)	222
HM4716A-4	16384-word x 1-bit RAM (NMOS)	222
HM4716AP-1	16384-word x 1-bit RAM (NMOS)	222
HM4716AP-2	16384-word x 1-bit RAM (NMOS)	222
HM4716AP-3	16384-word x 1-bit RAM (NMOS)	222
HM4716AP-4	16384-word x 1-bit RAM (NMOS)	222
HM4816A-3	16384-word x 1-bit RAM (NMOS)	233
HM4816A-3E	16384-word x 1-bit RAM (NMOS)	233
HM4816A-4	16384-word x 1-bit RAM (NMOS)	233
HM4816A-7	16384-word x 1-bit RAM (NMOS)	233
HM4816AP-3	16384-word x 1-bit RAM (NMOS)	233

HM4816AP-3E	16384-word x 1-bit RAM (NMOS)	233
HM4816AP-4	16384-word x 1-bit RAM (NMOS)	233
HM4816AP-7	16384-word x 1-bit RAM (NMOS)	233
HM4864-2	65536-word x 1-bit RAM (NMOS)	241
HM4864-3	65536-word x 1-bit RAM (NMOS)	241
HM4864P-2	65536-word x 1-bit RAM (NMOS)	241
HM4864P-3	65536-word x 1-bit RAM (NMOS)	241
HM4864CC-2	65536-word x 1-bit RAM (NMOS)	251
HM4864CC-3	65536-word x 1-bit RAM (NMOS)	251
HM4864I-2	65536-word x 1-bit RAM (NMOS)	256
HM4864I-3	65536-word x 1-bit RAM (NMOS)	256
HM4864K-2	65536-word x 1-bit RAM (NMOS)	256
HM4864K-3	65536-word x 1-bit RAM (NMOS)	256
HM4864A-12	65536-word x 1-bit RAM (NMOS)	260
HM4864A-15	65536-word x 1-bit RAM (NMOS)	260
HM4864A-20	65536-word x 1-bit RAM (NMOS)	260
HM4864AP-12	65536-word x 1-bit RAM (NMOS)	260
HM4864AP-15	65536-word x 1-bit RAM (NMOS)	260
HM4864AP-20	65536-word x 1-bit RAM (NMOS)	260
HM4864ACG-12	65536-word x 1-bit RAM (NMOS)	265
HM4864ACG-15	65536-word x 1-bit RAM (NMOS)	265
HM4864ACG-20	65536-word x 1-bit RAM (NMOS)	265
HM4865AP-12	65536-word x 1-bit RAM (NMOS)	270
HM4865AP-15	65536-word x 1-bit RAM (NMOS)	270
HM4865AP-20	65536-word x 1-bit RAM (NMOS)	270
HM50256-12	262144-word x 1-bit RAM (NMOS)	277
HM50256-15	262144-word x 1-bit RAM (NMOS)	277
HM50256-20	262144-word x 1-bit RAM (NMOS)	277
HM50257-12	262144-word x 1-bit RAM (NMOS)	284
HM50257-15	262144-word x 1-bit RAM (NMOS)	284
HM50257-20	262144-word x 1-bit RAM (NMOS)	284
● MOS Mask ROM		291
HN61364P	8192-word x 8-bit ROM (CMOS)	292
HN61364FP	8192-word x 8-bit ROM (CMOS)	292
HN61365P	8192-word x 8-bit ROM (CMOS)	294
HN61366P	8192-word x 8-bit ROM (CMOS)	296
HN43128P	16384-word x 8-bit or 32768-word x 4-bit ROM (CMOS)	298
HN613128P	16384-word x 8-bit ROM (CMOS)	300
HN613128FP	16384-word x 8-bit ROM (CMOS)	300
HN61256P	32768-word x 8-bit or 65536-word x 4-bit ROM (CMOS)	302
HN61256FP	32768-word x 8-bit or 65536-word x 4-bit ROM (CMOS)	302
HN613256P	32768-word x 8-bit ROM (CMOS)	304
HN613256FP	32768-word x 8-bit ROM (CMOS)	304
HN62301P	131072-word x 8-bit ROM (CMOS)	306
● MOS PROM		309
HN462716	2048-word x 8-bit U.V. Erasable & Electrically PROM (NMOS)	310
HN462716G	2048-word x 8-bit U.V. Erasable & Electrically PROM (NMOS)	310
HN462532	4096-word x 8-bit U.V. Erasable & Electrically PROM (NMOS)	314

HN462532G	4096-word x 8-bit U.V. Erasable & Electrically PROM (NMOS)	314
HN462732	4096-word x 8-bit U.V. Erasable & Electrically PROM (NMOS)	318
HN462732G	4096-word x 8-bit U.V. Erasable & Electrically PROM (NMOS)	318
HN462732GI	4096-word x 8-bit U.V. Erasable & Electrically PROM (NMOS)	322
HN482732AG-20	4096-word x 8-bit U.V. Erasable & Electrically PROM (NMOS)	325
HN482732AG-25	4096-word x 8-bit U.V. Erasable & Electrically PROM (NMOS)	325
HN482732AG-30	4096-word x 8-bit U.V. Erasable & Electrically PROM (NMOS)	325
HN482764	8192-word x 8-bit U.V. Erasable & Electrically PROM (NMOS)	328
HN482764-3	8192-word x 8-bit U.V. Erasable & Electrically PROM (NMOS)	328
HN482764-4	8192-word x 8-bit U.V. Erasable & Electrically PROM (NMOS)	328
HN482764G	8192-word x 8-bit U.V. Erasable & Electrically PROM (NMOS)	328
HN482764G-3	8192-word x 8-bit U.V. Erasable & Electrically PROM (NMOS)	328
HN482764G-4	8192-word x 8-bit U.V. Erasable & Electrically PROM (NMOS)	328
HN4827128G-25	16384-word x 8-bit U.V. Erasable & Electrically PROM (NMOS)	332
HN4827128G-30	16384-word x 8-bit U.V. Erasable & Electrically PROM (NMOS)	332
HN4827128G-45	16384-word x 8-bit U.V. Erasable & Electrically PROM (NMOS)	332
HN48016P	2048-word x 8-bit Electrically Erasable & PROM (NMOS)	336
● Bipolar RAM		341
HM10414	256-word x 1-bit RAM (ECL 10K)	342
HM10414-1	256-word x 1-bit RAM (ECL 10K)	342
HM2110	1024-word x 1-bit RAM (ECL 10K)	346
HM2110-1	1024-word x 1-bit RAM (ECL 10K)	346
HM2112	1024-word x 1-bit RAM (ECL 10K)	350
HM2112-1	1024-word x 1-bit RAM (ECL 10K)	350
HM10422	256-word x 4-bit RAM (ECL 10K)	355
HM10422-7	256-word x 4-bit RAM (ECL 10K)	360
HM10470	4096-word x 1-bit RAM (ECL 10K)	363
HM10470-1	4096-word x 1-bit RAM (ECL 10K)	363
HM10470F	4096-word x 1-bit RAM (ECL 10K)	363
HM10470-15	4096-Word x 1-bit RAM (ECL 10K)	368
HM2142	4096-word x 1-bit RAM (ECL 10K)	371
HM10474	1024-word x 4-bit RAM (ECL 10K)	374
HM10474-15	1024-word x 4-bit RAM (ECL 10K)	374
HM10480	16384-word x 1-bit RAM (ECL 10K)	379
HM10480F	16384-word x 1-bit RAM (ECL 10K)	379
HM100415	1024-word x 1-bit RAM (ECL 100K)	382
HM100415CC	1024-word x 1-bit RAM (ECL 100K)	382

HM100422	256-word x 4-bit RAM (ECL 100K)	385
HM100422F	256-word x 4-bit RAM (ECL 100K)	385
HM100422CC	256-word x 4-bit RAM (ECL 100K)	385
HM100470	4096-word x 1-bit RAM (ECL 100K)	388
HM100470-15	4096-word x 1-bit RAM (ECL 100K)	388
HM100474	1024-word x 4-bit RAM (ECL 100K)	391
HM100474-15	1024-word x 4-bit RAM (ECL 100K)	391
HM100474F	1024-word x 4-bit RAM (ECL 100K)	391
HM100474F-15	1024-word x 4-bit RAM (ECL 100K)	391
HM100480	16384-word x 1-bit RAM (ECL 100K)	396
HM100480F	16384-word x 1-bit RAM (ECL 100K)	396
HM2504	256-word x 1-bit RAM (TTL)	399
HM2504-1	256-word x 1-bit RAM (TTL)	399
HM2510	1024-word x 1-bit RAM (TTL)	403
HM2510-1	1024-word x 1-bit RAM (TTL)	403
HM2510-2	1024-word x 1-bit RAM (TTL)	403
HM2511	1024-word x 1-bit RAM (TTL)	407
HM2511-1	1024-word x 1-bit RAM (TTL)	407
● Bipolar PROM		411
HN25044	1024-word x 4-bit PROM (TTL)	414
HN25045	1024-word x 4-bit PROM (TTL)	414
HN25084	2048-word x 4-bit PROM (TTL)	419
HN25085	2048-word x 4-bit PROM (TTL)	419
HN25084S	2048-word x 4-bit PROM (TTL)	422
HN25085S	2048-word x 4-bit PROM (TTL)	422
HN25088	1024-word x 8-bit PROM (TTL)	425
HN25089	1024-word x 8-bit PROM (TTL)	425
HN25088S	1024-word x 8-bit PROM (TTL)	428
HN25089S	1024-word x 8-bit PROM (TTL)	428
HN25088L	1024-word x 8-bit PROM (TTL)	431
HN25089L	1024-word x 8-bit PROM (TTL)	431
HN25168S	2048-word x 8-bit PROM (TTL)	434
HN25169S	2048-word x 8-bit PROM (TTL)	434
● Memory Support Circuits		437
HD2912	Quadruple TTL-to-MOS Clock Drivers	438
HD2916	Quadruple TTL-to-MOS Clock Drivers	441
HD2923	Quadruple ECL-to-TTL Drivers	444

NOTICE

The example of an applied circuit or combination with other equipment shown herein indicates characteristics and performance of a semiconductor-applied products. The company shall assume no responsibility for any problem involving a patent caused when applying the descriptions in the example.

QUICK REFERENCE GUIDE TO HITACHI IC MEMORIES

MOS RAM

Mode	Total Bit	Type No.	Process	Organi- zation (word × bit)	Access Time (ns) max	Cycle Time (ns) min	Supply Voltage (V)	Power Dissi- pation (W)	Package*						Replace- ment	Page		
									Pin No.	CC	CG	G	P	FP			SP	
Static	4k-bit	HM4334-3	CMOS	1024 × 4	300	460	+5	10μ/20m			●	●			HM-6514-9	52		
		HM4334-4			450	640					●	●				52		
		HM4334-3L			300	460		10μ/20m			●					57		
		HM4334-4L			450	640					●					57		
		HM6148			70	70		0.1m/0.2			●	●			2148	62		
		HM6148-6			85	85					●	●			2148-6	62		
		HM6148L			70	70		5μ/0.2				●				68		
		HM6148L-6			85	85						●				68		
		HM6148H-35**			35	35		0.1m/0.2				●	●			74		
		HM6148H-45**			45	45						●	●		2148-45	74		
		HM6148H-55**		55	55	5μ/0.3						●			2148-55	74		
		HM6148HL-35**		35	35							●			78			
		HM6148HL-45**		45	45	0.1m/75m							●			78		
		HM6148HL-55**		55	55								●			78		
		HM6147		70	70	4096 × 1		0.1m/75m					●	●		2147	83	
		HM6147-3		55	55									●	●		83	
		HM6147L		70	70			5μ/75m							●		87	
		HM6147L-3		55	55										●		87	
		HM6147H-35		35	35			0.1m/0.15						●	●		2147H-1	91
		HM6147H-45		45	45									●	●		2147H-2	91
	HM6147H-55	55	55	5μ/0.15								●			91			
	HM6147HL-35	35	35									●			97			
	HM6147HL-45	45	45	0.1m/0.18								●	●		101			
	HM6147HL-55	55	55									●	●		101			
	16k-bit	HM6116-2	120	120	2048 × 8	0.1m/0.18				●	●	●				101		
		HM6116-3	150	150							●	●	●			101		
		HM6116-4	200	200		20μ/0.16					●	●	●			101		
		HM6116L-2	120	120								●	●	●		124		
		HM6116L-3	150	150		0.1m/15m						●	●	●		124		
		HM6116L-4	200	200									●	●	●	124		
		HM6116A-10	100	100		0.1m/15m							●			154		
		HM6116A-12	120	120										●			154	
		HM6116A-15	150	150		5μ/10m								●	●		154	
		HM6116A-20	200	200											●	●	154	
		HM6116AL-10	100	100		0.1m/0.2								●	●		158	
		HM6116AL-12	120	120											●	●	158	
		HM6116AL-15	150	150		10μ/0.18									●	●		158
		HM6116AL-20	200	200												●	●	158
		HM6117-3	150	150		0.1m/0.2									●	●		162
		HM6117-4	200	200												●	●	162
HM6117L-3		150	150	10μ/0.18											●	●		172
HM6117L-4		200	200													●	●	172

(to be continued)

Mode	Total Bit	Type No.	Process	Organization (word × bit)	Access Time (ns) max	Cycle Time (ns) min	Supply Voltage (V)	Power Dissipation (W)	Package***						Replacement	Page			
									Pin No.	CC	CG	G	P	FP			SP		
SRAM	16k-bit	HM6168H-45*	CMOS	4096 × 4	45	45	+5	0.1m/0.25	20			●	●			2168	184		
		HM6168H-55*			55	55						●	●				184		
		HM6168H-70*			70	70						●	●				184		
		HM6168HL-45*			45	45							●				185		
		HM6168HL-55*			55	55							●				185		
		HM6168HL-70*			70	70							●				185		
		HM6167		70	70	16384 × 1								●	●			2167	186
		HM6167-6		85	85							●	●			2167-6	186		
		HM6167-8		100	100							●	●			2167-8	186		
		HM6167L		70	70								●				192		
		HM6167L-6		85	85								●				192		
		HM6167L-8		100	100								●				192		
		HM6167H-45		45	45								●	●	●		IMS1400	196	
		HM6167H-55		55	55								●	●	●			196	
	HM6167HL-45	45	45							●				207					
	HM6167HL-55	55	55							●				207					
	64k-bit	HM6264-10	100	100	8182 × 8									●				211	
		HM6264-12	120	120											●			211	
		HM6264-15	150	150											●			211	
		HM6264L-10	100	100											●			215	
		HM6264L-12	120	120										●			215		
		HM6264L-15	150	150										●			215		
	DRAM	16k-bit	HM4716A-1	NMOS	16384 × 1	120	320	+12, +5, -5,	20m/0.46	16			●	●				222	
			HM4716A-2			150	320						●	●			MK4116-2	222	
HM4716A-3			200			375						●	●			MK4116-3	222		
HM4716A-4			250			410						●	●			MK4116-4	222		
HM4816A-3			100			235						●	●			2118-3	233		
HM4816A-3E			105			200						●	●				233		
HM4816A-4			120			270						●	●			2118-4	233		
HM4816A-7			150			320						●	●			2118-7	233		
64k-bit		HM4864-2	150		270	65536 × 1			+5		20m/0.33	●	●	●					241
		HM4864-3	200		335		●	●				●					241		
		HM4864A-12	120		230		●	●				●					260		
		HM4864A-15	150		260		●	●				●					260		
		HM4864A-20	200		330		●	●				●					260		
		HM4865A-12**	120		230		●	●									270		
		HM4865A-15**	150		260		●	●									270		
		HM4865A-20**	200		330		●	●									270		
256k-bit		HM50256-12**	120		220	262144 × 1					20m/0.35	●							277
		HM50256-15**	150		260		●										277		
		HM50256-20**	200		330		●										277		
		HM50257-12**	120		220		●										284		
		HM50257-15**	150		260		●										284		
		HM50257-20**	200		330		●										284		

* Under development
** Preliminary ΔHM6116LP Series : 10μW
*** The package codes of CC, CG, P, FP and SP are applied to the package materials as follows.
CC : Side-brazed Ceramic Leadless Chip Carrier, CG : Glass-sealed Ceramic Leadless Chip Carrier, G : Cerdip, P : Plastic DIP,
FP : Small Sized Plastic Flat Package(SOP), SP : Skinny Type Plastic DIP

■ MOS ROM

Program	Total Bit	Type No.	Process	Organization (word × bit)	Access Time (ns) max	Supply Voltage (V)	Power Dissipation (W)	Package***				Replacement	Page				
								Pin No.	C	G	P			FP			
Mask	64k-bit	HN61364	CMOS	8192 × 8	250	+5	5μ/0.05	28			●	●	292				
		HN61365			250						●		294				
		HN61366			250						●		296				
	128k-bit	HN43128		16384 × 8 32768 × 4	6500		3m	28			●				298		
		HN613128		16384 × 8	250		5μ/0.05	28			●	●			300		
	256k-bit	HN61256		32768 × 8 65536 × 4	3500		7.5m	28				●	●			302	
		HN613256		32768 × 8	250		5μ/75m					●	●			304	
1M-bit	HN62301**	131072 × 8	350	5m/60m	28	●		●					306				
U. V. Erasable & Electrically	16k-bit	HN462716	NMOS	2048 × 8	450	+5	0.555	24	●	●			2716	310			
		HN462532			4096 × 8				450	0.858		●	●				TMS2532
	HN462732	200		0.788				●	●				2732	318			
	HN482732A-20	250		0.788					●					2732A-2	325		
	HN482732A-25	300							●					2732A	325		
	HN482732A-30	250							●					2732A-3	325		
	64k-bit	HN482764		8192 × 8			250	0.555	28	●	●					2764	328
		HN482764-3			300		●			●					2764-3	328	
		HN482764-4			450		●			●							328
	128k-bit	HN4827128-25**		16384 × 8	250		0.554	28			●					332	
		HN4827128-30**			300						●						332
		HN4827128-45**			450						●						332
	Electrically Erasable	16k-bit		HN48016	NMOS		16384 × 8	350	+5	0.16	24			●			336

* Under development

** Preliminary

*** The package codes of C, G, P and FP are applied to the package materials as follows.

C : Side-brazed Ceramic DIP, G : Cerdip, P : Plastic DIP, FP : Plastic Flat Package

■ MOS MEMORIES OF WIDE OPERATING TEMPERATURE RANGE

Mode	Total Bit	Type No.	Organization (word × bit)	Operating Temperature Range (°C)	Access Time (ns) max	Power Dissipation (W)	Package***			Page	
							Pin No.	P	G		
Static RAM	16k-bit	HM6116I-2	2048 × 8	-40 to +85	120	0.1m/0.18	24		●	●	107
		HM6116I-3			150				●	●	107
		HM6116I-4			200				●	●	107
		HM6116LI-2			120			20μ ² /0.16		●	●
		HM6116LI-3		150		●			●	131	
		HM6116LI-4		200		●			●	131	
		HM6116K-3		150	-55 to +125					●	150
		HM6116K-4		200					●	150	
Dynamic RAM	64k-bit	HM4864I-2	65536 × 1	-40 to +85		150	15m/0.3	16		●	256
		HM4864I-3				200				●	256
		HM4864K-2		150	-55 to +85					●	256
		HM4864K-3		200						●	256
EPROM	32k-bit	HN 462732I	4096 × 8	-40 to +85	450	0.1/0.788	24		●	322	

△ HM6116LPI Series : 10μW

■ BIPOLAR RAM

Level	Total Bit	Type No.	Organization (word × bit)	Output	Access Time (ns) max	Supply Voltage (V)	Power Dissipa- tion (mW/bit)	Package**				Replacement	Page
								Pin No.	F	G	CC		
ECL 10k	256-bit	HM10414	256 × 1	Open Emitter	10	-5.2	2.8	16		●		F10414	342
		HM10414-1			8					●			342
	1k-bit	HM2110	1024 × 1		35		0.5		●		F10415	346	
		HM2110-1			25				●		F10415A	346	
		HM2112			10		0.8		●				
		HM2112-1			8				●				
		HM10422			256 × 4		10	0.8	24	●	●	F10422	355
		HM10422-7					7		●	●		360	
	4k-bit	HM10470	4096 × 1		25		0.2	18	●	●	F10470	363	
		HM10470-1			15					●			363
		HM10470-15			15					●			368
		HM2142			10		0.3			●			371
		HM10474			25				0.2	24	●	●	F10474
		HM10474-15			15		●			●		374	
	16k-bit	HM10480	16384 × 1		25		0.03	20	●	●	F10480	379	
	ECL 100k	1k-bit	HM100415		1024 × 1		10	-4.5	0.6	16		●	●
HM100422			256 × 4	10	0.8	24	●		●	●	F100422	385	
4k-bit		HM100470	4096 × 1	25	0.2	18			●		F100470	388	
		HM100470-15		15					●			388	
		HM100474		1024 × 4	25		0.2		24	●	●	F100474	391
		HM100474-15			15					●	●		391
16k-bit		HM100480*	16384 × 1	25	0.05	20	●		●	F100480	396		
TTL		256-bit	HM2504	256 × 1	Open Collector	55	1.8		16		●		93411
	HM2504-1		45					●			93411A	399	
	1k-bit	HM2510	1024 × 1	70		0.5		●				403	
		HM2510-1		45				●			93415	403	
		HM2510-2		35				●			93415A	403	
		HM2511		70		0.5		●				407	
		HM2511-1		45			3-state			●		93425	407

* Preliminary

** The package codes of F, G and CC are applied to the package material as follows.
F : Flat Package, G : Cerdip, CC : Side-brazed Ceramic Leadless Chip Carrier

■ BIPOLAR PROM

Level	Total Bit	Type No.	Organi- zation (word × bit)	Output	Access Time (ns) max	Supply Voltage (V)	Power Dissi- pation (mW)	Package*				Replacement	Page
								Pin No.	F	G	P		
TTL	4k-bit	HN25044	1024×4	O/C	50	+5	500	18		●		82S136	414
		HN25045		3-s						●		82S137	414
	8k-bit	HN25084	2048×4	O/C	60		550	18		●		82S184	419
		HN25085		3-s						●		82S185	419
		HN25084S		O/C	50					●			422
		HN25085S		3-s						●			422
		HN25088		O/C					1024×8	60		●	
		HN25089	3-s		●			82S181			425		
		HN25088S	O/C	50			●				428		
		HN25089S	3-s				●				428		
		HN25088L	O/C		100			●				431	
		HN25089L	3-s				●			431			
	16k-bit	HN25168S	2048×8	O/C	60		600	24		●		82S190	434
		HN25169S		3-s						●		82S191	434

* The package code of G is applied to the material as follows.
G : Cerdip

PACKAGE INFORMATION (Dimensions in mm)

● Dual-in-line Plastic

● DP-16

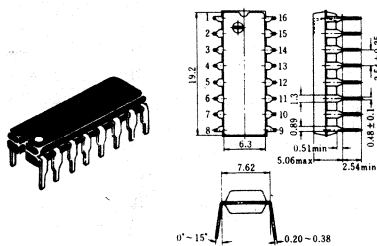

● DP-18

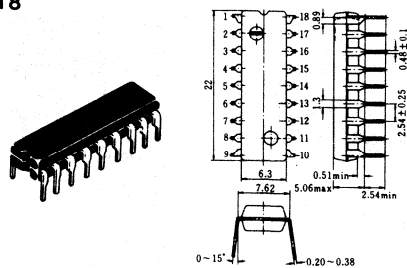

● DP-20

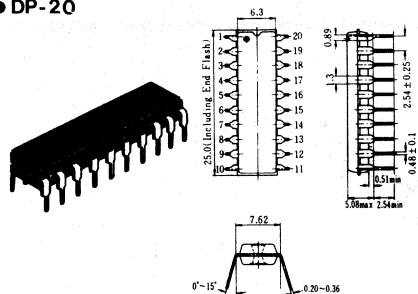

● DP-24

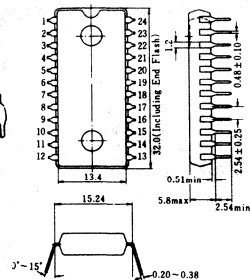

● DP-24A

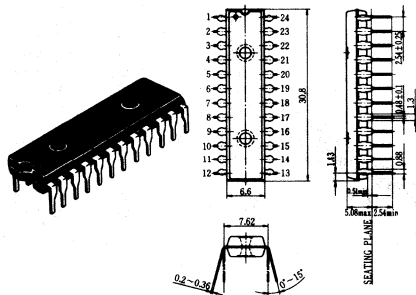

● DP-28

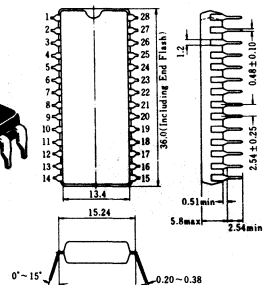

Applicable ICs

DP-16	HM4716AP-1, HM4716AP-2, HM4716AP-3, HM4716AP-4, HM4816AP-3, HM4816AP-3E, HM4816AP-4, HM4816AP-7, HM4864P-2, HM4864P-3, HM4864AP-12, HM4864AP-15, HM4864AP-20, HM4865AP-12, HM4865AP-15, HM4865AP-20
DP-18	HM4334P-3, HM4334P-4, HM4334P-3L, HM4334P-4L, HM6148P, HM6148P-6, HM6148LP, HM6148LP-6, HM6148HP-35, HM6148HP-45, HM6148HP-55, HM6148HLP-35, HM6148HLP-45, HM6148HLP-55, HM6147P, HM6147P-3, HM6147LP, HM6147LP-3, HM6147HP-35, HM6147HP-45, HM6147HP-55, HM6147HLP-35, HM6147HLP-45, HM6147HLP-55
DP-20	HM6168HP-45, HM6168HP-55, HM6168HP-70, HM6168HLP-45, HM6168HLP-55, HM6168HLP-70, HM6167P, HM6167P-6, HM6167P-8, HM6167LP, HM6167LP-6, HM6167LP-8, HM6167HP-45, HM6167HP-55, HM6167HLP-45, HM6167HLP-55
DP-24	HM6116P-2, HM6116P-3, HM6116P-4, HM6116LP-2, HM6116LP-3, HM6116LP-4, HM6116AP-10, HM6116AP-12, HM6116AP-15, HM6116AP-20, HM6116ALP-10, HM6116ALP-12, HM6116ALP-15, HM6116ALP-20, HM6117P-3, HM6117P-4, HM6117LP-3, HM6117LP-4, HM61365P, HM61366P, HM61366P, HM6116PI-2, HM6116PI-3, HM6116PI-4, HM6116LPI-2, HM6116LPI-3, HM6116LPI-4
DP-24A	HM6116ASP-10, HM6116ASP-12, HM6116ASP-15, HM6116ASP-20, HM6116ALSP-10, HM6116ALSP-12, HM6116ALSP-15, HM6116ALSP-20
DP-28	HM6264P-10, HM6264P-12, HM6264P-15, HM6264LP-10, HM6264LP-12, HM6264LP-15, HN61364, HN43128P, HN613128P, HN61256P, HN613256P, HN62301P

Package Information

● CERDIP

● DG-16

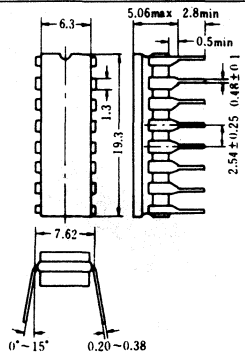
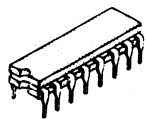

● DG-16A

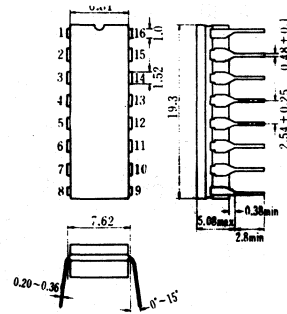
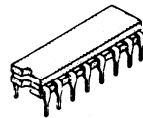

● DG-16B

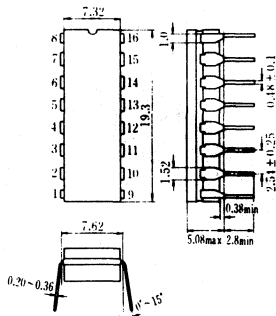
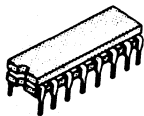

● DG-18

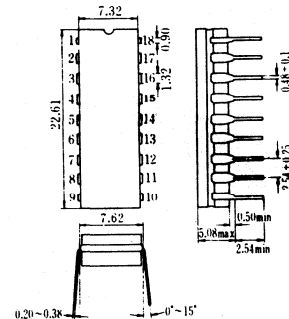
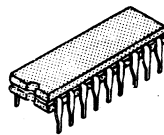

● DG-20

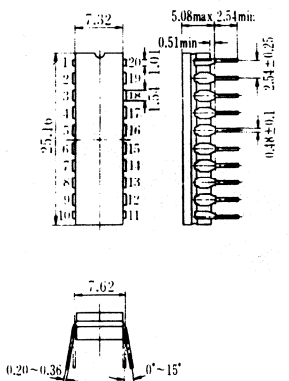
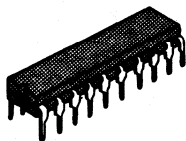

● DG-24

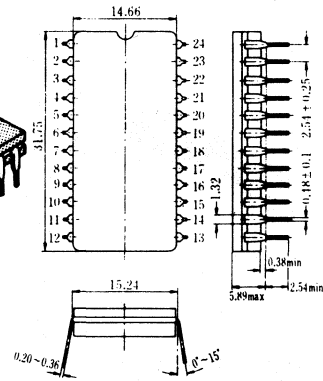
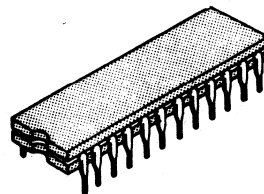

● DG-24A

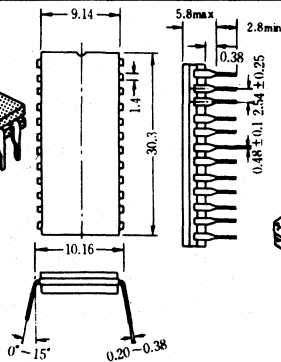
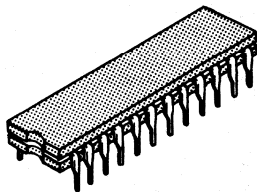

● DG-24B

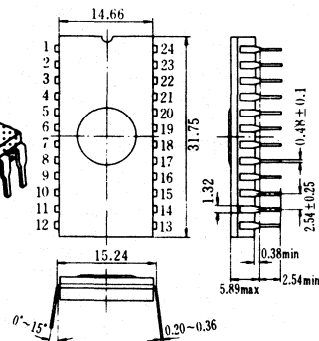
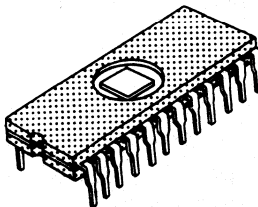

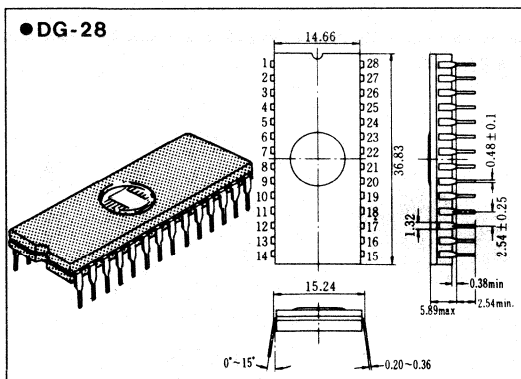

Applicable ICs

DG-16	HM10414, HM10414-1, HM2504, HM2504-1, HD2912
DG-16A	HM4716A-1, HM4716A-2, HM4716A-3, HM4716A-4, HM2110, HM2110-1, HM2112, HM2112-1, HM100415, HM2510, HM2510-1, HM2510-2, HM2511, HM2511-1, HD2916, HD2923
DG-16B	HM4816A-3, HM4816A-3E, HM4816A-4, HM4816A-7, HM4864-2, HM4864-3, HM4864A-12, HM4864A-15, HM4864A-20, HM50256-12, HM50256-15, HM50256-20, HM50257-12, HM50257-15, HM50257-20, HM4864I-2, HM4864I-3, HM4864K-2, HM4864K-3
DG-18	HM4334-3, HM4334-4, HM6148, HM6148-6, HM6148H-35, HM6148H-45, HM6148H-55, HM6147, HM6147-3, HM6147H-35, HM6147H-45, HM6147H-55, HM10470, HM10470-1, HM10470-15, HM2142, HM100470, HM100470-15, HN25044, HN25045, HN25084, HN25085, HN25084S, HN25085S
DG-20	HM6168H-45, HM6168H-55, HM6168H-70, HM6167, HM6167-6, HM6167-8, HM6167H-45, HM6167H-55, HM10480, HM100480
DG-24	HM6116-2, HM6116-3, HM6116-4, HM6116L-2, HM6116L-3, HM6116L-4, HM6116I-2, HM6116I-3, HM6116I-4, HM6116LI-2, HM6116LI-3, HM6116LI-4, HM6116K-3, HM6116K-4, HN25088, HN25089, HN25088S, HN25089S, HN25088L, HN25089L, HN25168S, HN25169S
DG-24A	HM10422, HM10422-7, HM10474, HM10474-15, HM100422, HM100474, HM100474-15
DG-24B	HN462716G, HN462532G, HN462732G, HN482732AG-20, HN482732AG-25, HN482732AG-30, HN462732GI
DG-28	HN482764G, HN482764G-3, HN482764G-4, HN4827128G-25, HN4827128G-30, HN4827128G-45

● **Side-brazed Ceramic DIP**

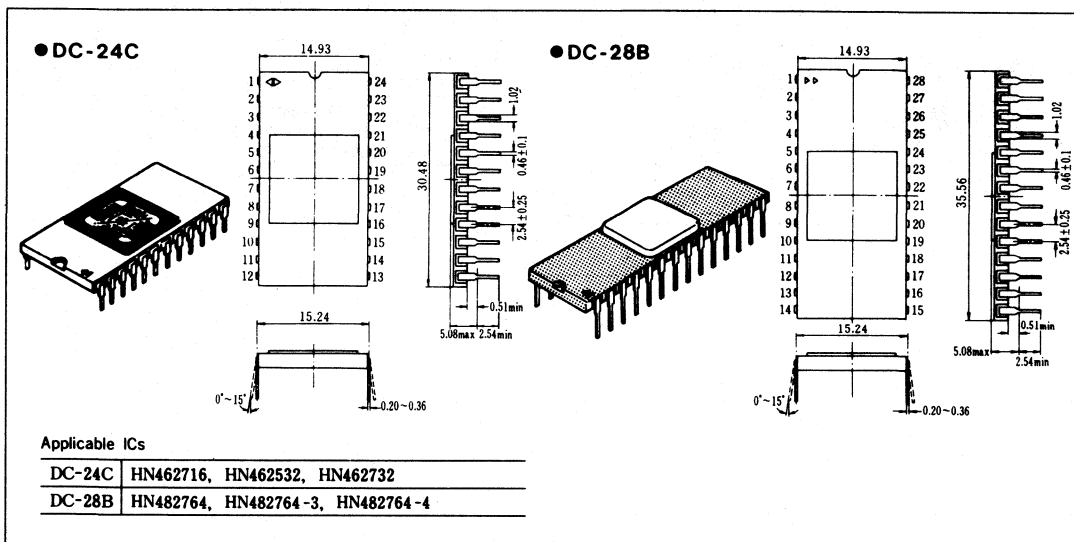

● Flat Packages

● FP-24

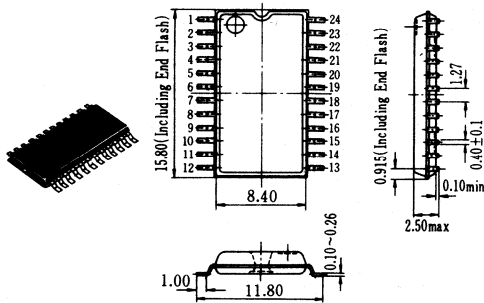

● FP-54

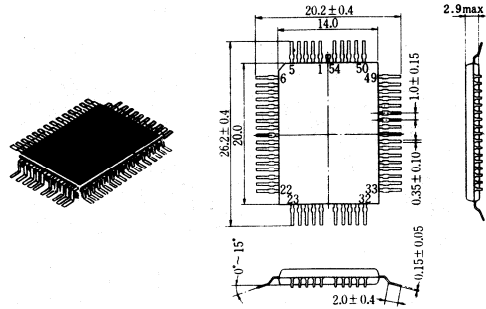

● FG-18

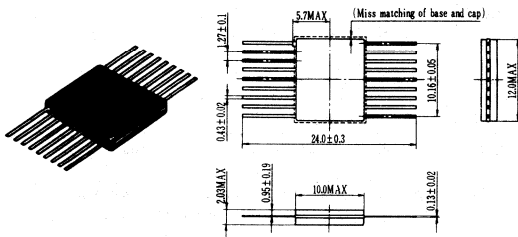

● FG-20

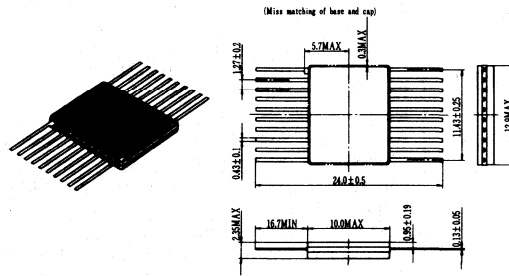

● FG-24

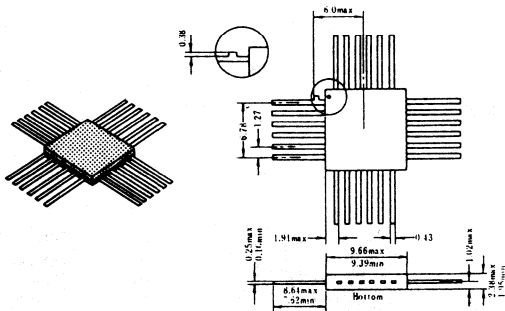

● Applicable ICs

FP-24	HM6116FP-2, HM6116FP-3, HM6116FP-4, HM6116LFP-2, HM6116LFP-3, HM6116LFP-4, HM6117FP-3, HM6117FP-4, HM6117LFP-3, HM6117LFP-4
FP-54	HN61364FP, HN613128FP, HN61256FP, HN613256FP
FG-18	HM10470F
FG-20	HM10480F, HM100480F
FG-24	HM10422F, HM10422F-7, HM10474F, HM10474F-15, HM100422F, HM100474F, HM100474F-15

● Leadless Chip Carrier

● CC-18

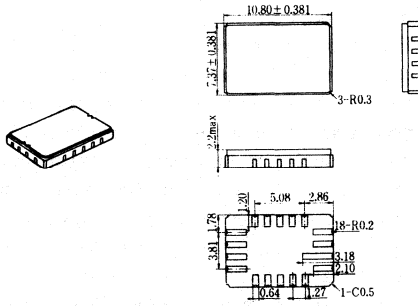

● CC-24

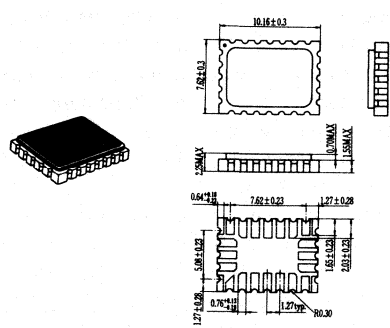

● CG-18

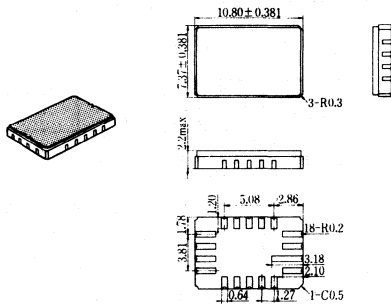

● CG-20

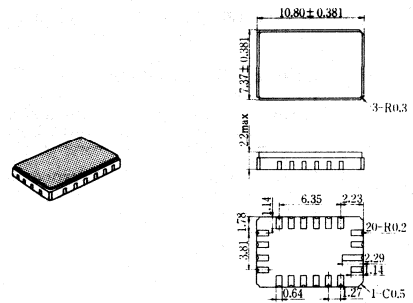

● CG-32

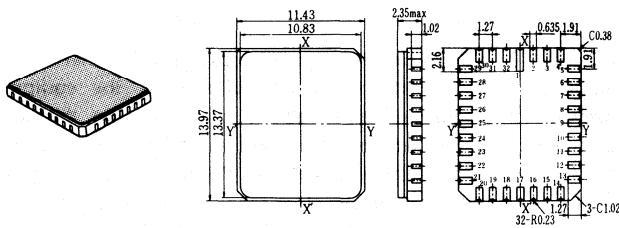

● Applicable ICs

CC-18	HM4864CC-2, HM4864CC-3
CC-24	HM100415CC, HM100422CC
CG-18	HM4864ACG-12, HM4864ACG-15 HM4864ACG-20
CG-20	HM6167HCG-45, HM6167HCG-55
CG-32	HM6116CG-2, HM6116CG-3, HM6116CG-4

RELIABILITY OF HITACHI IC MEMORIES

1. STRUCTURE

IC memories are structurally classified into bipolar type and MOS type. The former has a characteristic of an extremely high speed. But it is a comparatively small capacity and on the other hand, the latter features a large capacity. These IC memories are utilized by effectively taking the most of their respective characteristics.

Flows from designing, manufacturing and up to inspection for both Bipolar and MOS type IC memories are established under a unified concept, design and inspection standards. Therefore stable results concerning their reliability have been obtained with these IC memories, regardless of differences in the circuit design, pattern, layout, degree of

integration, etc.

From its characteristics, the memory LSI is integrated in high density by unit patterns called "cell" and it is not exaggeration to say that they are produced in the most advanced semiconductor manufacturing technologies. To get the high reliability of such a memory which has been subjected to rapid technological advances, know-hows based on past experience from the design stage of a cell are incorporated. Farther to evaluated reliability of each respective technology applied. Reliability evaluation using TEG (Test Element Group), etc. is carried out. Examples of cell circuits of the Bipolar memory and MOS memory are shown in Table 1.

● Table 1 Examples of Basic Cell Circuit of IC Memories

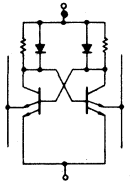
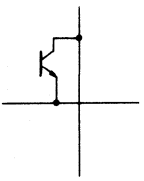
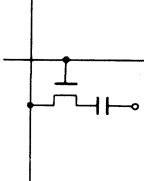
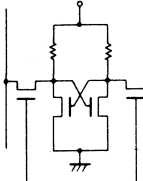
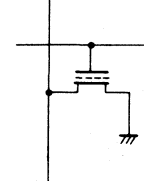
Classification	Bipolar memory (RAM)	Bipolar memory (PROM)	NMOS memory (Dynamic RAM)	NMOS, CMOS memories (Static RAM)	NMOS memory (PROM)
Application	Buffer memory, control memory of high-speed computer	Microcomputer control use	Main memory of computer, microcomputer memory		For microcomputer control
Example of basic cell circuit					

IC memory chips produced in the latest technologies are sealed in different packages. Ceramic package, Cerdip (glass-sealed type) and Plastic package are the current major IC packages. Also such packages as LCC (Leadless Chip Carrier) for high package density and SO (Small Outline) package are now under development.

Ceramic and Cerdip versions, with their hermetically sealed structure, are suitable to the equipment requiring high reliability. Plastic version, the leading semiconductor package, is applied to various kinds of equipment. Hitachi Plastic package has been improved to the close reliability level as the hermetically sealed devices. Table 2 shows examples of IC memory package outlines.

● Table 2 Examples of IC Memory Package Outlines

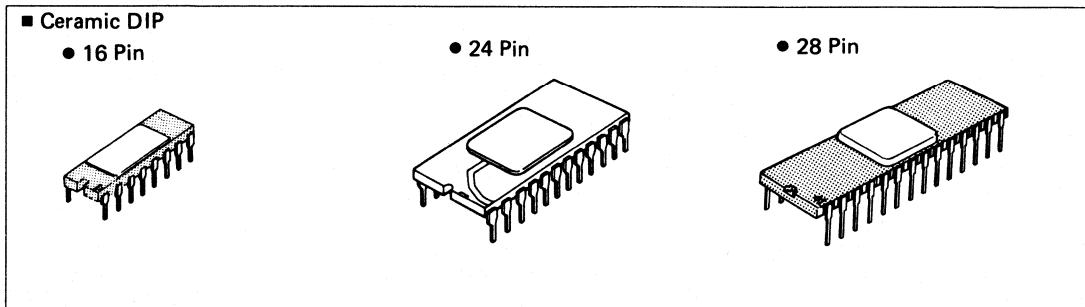

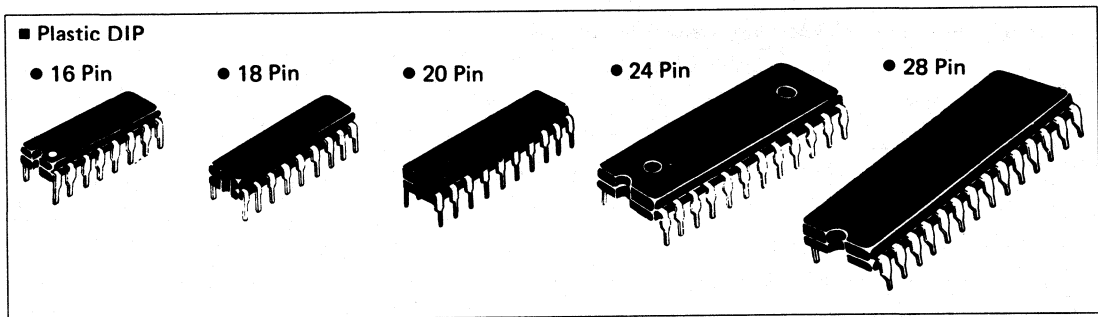
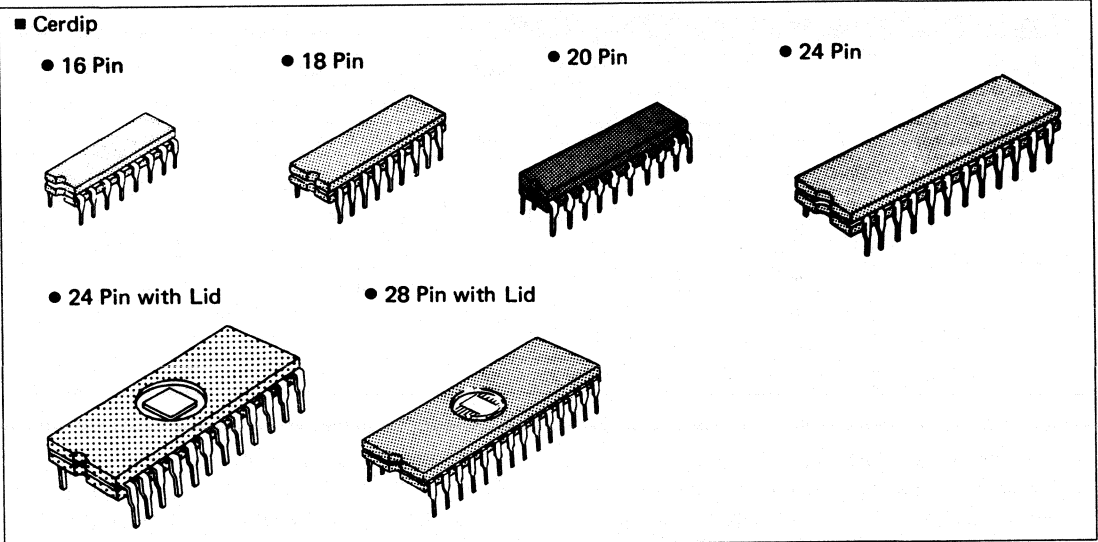

2. RELIABILITY DATA Results of reliability tests are listed below.

2-1 Reliability test data on Bipolar memories

The reliability test data on the Bipolar memories are shown in Tables 3 and 4. Since they are manufactured under the aforementioned standardized design

rules and quality control, there is no difference in reliability among various types. In addition, it can be said that the greater the capacity, the higher the reliability per bit.

● Table 3 Results on Bipolar Memory Reliability Tests (1)

Test item	Test condition	HM10470 (Cerdip)				HM100422 (Chip Carrier)				HN25089 (Cerdip)			
		samples	Total component hours	Failures	Failure rate*	Samples	Total component hours	Failures	Failure rate*	Samples	Total component hours	Failures	Failure rate*
High-temperature (Operating)	$T_a = 125^\circ\text{C}$ $V_{EE} = -5.2\text{V}$ (HM10470) $V_{CC} = 5.5\text{V}$ (HN25089)	125	C. H.	0	1/hr 2.3×10^{-4}	—	—	—	—	36	C. H.	0	1/hr 2.6×10^{-4}
	$T_a = 150^\circ\text{C}$ $V_{EE} = -5.2\text{V}$ (HM10470) $V_{EE} = -5.0\text{V}$ (HM100422) $V_{CC} = 5.5\text{V}$ } (HN25089) $t_{cyc} = 1 \mu\text{s}$	80	2.7×10^5	0	3.4×10^{-6}	40	4×10^4	0	2.3×10^{-5}	10	1.0×10^4	0	9.2×10^{-5}
High-temperature storage	$T_a = 200^\circ\text{C}$	27	2.7×10^5	0	3.4×10^{-5}	40	4×10^4	0	2.3×10^{-5}	15	1.5×10^4	0	6.1×10^{-5}
	$T_a = 295^\circ\text{C}$	20	2.0×10^5	0	4.6×10^{-5}	40	4×10^4	0	2.3×10^{-5}	15	1.5×10^4	0	6.1×10^{-5}

* Estimated failure rate with confidence level 60%

● Table 4 Results on Bipolar Memory Reliability Tests (2)

Test item	Test condition	HM10470 (Cerdip)		HM100422 (Chip carrier)		HN25089 (Cerdip)	
		Samples	Failures	Samples	Failures	Samples	Failures
Temperature cycling	-65°C ~ +150°C, 10 cycles	120	0	40	0	45	0
Soldering heat	260°C, 10 seconds	22	0	—	—	22	0
Thermal shock	0°C ~ +100°C, 10 cycles	36	0	20	0	22	0
Mechanical shock	1500G, 0.5 ms, Three times each for X, Y and Z	30	0	60	0	22	0
Variable frequency	100~2000Hz, 20G Three times each for X, Y and Z	40	0	60	0	22	0
Constant-acceleration	20000G, 1 minute, each for X, Y and Z	40	0	60	0	22	0

2-2 Reliability test data on MOS memories

The reliability test data on the MOS memories are shown in Tables 5, 6 and 7. In these tables, data are shown on representative types of HM4864 (64K

DRAM), HM4716AP (16K DRAM), HM6116P (16K SRAM), HM6147P (4K SRAM), HN462732, HN462532 (32K EPROM), HN462716 (16K EPROM)

● Table 5 Results on MOS Memory Reliability Tests (1)

Test item	Test condition	HM4864 (Ceramic)				HN462532/HN462732 (Cerdip)				Remarks
		Samples	Total component hours	Failures	Failure rate*	Samples	Total component hours	Failures	Failure rate*	
High-temperature dynamic operation	Ta=125°C V _{CC} =5.5V t _{cyc} =3μs	1872	C.H. 3.33×10 ⁶	3*1	1/hr 1.25×10 ⁻⁶	100	C.H. 1.0×10 ⁵	0	1/hr 9.2×10 ⁻⁶	*1 Oxide failure × 2 Unknown × 1
High-temperature storage	Ta=200°C	20	4.0×10 ⁴	0	2.3×10 ⁻⁵	140	1.4×10 ⁵	0	6.6×10 ⁻⁶	
High-temperature storage	Ta=259°C	—	—	—	—	100	5.0×10 ⁴	0	1.8×10 ⁻⁵	
High-temperature storage	Ta=295°C	—	—	—	—	100	4.2×10 ⁴	1*2	4.8×10 ⁻⁵	*2 Data disappearance

* Estimated failure rate with confidence level 60%

● Table 6 Results on MOS Memory Reliability Tests (2)

Test item	Test condition	HM4716AP (Plastic)				HM6116P/HM6147P (Plastic)				Remarks
		Samples	Total component hours	Failures	Failure rate*	Samples	Total component hours	Failures	Failure rate*	
High-temperature dynamic operation	Ta=125°C V _{DD} =13.2V (NMOS) V _{CC} =5.5V (CMOS) t _{cyc} =3μs	2330	C.H. 3.46×10 ⁶	6*1	1/hr 2.12×10 ⁻⁶	1216	C.H. 1.90×10 ⁶	3*2	1/hr 2.19×10 ⁻⁶	*1 Oxide failure × 6 *2 Oxide failure × 1 Electrostatic discharge × 1 Unknown × 1
High-temperature storage	Ta=150°C	45	4.5×10 ⁴	0	2.0×10 ⁻⁵	20	2.0×10 ⁴	0	4.6×10 ⁻⁵	
High-temperature and high-humidity bias	Ta=85°C, RH=85% V _{DD} =12V (NMOS) V _{CC} =5.5V (CMOS)	3081	6.2×10 ⁶	19*3	3.1×10 ⁻⁶	630	1.3×10 ⁶	4*4	4.0×10 ⁻⁶	*3 Aluminium corrosion × 17 Unknown × 2 *4 Aluminium corrosion × 3 Unknown × 1

* Estimated failure rate with confidence level 60%.

● Table 7 Results on MOS Memory Reliability Tests (3)

Test item	Test condition	HM4864 (Ceramic)		HM4864 (Cerdip)		EPROM (Cerdip)		HM4716AP		HM6116P/HM6147P	
		Samples	Failures	Samples	Failures	Samples	Failures	Samples	Failures	Samples	Failures
Temperature cycling	-65°C~RT~150°C 10 cycles	1208	0	260	0	50	0	—	—	—	—
Temperature cycling	-55°C~RT~150°C 10 cycles	—	—	—	—	310	0	7892	0	2080	0
Temperature cycling	-55°C~150°C 1000 cycles	164	0	100	0	50	0	600	0	—	—
Thermal shock	-65°C~150°C 15 cycles	22	0	60	0	72	0	190	0	—	—
Thermal shock	0°C~100°C 15 cycles	—	—	—	—	197	0	138	0	60	0
Soldering heat	260°C, 10 seconds	22	0	22	0	22	0	128	0	60	0
Mechanical shock	1,500G, 0.5ms	22	0	38	0	38	0	—	—	—	—
Variable frequency	20~2,000Hz, 20G	22	0	38	0	38	0	—	—	—	—
Constant-acceleration	20,000G	22	0	38	0	38	0	—	—	—	—

2.3 Change of electrical characteristics under endurance test for IC memories

The degradation of I_{CBO} of the cell transistor, degradation of h_{FE}, etc., can be considered as main factors in the internal elements for reliability of Bipolar memories. In actual element designing,

however, it has been designed to operate in the range at which these degradations do not happen. Therefore changes of electrical characteristics including access time are not observed. Time dependence in access time for HM10470 is shown in Fig. 1.

Fig. 1 Example of Change in Bipolar Memory Characteristics

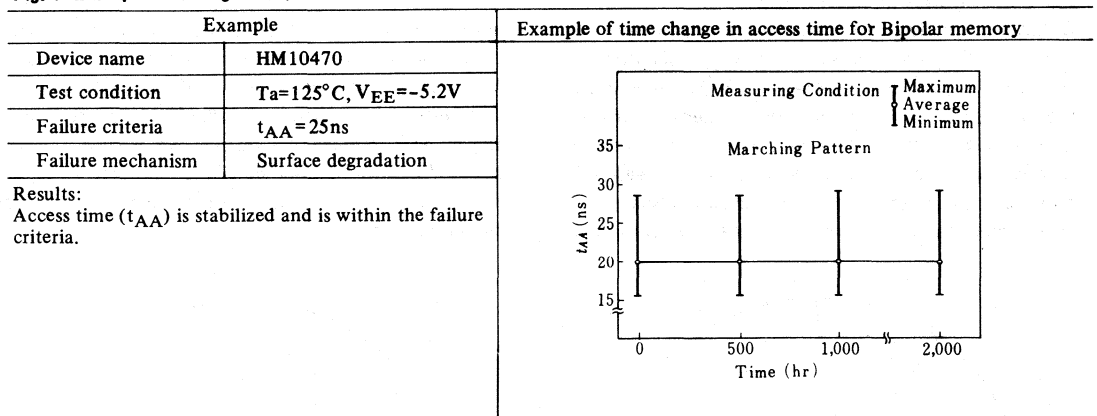

V_{TH} is a basic parameter in the MOS memories, however, it has been confirmed there is not any shift in V_{TH} for practical usage because we have applied surface stabilizing technique, clean process, etc.

In case of dynamic RAM which needs refresh cycle, refresh time is also stabilized owing to the above-mentioned process. Time dependence of V_{CC min} and t_{REF} characteristics for the 64K DRAM are shown in Fig. 2 and 3.

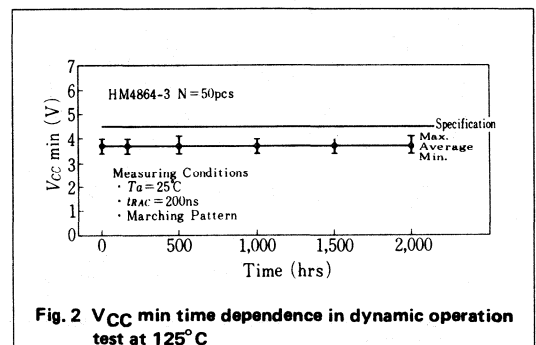

Fig. 2 V_{CC min} time dependence in dynamic operation test at 125°C

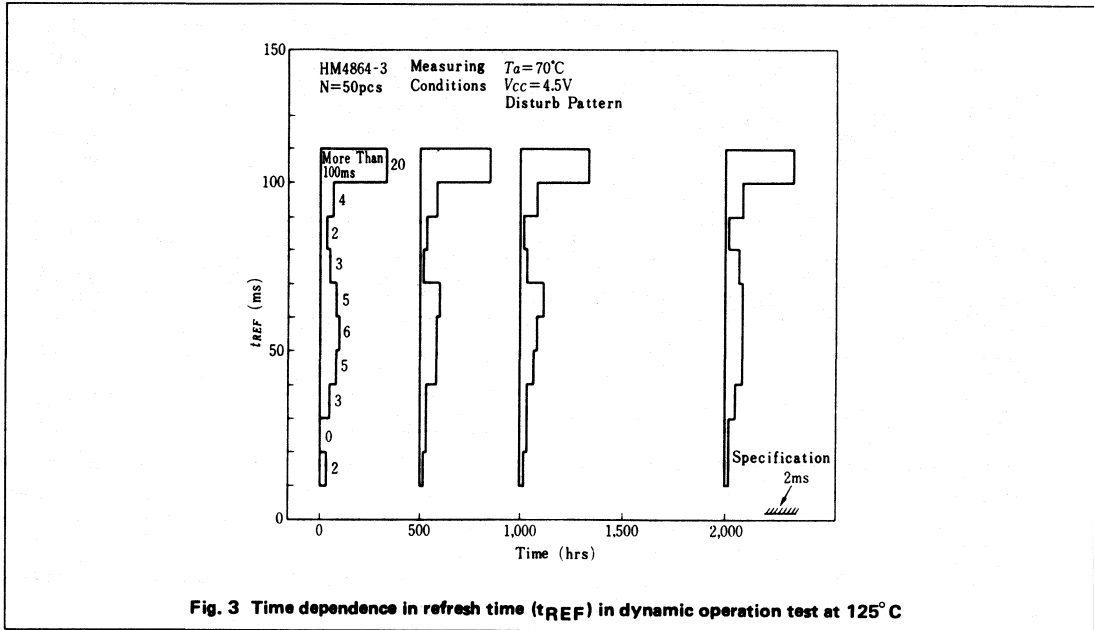

Fig. 3 Time dependence in refresh time (t_{REF}) in dynamic operation test at 125°C

2.4 Classification of failure modes

Examples of failures happened in the field are shown in Fig. 4 and 5. Since memory LSIs generally require the most fine processing in semiconductor manufacturing technology, the percentage of failures resulting from pinholes, photoresist defects, foreign materials, etc., is tending to increase. To eliminate the latent defects which are generated in these manufacturing processes, we are constantly

improving these processes, and performing burn-in screening under high temperature for all memories. In addition, since the analysis of failures in the field can result in important feedback to improve their design and manufacturing, we are always exerting our efforts to collect customer process data and field data with the aim of further establishing their high reliability.

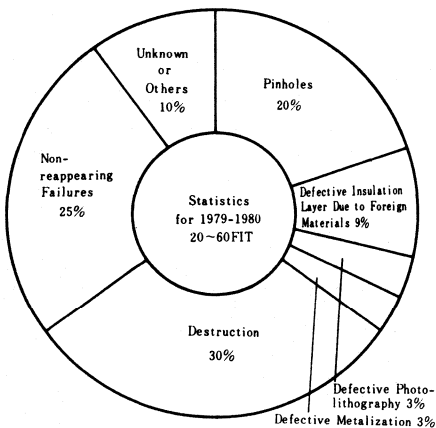

Fig. 4 Classification of Failure Modes of Bipolar Memory in the field

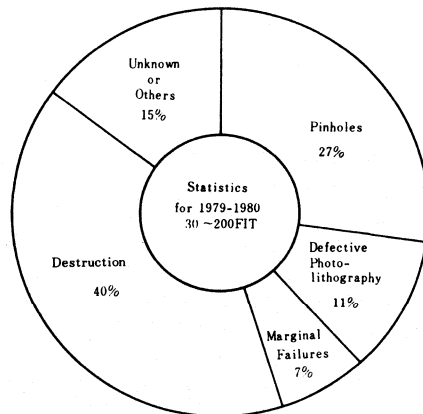

Fig. 5 Classification of Failure Modes of MOS Memory in the field

3. SOFT ERROR

3.1 Soft Error Mechanism

As mentioned before, IC memories have been increasingly miniaturized. Miniaturization, which means reduction of the horizontal plane dimensions as well as the vertical dimensions, causes signal level on the chip and storage charge of dynamic memories to be also decreased. An obstacle lying before miniaturization is soft error. Soft errors can be characterized as "transitory failures in which normal memory operation can be recovered by reprogramming information." Soft errors are caused by α -particles emitted from U and T_H contained in the packaging materials. As memory chips are exposed to α -particles, a great deal of electron-hole pairs are induced in Si substrate. These induced electrons cause memory information reversion. Fig. 6 shows the mechanism of information reversion in NMOS dynamic memory by α -particles. In case of NMOS dynamic memory, negative voltage is applied to the Si substrate. Therefore, positive holes are drawn by substrate, and only electrons cause information reversion (from information "1" to "0") of memory

cell. Fig. 6 shows misoperation seen in memory cell. Such a failure mode, which is defined as "Memory cell mode of soft errors," is distinguished from "Bit line mode." "Bit line mode" of soft errors is shown in Fig. 7. As information in memory cell is read out on bit line, bit line potential changes depending on memory cell information. The changing value is very small (several 100 mV), and compared with standard potential (potential read out from dummy cell), it is amplified by sense amplifier. If bit line is exposed to α -particles during the very short period between read-out from memory cell and amplification by sense amplifier, bit line potential decreases. And as it becomes less than standard potential, misoperation from information "0" to "1" will take place. On the other hand, with decrease of standard potential, misoperation from information "1" to "0" is seen. Both are called "Bit line mode" because errors appear at irradiation of α -particles. Soft error dependence on cycle time is shown in Fig. 8.

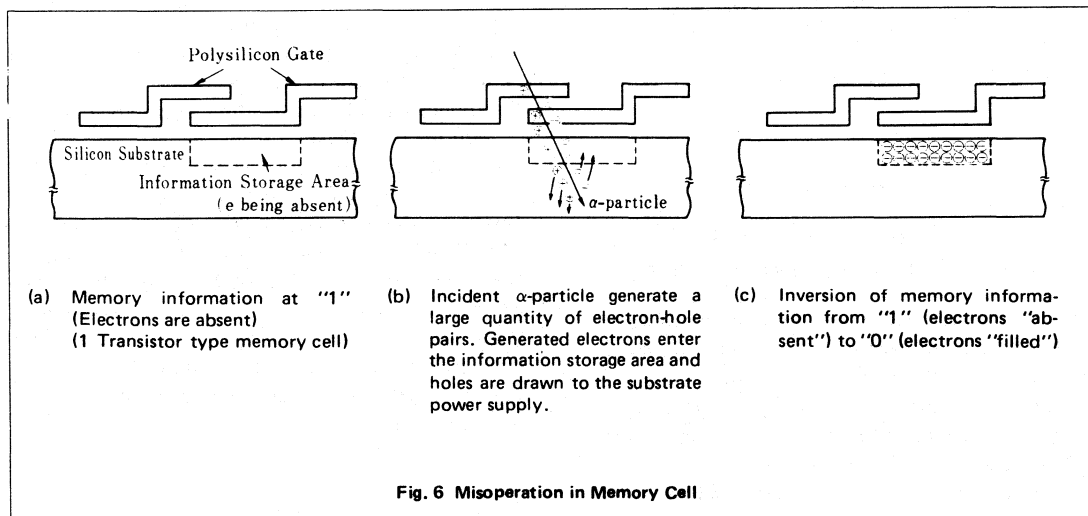

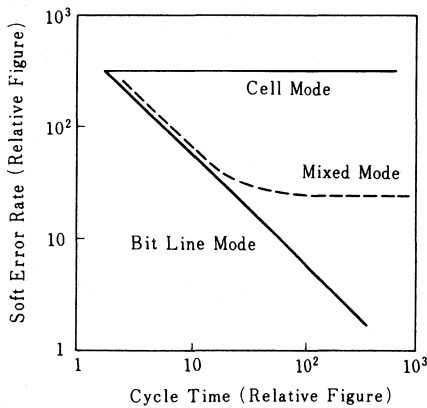
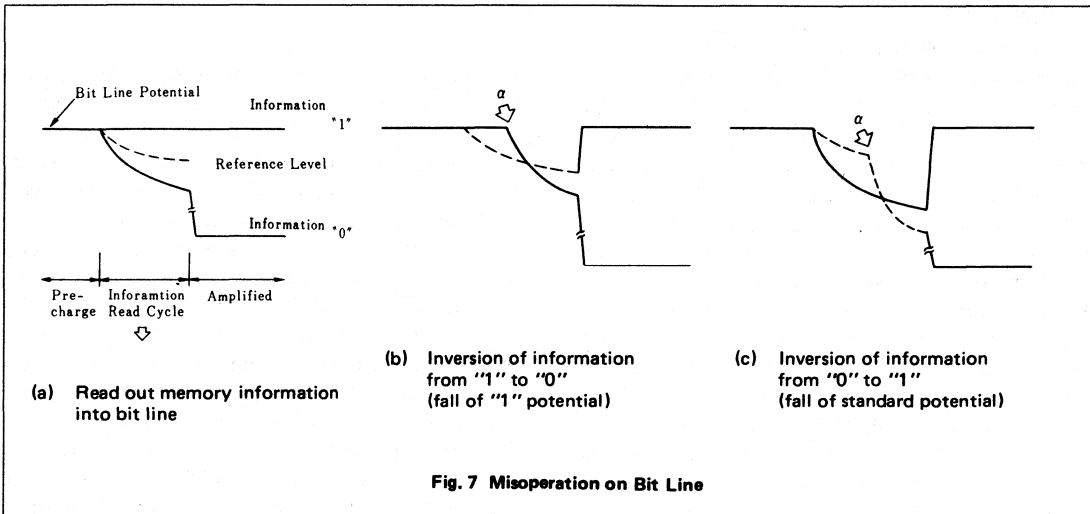

3.2 Examples of soft error preventive measures in products

At the initial stage of the 64K DRAM development, its soft error rate was estimated from accelerated irradiation test data to be higher than the expected design value. Hitachi has performed the following soft error preventive measures.

- 1) Selection of packaging materials which emit a minimal number of α -particles.
- 2) Application of chip coating technology to prevent the α -particles.
- 3) Use of circuitry and layout technology with inherent ability to resist α -particles.

Owing to these corrective measures, soft errors in 64K DRAM have reached a practically acceptable level. Preventive measures applied for 64K DRAM are also applied to other types. 16K DRAM with single power supply 5V family, for which chip coating was originally used, no longer requires this coating because of remarkable improvement by the third measure.

Actual products will have three types of failure modes, that is, cell mode, bit line mode and mixture of both modes. Soft error mechanism of static MOS memories and of bipolar memories are different from the above-mentioned mechanism in dynamic MOS memories.

In case of static memory, certain level of current always flows through the cell in order to retain the data in flip-flop circuit. When partial current induced by α -particles exceeds the retention current, misoperation occurs because of reversion of flip-flop circuit.

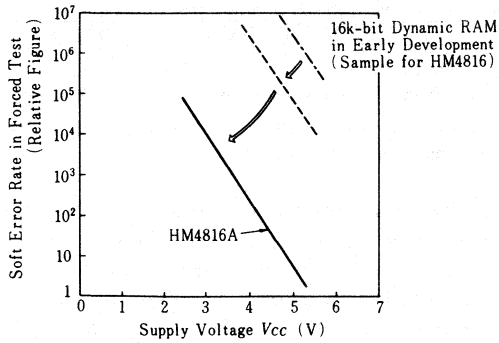

Fig. 9 Example of Soft Error Improvement on 16K-bit Dynamic RAM

3.3 Request for soft error preventative measures in system equipment

Thus our efforts to reduce soft errors have resulted in almost trouble-free memories. System reliability can be more improved by supplying some functions, that is, ECC device for large memory system and parity bit for small one.

4. RELIABILITY CLASSIFICATION

In designing IC memories, Hitachi classifies memory reliability by their application and controls the flows of design, production and test. Reliability can be roughly classified as follows:

- (I) For large scale computers and electronic exchangers
- (II) For important parts for auto-motive application
- (III) General communication-industrial use

In using our products, therefore, we would like you to consider the classification of the application. Especially, when you are going to apply our memories to any special equipment, please do not hesitate to consult our sales engineering staff.

A variety of IC memories of high-speed, high-power and static lower power dissipation CMOS have been developed and commercially available, which allows an electronics designer to properly select the one best suited for a particular application. However, he must be familiar with the advantages and disadvantages of the devices to make the optimum selection and to prevent them from malfunctioning or, in the worst case, from breaking down. Precautions for handling IC memories given below will help the electronics designers to work out their optimum circuit designs.

1. BIPOLAR IC MEMORY

1.1 Prevention of static electricity

Bipolar memories have been considered to have high resistance to the static electricity than MOS ICs. However, the presently available high speed IC, represented by bipolar memories, must be provided with a suitable preventive measure against the static electricity. Because their diffused junctions have become thinner than the conventional types, in order to perform higher capability. Take note of the following points.

- (1) Keep all terminals of a device in the conductive mat during transportation and storage to keep them at the same potential. A conductive mat called "MOSPAK" is commercially available. Unless otherwise specially stated, all HITACHI IC memories will be shipped in our conductive mats. Store them as they are.
- (2) When handling by hand IC memories for inspection or connection, his finger must be grounded as shown in Fig. 1. Do not forget to insert a 1M ohm resistor to protect him against an electric shock.

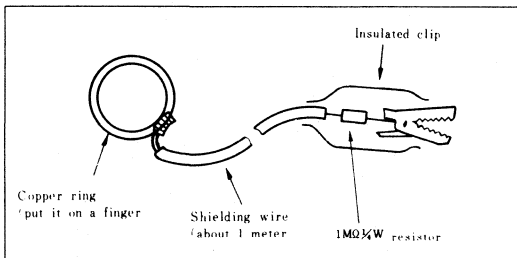

Fig. 1

- (3) It is advisable to control the ambient relative humidity at about 50 per cent to prevent the occurrence of static electricity.
- (4) It is also recommendable to wear cotton clothes instead of the ones made of synthetic fabrics to prevent the static electricity from occurring.

- (5) It is desirable to ground the soldering iron tips. Use a low voltage soldering iron (12 or 24V), if possible.
- (6) When IC memories mounted on the circuit boards are shipped, it is preferable to pack them with conductive mats.

1.2 Prevention of Reverse Insertion of IC Pinouts

In the case of reverse insertion of IC pinouts to board, ICs which have symmetrical pinouts between V_{EE} and Ground causes high current flow. Interconnection on the chip is melted and device is destroyed. Precaution must be made even for the ICs which do not have symmetrical pinouts between V_{EE} and Ground, because excess current flows and sometimes device is destroyed. On the device package, marking of No. 1 pin is stamped. Please watch this marking and insert ICs properly.

1.3 Mounting and Removal of ICs during Voltage is supplied

Usually, rather high current flows in regulator of bipolar memory. Therefore, if ICs are put in and pulled out to board during voltage is supplied, high voltage induced at current on/off destroys ICs. Mount and remove ICs after supply voltage is cut off. Same precaution must be made in measurement with tester.

1.4 Prevention of Oscillation

ECL bipolar memory has high cut-off frequency of transistor. Therefore, sometimes, oscillation is caused in relation with external circuit, and misoperation of ICs is occurred. In such cases, about 0.1 μ F of capacitor, which has good high frequency characteristics, is recommended to put between ICs and voltage supply line.

1.5 Precaution on Simple "H" Level of ECL Memory

In some cases, it is seen that input of ICs is directly connected to ground to fix input as "H" level. However, it sometimes causes misoperation in conjunction with internal circuit composition. "H" and "L" level of input are specified as $V_{IL(min)}$ and $V_{IH(max)}$ for ICs respectively. Please refer them and use ICs properly.

1.6 Cooling

Power dissipation of bipolar memory is 400mW to 1000mW depending on products. In the case many bipolar memories are mounted on the board, natural convection is insufficient for cooling. Therefore, please run forced air cooling with velocity higher

than 2.5m/s. In addition, by cooling, improvement of reliability can be expected as shown in Fig. 2. We recommend the junction temperature to be kept less than 85°C for high reliability use.

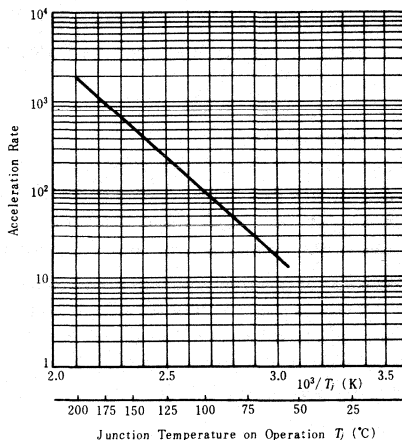

Fig. 2 Example of derating of ECL

1.7 Other Precautions

(1) Deforming of magazine and carrier

Since material of plastic magazine and carrier (for ECL flat package) is usually thermal plasticity, they deforms at temperature higher than 40 to 50°C and may not perform sufficiently. If burn-in is carried out at users, please use aluminum magazine or other metal fixtures.

(2) Shock at transportation

Glass sealed type package is fragile. Usual handling and drop test (JIS C7021 A-8) on individual devices do not cause any problem. However, it devices packed in magazine receive strong shock such as drop shock, devices hit neighbouring devices and packages may be damaged. Therefore, at transportation or loading on/off, be careful not to drop them. Even after devices are mounted on board, IC packages may be damaged if strength of board is not enough and board receives strong deforming stress. Please be careful on strength of board and handling. If any questions rose at using Hitachi products, please feel free to contact closest Hitachi representatives or offices.

2. MOS IC MEMORY

2.1 Prevention of static electricity

Similar to bipolar IC memories, suitable preventive measures should be taken for MOS IC memories by referring to paragraph 1.1.

2.2 Absorption of power source noise

The source current level flowing in the dynamic memory during the time of access is considerably different from that of stand by. Although the current difference is quite effective to save the power consumption, the current spike may be developed into the power source noise. Since all MOS IC memories are, in general, accessed while being refreshed, it is recommended to insert large capacitors (a 10 μ F capacitor for every 9 pieces of 16K-bit HM4716A, for example) as well as a 0.1 μ F capacitor having good high-frequency characteristics for each memory. Needless to say, it is very important to reduce the power circuit impedance when designing.

2.3 Current spike in V_{BB} power

The V_{BB} power is necessary for maintaining the IC memory function in the reverse bias and the current does not generally exceed the level of the reverse leakage current. However, in order to prevent an accidental current spike which is sharply formed in either positive or negative phase by the rise or fall clock pulse at the time of access, use a 0.1 μ F capacitor for every 2 or 3 memories for absorbing such noises.

2.4 Clock drive ICs

The TTL to MOS clock drive ICs have special designs so that they are capable of quick increase in the capacitive load. If a ground wire short-circuits either V_{DD} or V_{CC} which appear in the Pin No. 1 and No. 16 respectively, when the device is at high level, the device may be broken down. Carefully eliminate such possibility beforehand.

2.5 Power application sequence

It is advisable to design the circuits so that power is applied in the sequence of V_{BB} , V_{DD} and V_{CC} and interrupted in the reverse sequence, here the reverse bias V_{BB} is applied first and interrupted last.

It may be impossible for some small-scaled systems to apply power in the above-mentioned sequence (for example, when the V_{BB} is supplied by a DC to DC converter). According to our experiments conducted in the under-mentioned test conditions, it

has been proved that such a small-scaled system as to consist of 200 to 300 memory devices is not affected by the power application sequence.

Power application sequence test for N MOS IC

1.) Test method

- (1) Ambient temperature: 25°C
- (2) Power voltage: $V_{DD}=13.2V, V_{CC}=5.0V, V_{IH}=5.0V$
- (3) Operation mode: AC operation ("0" to "16383" all bits scanning).
 $t_{cyc}=10 \mu s$
 Read modify write operation
- (4) V_{BB} power: ON (1 min.) – Floating (1 min.)

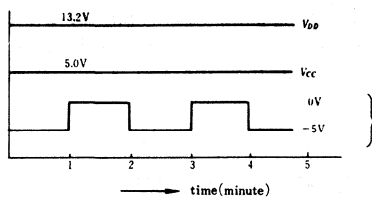

2.) Test results

Type No.	Number of cycles	Number of sample	Number of failures
HM4716A	2000 cycles	50	0

2.6 Assessment of the memory system design

It is quite effective to obtain the power margin curves (shmoo curve) for evaluating the memory system designs (timing margin or adaptability to the peripheral circuits). Investigate the V_{BB} and V_{DD} power behaviors by gradually varying their levels, and the ones which are closer to the margin shown by the memory device itself can be judged to be better than others.

2.7 Overhead parity bit

Application of MOS IC static memory especially to microcomputers has been rapidly increasing due to the advantages that MOS static memory is operated by a single 5V power source and refreshing is not required.

There are some cases where all bits are used as the information bit without inclusion of any parity bit by some circuit designing reasons. It is, however, desirable to add parity bits to thoroughly avoid the memory error.

1. VIEWS ON QUALITY AND RELIABILITY

Basic views on quality in Hitachi are to meet individual users' purchase purpose and quality required, and to be at the satisfied quality level considering general marketability. Quality required by users is specifically clear if the contract specification is provided. If not, quality required is not always definite. In both cases, efforts are made to assure the reliability so that semiconductor devices delivered can perform their ability in actual operating circumstances. To realize the quality in manufacturing process, the key points should be to establish quality control system in the process and to enhance morale for quality. In addition, quality required by users on semiconductor devices are going toward higher level as performance of electronic system in the market is going toward higher one and is expanding size and application fields. To cover the situation, actual bases Hitachi is performing is as follows;

- (1) Build the reliability in design at the stage of new product development.
- (2) Build the quality at the sources of manufacturing process.
- (3) Execute harder the inspection and reliability confirmation of final products.
- (4) Make quality level higher with field data feed back.
- (5) Cooperate with research laboratories for higher quality and reliability.

With the views and methods mentioned above, utmost efforts are made for users' requirements.

2. RELIABILITY DESIGN OF SEMICONDUCTOR DEVICES

2.1 Reliability Targets

Reliability target is the important factor in manufacture and sales as well as performance and price.

It is not practical to rate reliability target with failure rate at the certain common test condition. The reliability target is determined corresponding to character of equipments taking design, manufacture, inner process quality control, screening and test method, etc. into consideration, and considering operating circumstances of equipments the semiconductor device used in, reliability target of system, derating applied in design, operating condition, maintenance, etc.

2.2 Reliability Design

To achieve the reliability required based on reliability targets, timely study and execution of design standardization, device design (include process

design, structure design), design review, reliability test are essential.

(1) Design Standardization

Establishment of design rule, and standardization of parts, material and process are necessary. As for design rule, critical items on quality and reliability are always studied at circuit design, device design, layout design, etc. Therefore, as long as standardized process, material, etc. are used, reliability risk is extremely small even in new development devices only except for in the case special requirements in function needed.

(2) Device Design

It is important for device design to consider total balance of process design, structure design, circuit and layout design. Especially in the case new process and new material are employed, technical study is deeply executed prior to device development.

(3) Reliability Evaluation by Test Site

Test site is sometimes called Test Pattern. It is useful method for design and process reliability evaluation of IC and LSI which have complicated functions.

1. Purposes of Test Site are as follows;

- Making clear about fundamental failure mode
- Analysis of relation between failure mode and manufacturing process condition
- Search for failure mechanism analysis
- Establishment of QC point in manufacturing

2 Effectiveness of evaluation by Test Site are as follows;

- Common fundamental failure mode and failure mechanism in devices can be evaluated.
- Factors dominating failure mode can be picked up, and comparison can be made with process having been experienced in field.
- Able to analyze relation between failure causes and manufacturing factors.
- Easy to run tests.

etc.

2.3 Design Review

Design review is organized method to confirm that design satisfies the performance required including users' and design work follows the specified ways, and whether or not technical improved items accumulated in test data of individual major fields and field data are effectively built in. In addition, from the standpoint of enhancement of competition power of products, the major purpose of design review is to insure quality and reliability of the products. In Hitachi, design review is performed from the planning stage for new products and even

for design changed products. Items discussed and determined at design review are as follows;

- (1) Description of the products based on specified design documents.
- (2) From the standpoint of specialty of individual participants, design documents are studied, and if unclear matter is found, sub program of calculation, experiments, investigation, etc. will be carried out.
- (3) Determine contents of reliability and methods, etc. based on design document and drawing.
- (4) Check process ability of manufacturing line to achieve design goal.
- (5) Discussion about preparation for production.
- (6) Planning and execution of sub-programs for design change proposed by individual specialist, and for tests, experiments and calculation to confirm the design change.
- (7) Reference of past failure experiences with similar devices, confirmation of method to prevent them, and planning and execution of test program for confirmation of them. These study and decision are made using check lists made individually depending on the objects.

3. QUALITY ASSURANCE SYSTEM OF SEMICONDUCTOR DEVICES

3.1 Activity of Quality Assurance

General views of overall quality assurance in Hitachi are as follows;

- (1) Problems in individual process should be solved in the process. Therefore, at final product stage, the potential failure factors have been already removed.
- (2) Feedback of information should be made to insure satisfied level of process ability.
- (3) To assure reliability required as an result of the things mentioned above is the purpose of quality assurance.

The followings are regarding device design, quality approval at mass production, inner process quality control, product inspection and reliability tests.

3.2 Quality Approval

To insure quality and reliability required, quality approval is carried out at trial production stage of device design and mass production stage based on reliability design described at section 2.

The views on quality approval are as follows;

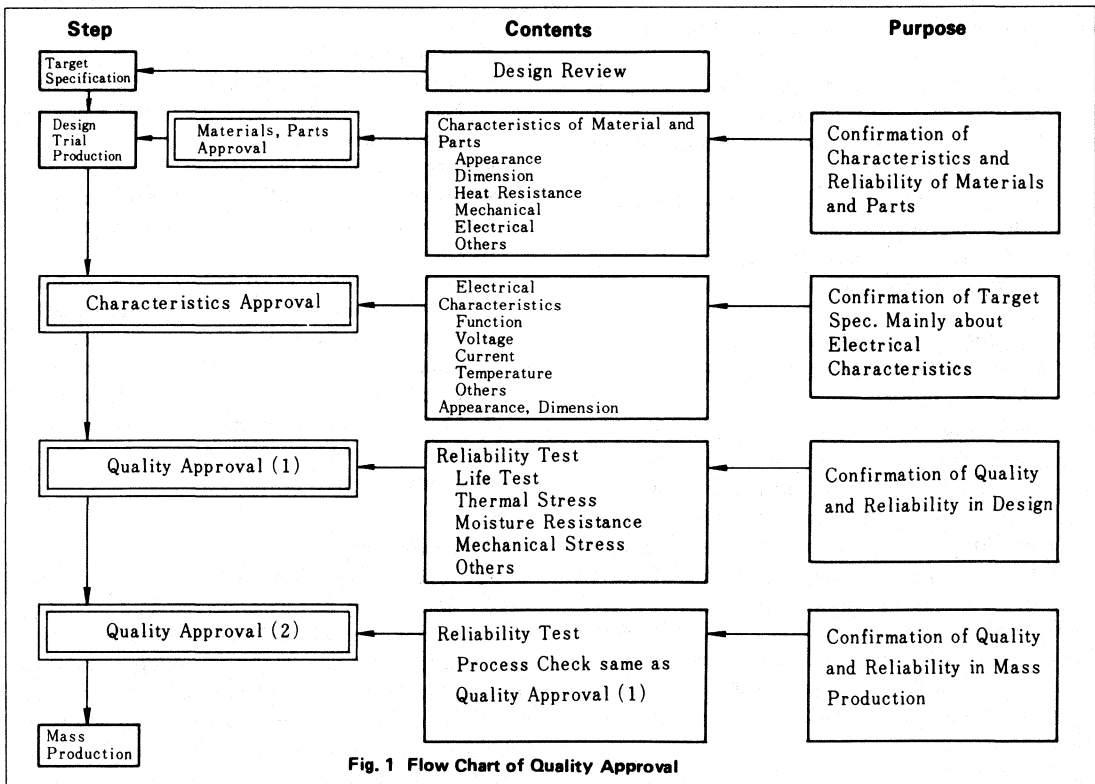

Fig. 1 Flow Chart of Quality Approval

- (1) The third party executes approval objectively from the stand point of customers.
- (2) Fully consider past failure experiences and information from field.
- (3) Approval is needed for design change and work change.
- (4) Intensive approval is executed on parts material and process.
- (5) Study process ability and fluctuation factor, and set up control points at mass production.

Considering the views mentioned above, quality approval shown in Fig. 1 is executed.

3.3 Quality and Reliability Control at Mass Production

For quality assurance of products in mass production, quality control is executed with organic division of functions in manufacturing department, quality assurance department, which are major, and other departments related. The total function flow is shown in Fig. 2. The main points are described below.

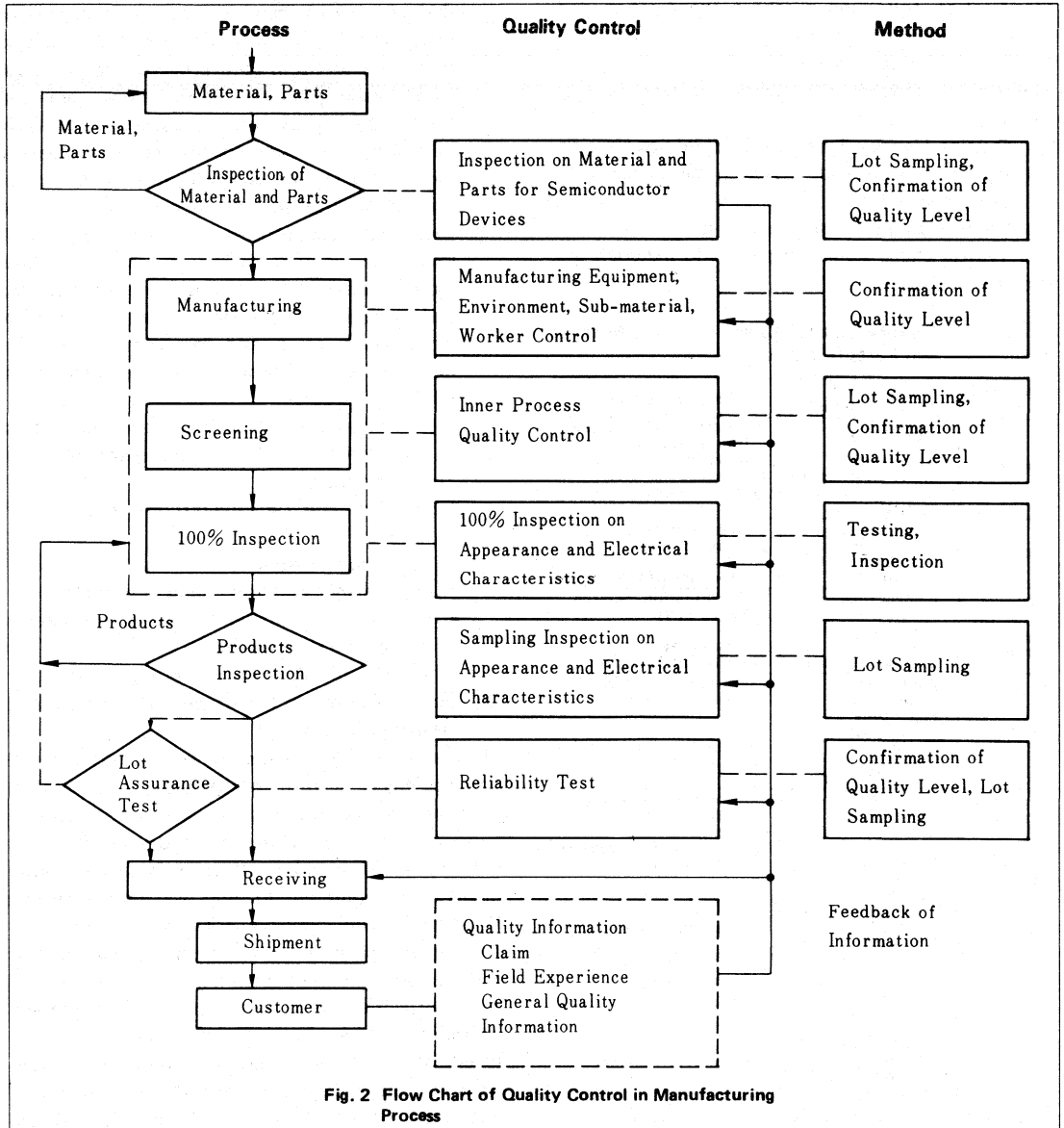

Fig. 2 Flow Chart of Quality Control in Manufacturing Process

3.3.1 Quality Control of Parts and Material

As tendency toward higher performance and higher reliability of semiconductor devices, is going, importance is increasing in quality control of material and parts, which are crystal, lead frame, fine wire for wire bonding, package, to build products, and materials needed in manufacturing process, which are mask pattern and chemicals. Besides quality approval on parts and materials stated in section 3.2, the incoming inspection is, also, key in quality control of parts and materials. The incoming inspection is performed based on incoming inspection specification following purchase specification and drawing, and sampling inspection is executed based on MIL-STD-105D mainly.

The other activities of quality assurance are as follows;

- (1) Outside Vendor Technical Information Meeting
- (2) Approval on outside vendors, and guidance of outside vendors
- (3) Physical chemical analysis and test

The typical check points of parts and materials are shown in Table 1.

● Table 1 Quality Control Check Points of Material and Parts (Example)

Material, Parts	Important Control Items	Point for Check
Wafer	Appearance	Damage and Contamination on Surface
	Dimension Sheet Resistance Defect Density Crystal Axis	Flatness Resistance Defect Numbers
Mask	Appearance	Defect Numbers, Scratch
	Dimension Restoration Gradation	Dimension Level Uniformity of Gradation
Fine Wire for Wire Bonding	Appearance	Contamination, Scratch, Bend, Twist
	Dimension Purity Elongation Ratio	Purity Level Mechanical Strength
Frame	Appearance	Contamination, Scratch
	Dimension Processing Accuracy Plating Mounting Characteristics	Dimension Level Bondability, Solderability Heat Resistance
Ceramic Package	Appearance	Contamination, Scratch
	Dimension Leak Resistance Plating Mounting Characteristics Electrical Characteristics Mechanical Strength	Dimension Level Airtightness Bondability, Solderability Heat Resistance Mechanical Strength
Plastic	Composition	Characteristics of Plastic Material
	Electrical Characteristics Thermal Characteristics Molding Performance Mounting Characteristics	Molding Performance Mounting Characteristics

3.3.2 Inner Process Quality Control

Inner process quality control is performing very important function in quality assurance of semiconductor devices. The following is description about control of semi-final products, final products, manufacturing facilities, measuring equipments, circumstances and sub materials. The manufacturing inner process quality control is shown in Fig. 3 corresponding to the manufacturing process.

(1) Quality Control of Semi-final Products and Final Products

Potential failure factors of semiconductor devices should be removed preventively in manufacturing process. To achieve it, check points are set-up in each process, and products which have potential failure factor are not transfer to the next process. Especially, for high reliability semiconductor devices, manufacturing line is rigidly selected, and tighter inner process quality control is executed – rigid check in each process and each lot, 100% inspection pointed process to remove failure factor caused by manufacturing fluctuation, and execution of screening needed, such as high temperature aging and temperature cycling. Contents of inner process quality control are as follows;

- Condition control on individual equipments and workers, and sampling check of semi-final products.
 - Proposal and carrying-out improvement of work
 - Education of workers
 - Maintenance and improvement of yield
 - Picking-up of quality problems, and execution of countermeasures
 - Transfer of information about quality
- #### (2) Quality Control of Manufacturing Facilities and Measuring Equipment

Manufacturing equipments are extraordinary developing as higher performance devices are needed and improvement of production, and are important factors to determine quality and reliability. In Hitachi, automatization of manufacturing equipments are promoted to improve manufacturing fluctuation, and controls are made to maintain prompt operation of high performance equipments and perform the proper function. As for maintenance inspection for quality control, there are daily inspection which is performed daily based on specification related, and periodical inspection which is performed periodically. At the inspection, inspection points listed in the specification are

checked one by one not to make any omission. As for adjustment and maintenance of measuring equipments, maintenance number, specification are checked one by one to maintain and improve quality.

(3) Quality Control of Manufacturing Circumstances and Sub-materials

Quality and reliability of semiconductor device is highly affected by manufacturing process. Therefore, the controls of manufacturing circumstances — temperature, humidity, dust — and the control of

submaterials — gas, pure water — used in manufacturing process are intensively executed. Dust control is described in more detail below.

Dust control is essential to realize higher integration and higher reliability of devices. In Hitachi, maintenance and improvement of cleanness in manufacturing site are executed with paying intensive attention on buildings, facilities, air-conditioning systems, materials delivered-in, clothes, work, etc., and periodical inspection on floating dust in room, falling dusts and dirtiness of floor.

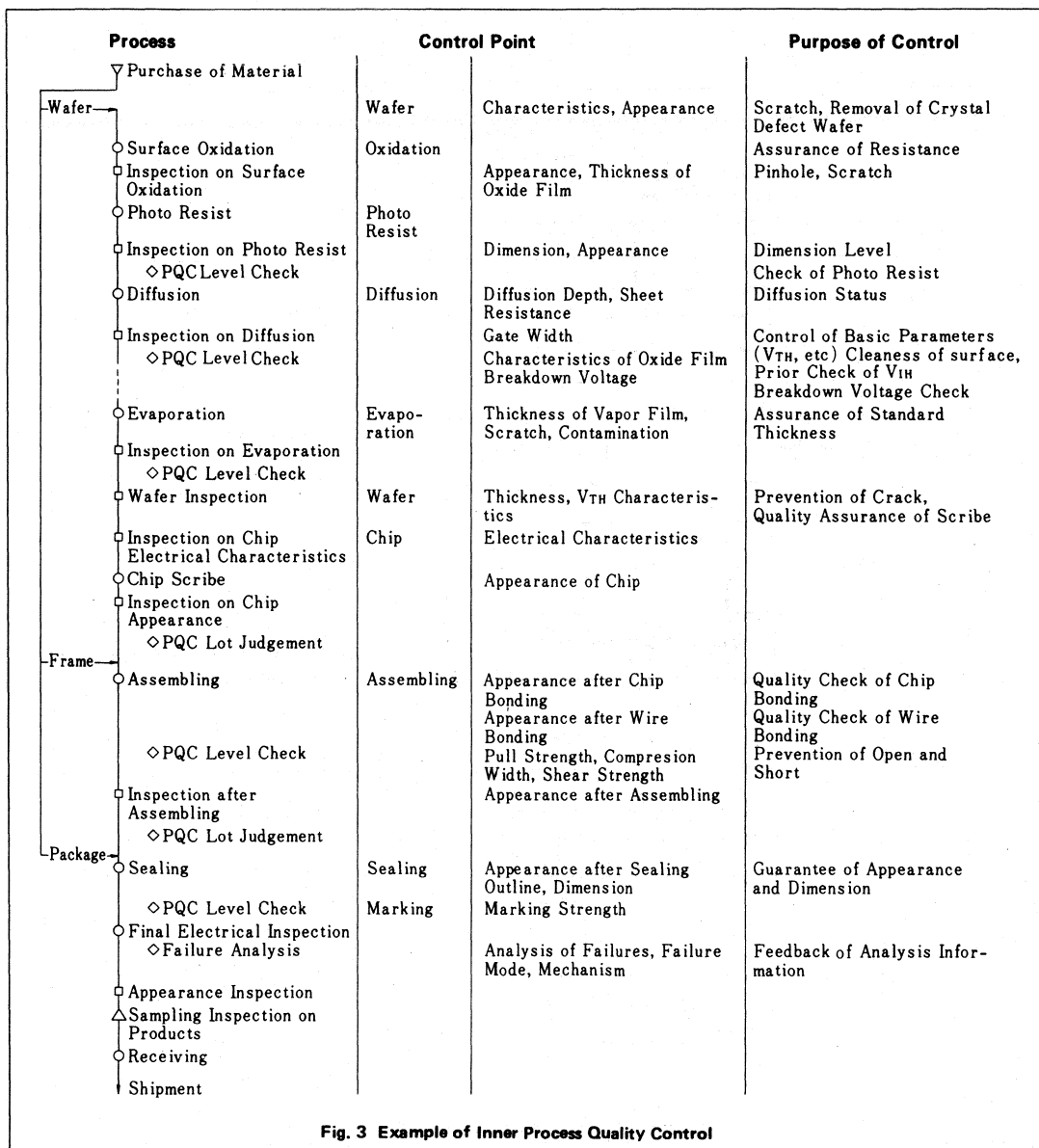

Fig. 3 Example of Inner Process Quality Control

3.3.3 Final Product Inspection and Reliability Assurance

(1) Final Product Inspection

Lot inspection is done by quality assurance department for products which were judged as good products in 100% test, which is final process in manufacturing department. Though 100% of good products is expected, sampling inspection is executed to prevent mixture of failed products by

mistake of work, etc. The inspection is executed not only to confirm that the products meet users' requirement, but to consider potential factors. Lot inspection is executed based on MIL-STD-105D.

(2) Reliability Assurance Tests

To assure reliability of semiconductor devices, periodical reliability tests and reliability tests on individual manufacturing lot required by user are performed.

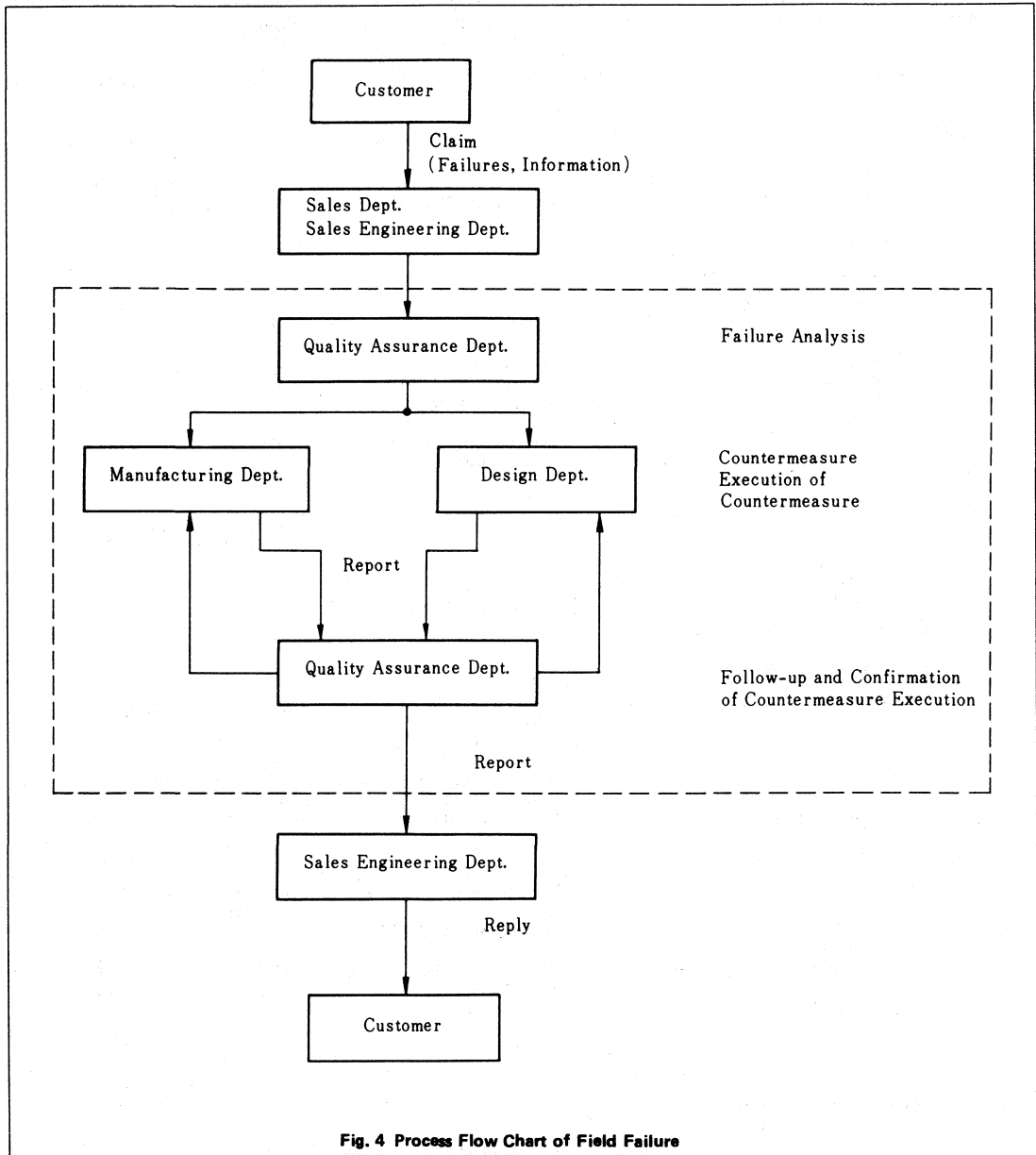

Fig. 4 Process Flow Chart of Field Failure

1. Inspection Method

Compared to conventional core memories, all peripheral circuits such as the decoder circuit, write circuit, read circuit, etc., are contained within the IC memories. As a result, all works of assembling the parts and performing electrical inspection, which had been carried out by core memory manufacturers in the past, have become to be incorporated as works of IC manufacturers. Consequently, the electrical inspection of the memory IC has been faced to a more systematic inspection method and conventional IC inspection facilities have become completely useless. This has led to the development and introduction of a memory tester with pattern generator to generate the inspection pattern of the memory IC at high speed. A function test for such as TTL gates can be performed even by a comparatively simple DC parameter facility. However, when the address input becomes multiplexed as in 16K memory, even the generation of the function test pattern becomes a serious problem. In the memory IC inspection, its quality cannot be judged by only inspecting DC characteristics related to external pins. This is because numbers of transistors, etc., related to the DC characteristics of the pins only amount to 1/1000 of all element numbers within IC memories. The following various address patterns are proposed to inspect whether or not the internal circuits are functioning correctly.

- (1) All "Low", all "High"
- (2) Checker flag
- (3) Stripe pattern
- (4) Marching
- (5) Galloping
- (6) Walking
- (7) Ping-pong

Although there are a lot of address patterns, only representative ones have been listed. These patterns are convenient for checking the mutual interference of bits and sometimes are patterns with maximum power dissipation. Among the above-mentioned patterns, those of (1) to (4) are the so-called N patterns and these patterns are capable of checking IC memories of N bits with several sequences of N at most against the memory IC of N bits. Whereas, those of (5) to (7) are called N² patterns and they need patterns several sequences of N².

A serious problem arises in using the N² patterns in a large-capacity memory, for example, a long period of about 30 minutes becomes necessary to perform inspection of the 16K memory with galloping

pattern. Patterns from (1) (3) are comparatively simple and good methods, but they are not perfect against a failure in the decoder circuit. As the most simple pattern for inspecting the necessary memory function, there is a "Marching" pattern.

2. Marching Pattern

The marching pattern, as its name indicates, is a pattern in which "1"s march into all bits written in "0"s. The addressing method will be explained for a simple 16 bit memory as an example.

- (1) Write "0" for all bits Fig. 1(a)
- (2) Read "0" of 0th address and check that the read data is "0". Hereafter, the meaning of "Read" is "checking and judging the data".
- (3) Write "1" in the 0th address Fig. 1(b)
- (4) Read "0" of 1st address
- (5) Write "1" in 1st address
- (6) Read "0" of nth address
- (7) Write "1" in nth address Fig. 1(c)
- (8) Repeat above procedures (6) and (7) up to the last. Finally, all data will become "1".
- (9) Since all data are "1"s in this condition, replace "0" and "1" after procedure (2) and repeat once more up to procedure (8).

It is understood that 5N address patterns are necessary for the N bit memory in this method.

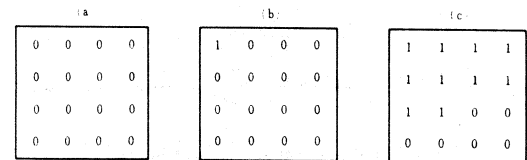

Fig. 1 Addressing method for 16 bits memory in the Marching pattern

3. Generation of Marching Pattern

The method of generating the marching pattern and displaying failed bits of the memory on the Braun tube will be introduced. Fig. 2 shows the all block diagram. The address pattern is generated by using four synchronous 4 bit counters. All address patterns are shown in Fig. 4. This example, is for 16K bit memory, however, it can be easily understood that A14 which has a half frequency of the maximum address input A13 is the same as the data input.

The A15 signal together with the carrier signal of HD74161 is used to determine the termination of the sequence.

As shown in Fig 2. In the read and write cycles after cleaning all bits addressing is twice the period of clearing. This switching is performed at the gate of

the binary circuit following the reference pulse generating circuit.

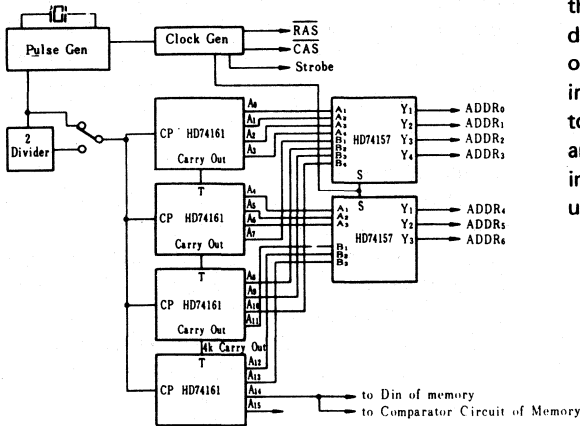

Fig. 2 Marching Pattern Generating Circuit

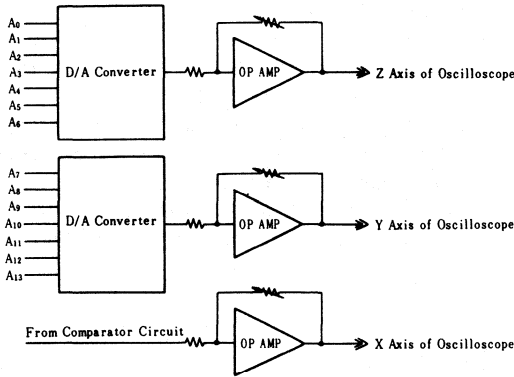

Fig. 3 Fail Bit Map Display Circuit

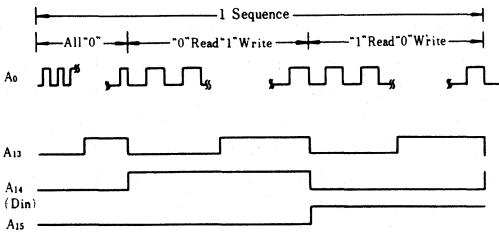
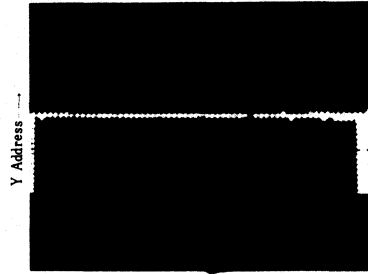

Fig. 4 Entire Pulse Relations

Input the output of HD74161 is input to the D/A converter and the output of D/A converter is connected to the oscilloscope to display → X-Y matrix. The output of the comparator circuit is connected to the Z axis and performs luminous intensity modulation. In this way, the fail bit map can be displayed on the CRT. Fig. 5 shows an example checking a voltage margin. By changing the

power voltage V_{BB} , the increase and decrease of the failed bits can be well understood. The operation of the memory can be dynamically understood by displaying its operation on the CRT. The operation of the memory IC is extremely complicated differing from other TTLs, etc.. Its operation is not easy to understand by pulse waveform observation with an ordinary oscilloscope. The fail bit map as shown in Fig. 5 is extremely useful. It is capable of visually understanding the operation of memory IC.



(a) $V_{BB} = -0.3V$ X Address

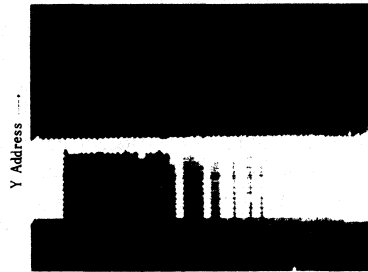

(b) $V_{BB} = -0.1V$ X Address

Fig. 5 Example of Dependency of Fail Bit Map on V_{BB}

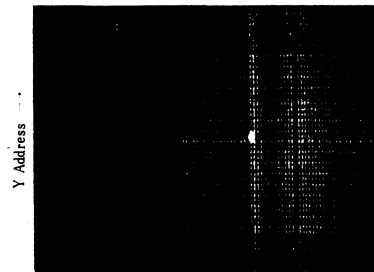

Fig. 6 Example of 1 bit solid fail

4. Failure Mode

Generally, failure 70% ~ 90% of failures at users are of those called solid failure. This failure mode has no relation with access time, voltage margin and timing, and is not capable of reading from or writing to certain specified bits and is failure fixed to "0"

or "1". An example of single bit solid failure is shown in Fig. 6. The convenient checker, previously mentioned as simple tester, is sufficiently capable of detecting such failures. Therefore, with the exception of special cases, it can be considered that the necessity of performing high-precision measurements such as those made by memory IC manufacturers is rare.

In the inspection of memory IC at our company, full inspection under the worst conditions are performed so as to guarantee sufficient operations under all power voltage conditions and timing conditions listed in the data sheet.

An extremely accurate memory tester becomes necessary for performing high-precision inspection with 1ns accuracy. Our company is developing IC memory testers to supply memory ICs with excellent characteristics and quality to users and is establishing the system capable of developing further high-efficiency memory ICs.

APPLICATION OF DYNAMIC RAMS

1. Power On

After turning on power to set the memory circuitry, hold for more than 500 μ s and apply eight or more dummy loads before actuating the memory. The dynamic cycle may be either an ordinary memory cycle or a refresh cycle. When power is turned on, power-on current flows which varies with the rise time of V_{CC} and clock conditions, as shown in Fig. 1. If the rise time is 10 μ s or thereabout, the RAM does not operate dynamically and through-current passes to the internal inverter since the potential at the internal circuitry becomes unstable. Nevertheless, this through-current decreases as the operation of the internal circuitry becomes stable. With all this in mind, rise time of not shorter than 100 μ s is recommended for power-up.

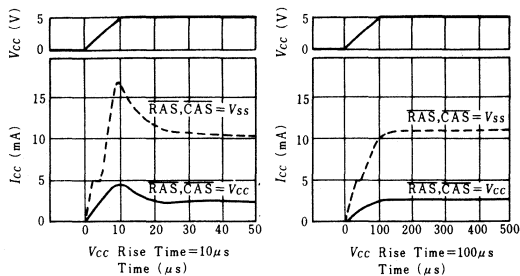

Fig. 1 Relationship between standard value of I_{cc} and V_{cc} during power-up

2. Operation Modes (See Fig. 2)

(1) Read Cycle:

First, decide the X address of the memory cell chosen and start with trailing of \overline{RAS} . When the X address has been held by the internal circuitry, change it to Y address. Then, trail \overline{CAS} to take in the Y address. If the \overline{WE} pin is at high level, output will appear on the Dout pin after a certain time.

(2) Write Cycle:

The input at Din is written in the memory cell when \overline{WE} turns to low level before \overline{CAS} .

(3) Read/Modify/Write Cycle:

During this cycle, \overline{CAS} and, then, \overline{WE} are trailed down to low level so that data is read out from and written in the same address with in the same memory cycle.

(4) Page Mode Cycle:

In this cycle, \overline{CAS} is cyclically moved, after taking in the X address through \overline{RAS} , to scan only the Y address. This permits reading out and writing in only one column data at high speed.

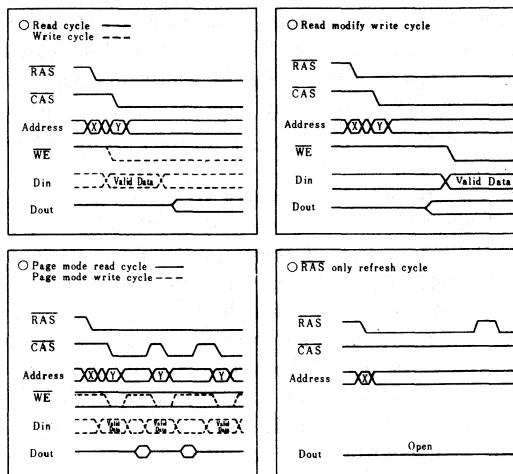

Fig. 2 Operating modes of Dynamic RAMs

2. Data Output

Dout is a TTL-compatible three-state output with two TTL-load fan outs. The output is controlled by the \overline{CAS} signals; it is held while \overline{CAS} is low, while Dout returns to a floating state when \overline{CAS} is high. In the early write cycle, the output becomes a high-impedance one to permit the use as a common I/O terminal.

3. Refreshing

Refreshing is a process of periodical rewriting to make up for the leakage of the charge accumulated in the memory cell. This operation is implemented in the \overline{RAS} only refresh cycle, ordinary read cycle, and so on. Whether 16k- or 64k-bit, all bits can be refreshed by giving a 128-cycle scanning to only the X addresses between A0 and A6. To be more specific, each cycle refreshes 128 bits for the 16k-bit Dynamic RAMs and 512 bits for the 64k-bit RAMs. Especially, the \overline{RAS} only refresh cycle permits such a power-efficient refresh as calls for only approximately 75 percent of the current consumed by the read cycle. With \overline{CAS} fixed at high level, the output is a high-impedance one. The HM4816A has a special function called the hidden refresh which enables holding the output by turning \overline{CAS} to "low" while \overline{RAS} only refresh is on. There are two methods of refreshing: concentrated and deconcentrated refreshing. The former gives a concentrated 128-cycle refresh after operating the memory for a period of 2ms maximum. In contrast, the latter repeats a refreshing cycle every 16 μ s following the initial 16 μ s (=2ms/128) memory operation. A

choice between the two modes calls for a careful consideration about the system's efficiency.

4. Operating Current for Dynamic RAMs

Fig. 3 shows the waveforms of the current applied in various operating modes (HM4864). The mean operating current in each mode equals the value obtained by dividing the integrated result of each waveform by the cycle time. The first peak current in each operating mode appears as a result of the circuit operation during the memory access time. On the other hand, the peak current during standby appear as a result of the precharging operation in each circuit. Having two circuitry operation modes — X and Y. Dynamic RAMs show different peak currents depending upon the operating timing of RAS and CAS. That is, the greatest peak current appears when both X and Y circuits operate simultaneously. The maximum peak current for the HM4864, for example, is approximately 100mA. The current consumed while the memory stands by on the board is expressed in terms of the cycle time dependency shown in Fig. 4. During standby, with a once-in-every 16 μ s refresh, the HM4864 consumes approximately 3mA of current.

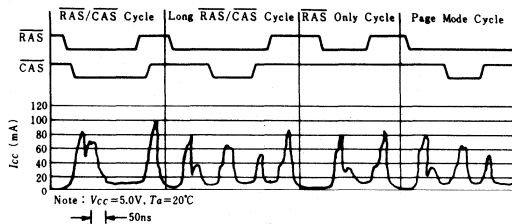

Fig. 3 Power supply voltage (HM4864)

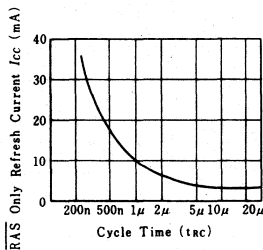

Fig. 4 Cycle time dependence of $\overline{\text{RAS}}$ only refresh current (HM4864)

5. Noise

Broadly, noise can be classified into power source noise and input signal noise. With the latter, furthermore, whether it is an overshoot or undershoot must be considered. The overshoot should be

held below the highest input level specified. As to the undershoot, the input-undershoot-induced parasitic transistor effect in the input area is prevented by providing a $-5V V_{BB}$ to the three-way power source and a built-in bias circuit on the substrate. Normally, design should be such that the input undershoot does not exceed the minimum value specified for V_{IL} , at worst. The power source noise can be further classed into low-frequency noise and high-frequency noise as shown in Fig. 5. To assure a stable memory operation, the peak-to-peak power supply voltage in the presence of low- or high-frequency noise should be held below 10 percent of its standard level. Overshoot and undershoot can be reduced by inserting a damping resistance of several tens of ohms in Dynamic RAM series. To prevent the power source noise, it is recommended to provide a condenser of 0.1 μ F or so to each one or two devices.

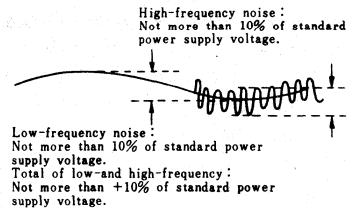

Fig. 5 Power source noise

PROGRAMMING & ERASING OF PROMS

1. PROGRAMMING & ERASING OF EPROM

1.1 Programming

Information is programmed into the memory cell of an EPROM by applying a high voltage to its drain and gate (Fig. 1 and 2). The high voltage at the drain increases the energy of the electrons in the channel area. When the energy becomes high enough, the electrons become what are known as "hot electrons" that are capable of jumping across the oxide film. Pulled by the high voltage at the gate, the hot electrons are admitted into the floating gate. The electric charge entering the floating gate changes the threshold voltage in the memory element, whereby it is stored as new information. When reading out, voltage is applied as shown in Fig. 3, and "1" and "0" are identified by checking whether or not current flows. Since the drain voltage for read-out is set at about 3V, no erroneous writing takes place. When shipped, all bits of the EPROM are held at logic "1" with all electric charge released (with no information programmed in). By changing the logic 1 to logic 0 through the application of the specified waveform and voltage, the necessary information is programmed in. The higher the V_{pp} voltage and the longer the program pulse width t_{pw} , the more will be the quantity of electrons to be programmed in, as shown in Fig. 4. If the V_{pp} exceeds the rated value, such as by overshoot, the p-n junction of the memory may yield to permanent breakdown. To avoid this, check V_{pp} overshoot by the PROM programmer and take all other possible caution. Also with for the negative-voltage-induced noise at other terminals, since it can touch off a parasitic transistor effect and apparently reduce the yield voltage Hitachi's EPROMs are usually capable of being written and erased more than 100 times, although the number of times is not guaranteed because it is difficult to give an exhaustive inspection prior to shipment. At any rate, 100 times is enough since the frequency of reprogramming in practical application rarely exceeds about 10 times.

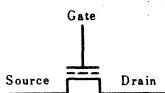

Fig. 1 Memory transistor circuit symbols

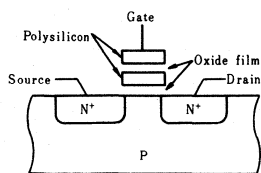

Fig. 2 Cross section of memory transistor

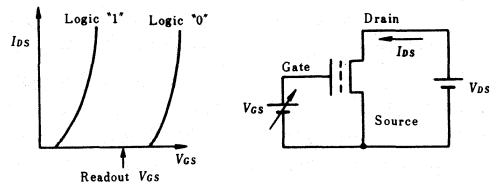

Fig. 3 Reading out stored information

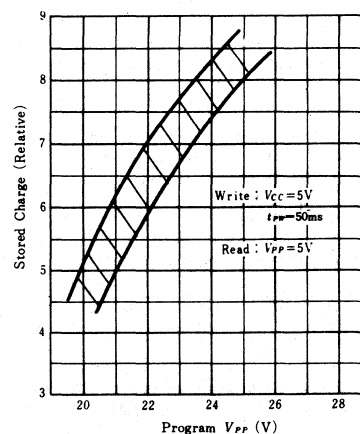
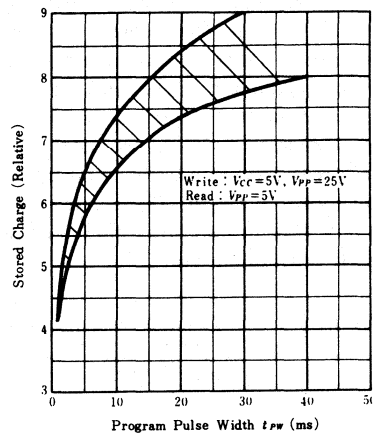

Fig. 4 Typical Programming Characteristics of EPROMs.

1.2 Erasing

Data stored in the EPROM is erased by releasing the electric charge from the floating gate through the exposure of the memory chip to ultraviolet light. Light has an energy that is inversely proportional to its wavelength. Receiving the energy of the ultraviolet light, the electrons in the floating gate are again turned into hot electrons, which jump across the oxide film into the control gate or substrate. As a result of this process, the stored information is erased. Accordingly, the stored information can not be erased by such lights whose wavelengths are too long to give adequate energy to jump over the barrier of the oxide film. For successful erasing, the wavelength and minimum exposure rate of ultraviolet light are specified as $2,537\text{\AA}$ and 15W sec/cm^2 respectively. This condition is attained by exposing a device to an ultraviolet lamp of $12,000\mu\text{W/cm}^2$ $1.2 \sim 3\text{cm}$ away for approximately 20 minutes. The ultraviolet light transmission rate of the transparent lid is about 70 percent. Any contamination or foreign material at the surface of the capsule lowers the transmission rate, prolonging the erasing time. So such contamination should be recovered by use of alcohol or other solvent that does not damage the package. Fig. 5 shows typical erasure characteristics for EPROM.

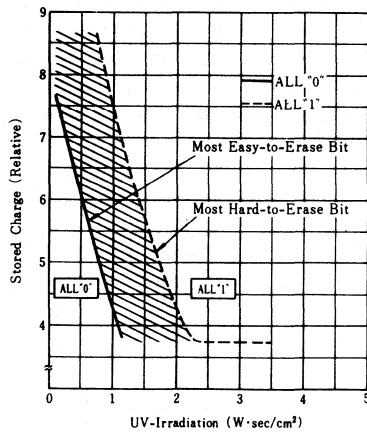

Fig. 5 Typical Erasing Characteristics

1.3 Data retention characteristic of EPROM

As a result of writing in, approximately 0.5 to 2.0×10^{-13} coulomb of electrons are accumulated at the floating gate. With the elapse of time, however, these electrons decrease, as a result of which the inversion of stored information can happen. The mechanism of electron dissipation is generally explained as follow:

(1) Data dissipation by heat

The accumulation of electrons at the floating gate is an unbalanced state, so the dissipation of thermally excited electron is unavoidable. Therefore, the data holding time has a close relationship with temperature. Fig. 6 shows typical data retention characteristics. The data retention time is proportional to the reciprocal of absolute temperature.

(2) Data dissipation by ultraviolet light

Ultraviolet rays at a wavelength of not greater than $3,000 \sim 4,000\text{\AA}$ is capable of releasing the electric charge stored in the memory of the EPROM with varying efficiencies. Fluorescent light and sunlight contain some ultraviolet rays, so prolonged exposure to these lights can cause data corruption as a result of electric charge dissipation. Fig. 7 shows examples of the data retention time under an ultraviolet eraser, sunlight and fluorescent lighting. But it should be noted that the data for fluorescent light and sunlight are not definite because of their-varying ultraviolet ray contents. The ultraviolet ray content in sunlight, for example, varies greatly with seasons, weather and the composition of the atmosphere.

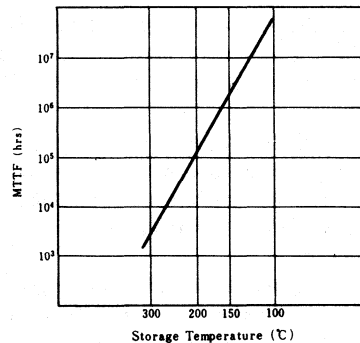

Fig. 6 Typical Data Retention Characteristics

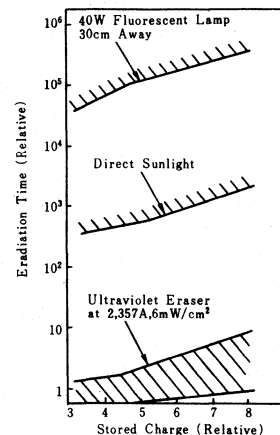

Fig. 7 EPROM's data retention time

(3) Data dissipation by voltage

This type of data dissipation occurs while information is being written in. At other memory cells lying on the same word line or data line as the memory cell being programmed, high voltage can cause the dissipation of stored electric charge. Of course, such defects are removed at the factory by pre-shipment inspection. The programming voltage and pulse width should be always kept within the specified range for the same reason.

1.4 EPROM Programmer

The 16K EPROM Programmer stores the program in its internal RAM and writes the program in the EPROM. For this programming, the minimum of 3 functions, the Blank check function prior to programming, the programming function and the Verify function after programming are necessary. As shown in the drawing, there are also programmers provided with a reverse insertion checking function or pin contact checking function prior to the Blank Check. The outline of each block is as follows.

(a) Pin contact check

In the connection test of the ROM pin and the socket, normally checking is performed by detecting the forward current of each EPROM pin. Care is necessary as this forward biased resistance differs according to products of each company.

(b) Reverse insertion check

This check detects the reverse insertion of the device, places the equipment in reset mode and protects the device and equipment.

(c) Blank check

This check is performed prior to programming and checks whether or not it is an erased EPROM or for preventing EPROM reprogramming. Since the output data in the erased condition are "1" (high level), check whether or not data in EPROM are all "1". It will fail-stop even when 1 bit of "0" (low level). Normally, it is designed to provide warning with a lamp or buzzer.

(d) Programming

The function of programming the data in the internal RAM of the programmer into EPROM and will fail-stop when programming cannot be made. The normal flow is as shown below. The EPROM data will be read out prior to programming and compared with programming data. If they coincide, programming will be skipped and if they differ, programming will be

performed. Then, read out will be made again and compared with the programming data, and if they coincide, it will progress to the next address.

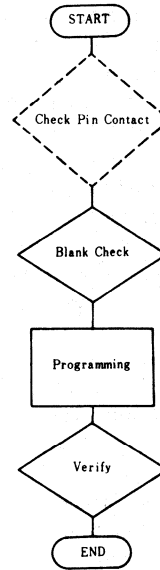

(e) Verify

This function is for checking after programming completion whether or not the programming is correct when comparing with the data in the internal RAM of the programmer and it performs fail-stop when it does not coincide. Normally, when it fails, together with lighting of the fail lamp, the address and data are displayed.

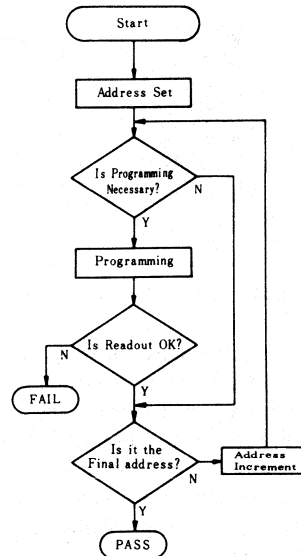

(f) How to input the program

There are the following methods for inputting the program data to the internal RAM of the programmer. Normally, paper tape input and retypewriter input are options.

Method	Content
Copy input	Input by copying the master ROM.
Manual input	Input by the keyswitch of the front panel. Used for correction or revision of program
Paper tape input	Read the paper tape furnished from the host system with the tape reader
Teletypewriter input	Input with the teletypewriter. Preparation, correction and list preparation of the program can be made.

1.5 Handling EPROM

When brought in contact with a charged human body or rubbed with plastics or dry cloth, the glass window of an EPROM generates static electricity which causes device malfunctions. Typical malfunctions are faulty blanking and write margin setting that give a wrong impression that information has been correctly written in. As already reported at the international conferences concerning the reliability of LSI chips, this is due to the prolonged retention of electric charge (resulting from the static electricity) on the glass window. Such malfunctions can be eliminated by neutralizing the charges through the irradiation of ultraviolet rays for a short time. It is recommended to execute reprogramming after this irradiation since it reduces the electric charges in the floating gate, too. The basic cluntermeasure is to prevent the charging of the window, which can be achieved by the following methods as in the prevention of common static breakdown of ICs.

- (1) Establish a ground for the operator to handle EPROM. Avoid the use of gloves etc. that may develop a static charge.
- (2) Refrain from rubbing the glass window with plastics and other substances that may develop a charge.
- (3) Avoid the use of coolant sprays which contain some ions.
- (4) Use shielding labels (especially those containing conductive substances) that can evenly distribute the established charge.

1.6 Shielding label

When using an EPROM in an environment where ultraviolet exposure can occur, it is advisable to put a shielding label on its glass window to absorb ultraviolet light. Specially prepared shielding labels are

marketed. Metal-loaded labels are particularly effective. In choosing a shielding label, the following points should be carefully checked.

(1) Adhesiveness (mechanical strength)

Avoid repeated attaching and dusting that may reduce the adhesive strength. Ultraviolet erasing and reprogramming are recommended after stripping off an attached label. (When the need arises to change a label, it is advisable to put a new one on the old one since peeling may develop a static charge.)

(2) Allowable temperature range

Use the shielding label in an environment whose temperature falls within the specified allowable temperature range. Beyond the specified temperature range, the paste on the label may harden or stick too fast. When it hardens, the label may come off easily. When it sticks too fast, the paste may remain on the window glass even after the label has been removed.

(3) Damp-proofness

Use the shielding label in an environment whose humidity falls within the specified allowable humidity range. Today there are few shielding labels that can meet all environmental requirements established for the EPROM. So a suitable one must be chosen for each specific application.

2. PROGRAMMING OF BIPOLAR PROMS

2.1 Programming System

The storing system of the Bipolar PROM can be generally classified into 2 systems; the Blown diode system and fuse system.

The latter is a system in which the metal-made fuse is burned off by current (Fig. 5). In the former, Emitter-Base junction is short-circuited by Al, which has penetrated into Base because of current

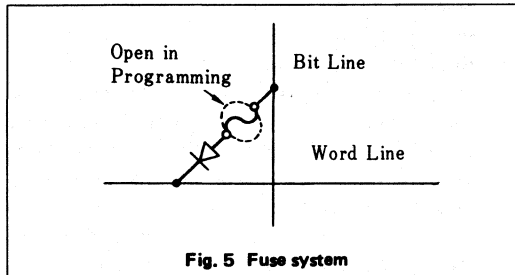

Fig. 5 Fuse system

pulse applied to E-B junction (Fig. 6). Generally, the blown diode type is considered to be more reliable. A grow back phenomenon, that is, migration and recombination of the metal, is seen in fuse system. HITACHI devices use the blown diode system.

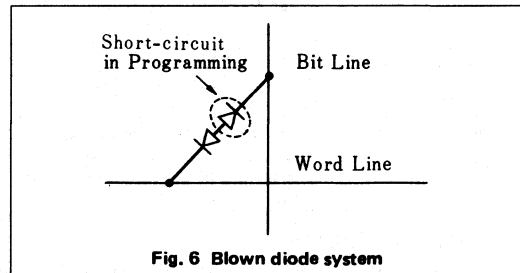

Fig. 6 Blown diode system

2.2 Programming Method

Programming is executed by the conventional programming equipment (PROM writer) using a board suited to the product.

First, check if all bits are programmable (Blank check), next write the pattern you want to program one by one bit. At every application of current pulse, confirm that program is available by sensing output level. And when programming has been completed, apply additional pulse. This process should be performed for all bits into which you want to write, and as you have completed programming, check (Verify) if you have programmed in the same pattern as you intended. If you do not find any mistake, programming has been completed.

For Blank check, Sense and Verify whether output pin level is high (non-programmed) or low (programmed) is checked by sense current (I_s). $V_s - I_s$ characteristic of normal series and S series is shown in Fig. 8 and 9, respectively. Specified value of sense current (I_s) of both normal series and S series is 20 mA, and voltage reference level is 7.5 V.

Fig. 10 and 11 show the relation between program current and program pulse number necessary for 1 bit to be written. With consideration of its influence on breakdown voltage, program current is specified as 130 mA in normal series and as 90 mA in S series.

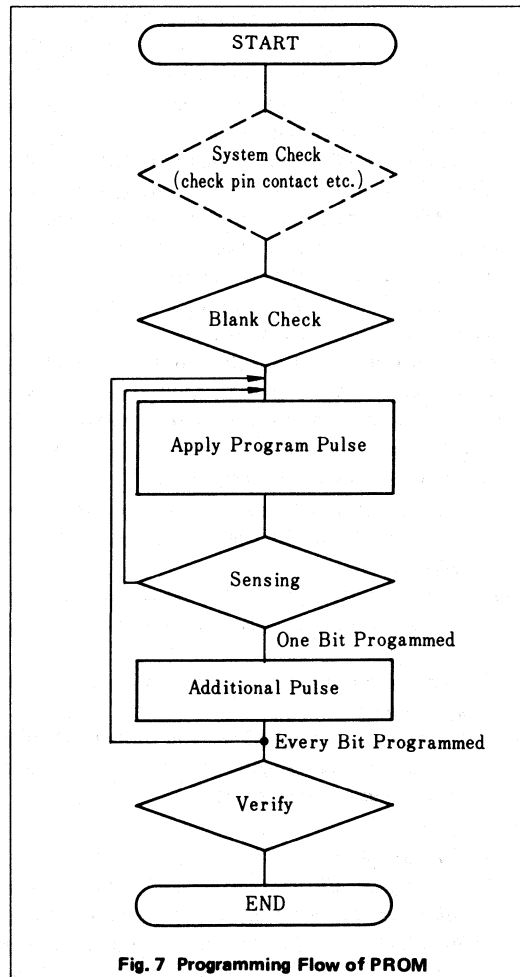

Fig. 7 Programming Flow of PROM

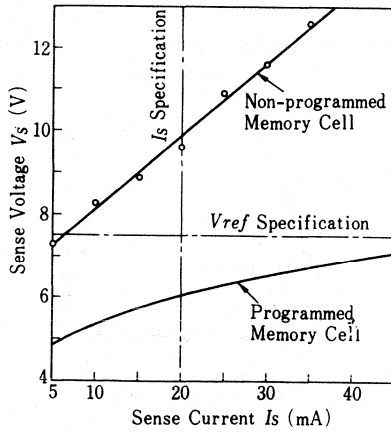

Fig. 8 $V_s - I_s$ Characteristic of Normal Series (HN25089)

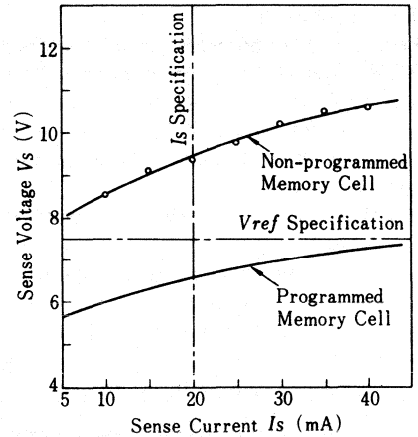

Fig. 9 $V_s - I_s$ Characteristic of S Series (HN25169S)

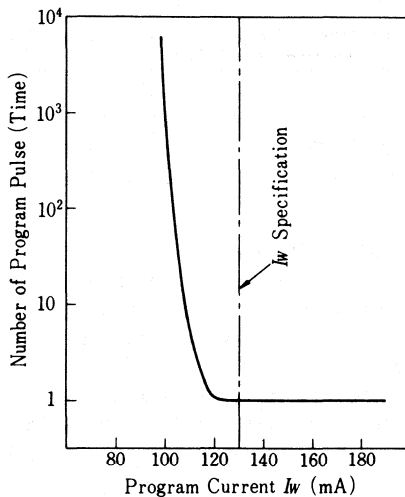

Fig. 10 Program Pulse - I_w Characteristic of Normal Series (HN25089)

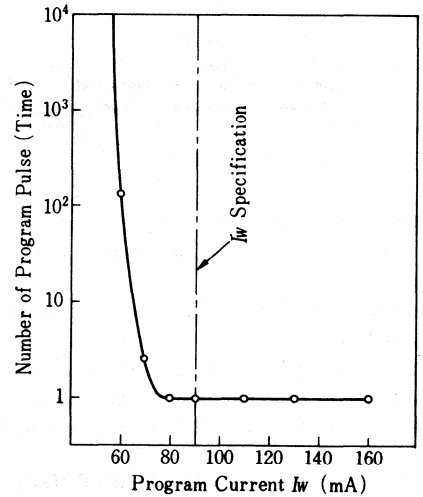

Fig. 11 Program Pulse - I_w Characteristic of S Series (HN25169S)

2.3 Programming Characteristics of Hitachi Bipolar PROM

- Small program current
130 mA for normal series, and 90 mA for S series are required for programming. Therefore, there are few bad effects caused by breakdown voltage degradation and parasitic effects.
- Fast programming speed
As seen in Fig. 10 and 11, program pulse for 1 bit memory cell can be mostly written at one time. Consequently, the program time per device is quite short. In case of 8K bit, for example, only 2 or 3 seconds at an average are required.
- High programming yield
Unlike the MOS PROM, the Bipolar PROM cannot be rewritten, once it is written into the memory

cell. Therefore, it does not allow programming and inspection of the product prior to delivery. Due to this, sometimes a defective product (which does not allow programming) might be delivered. Generally, the programming efficiency percentage is 90~95% when programming is performed on the user's side. Special tests such as actually performing programming on the dummy cell in the chip, performing continuity test of all memory cells, etc., are made prior to delivery for minimizing the possibility to deliver defective products.

2.4 Programming

There are two methods in the programming of PROM. That is, the method when programming is made by PROM manufacturer and delivered and the method when programming is made on the user's side. Both these methods and procedures will be explained below.

2.4.1 Programming performed by the PROM manufacturer

As shown in the drawing below, the manufacturer receives the program specification (specification designating the program pattern) from the user, performs writing (Programming) in accordance with the specification and performs delivery. In this case, a special writing fee is charged.

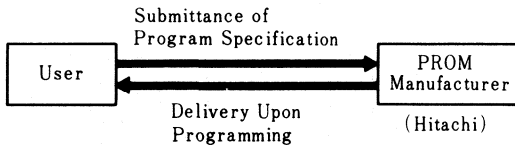

2.4.2 Programming performed by user

In this case, the following three items must be prepared by the user.

1 PROM WRITER (Main unit of programming equipment)

One capable of being used in common with equivalent products of other companies.

2 Performance board (Exclusive board designated by each manufacturer)

Minimum of 1 board for Hitachi PROM.

3 Sockets (sockets suited to product)

Minimum of one socket per product. These sockets are purchased from the PROM WRITER manufacturer.

The relationship among PROM WRITER manufacturer, Hitachi and user is shown in Fig. 12.

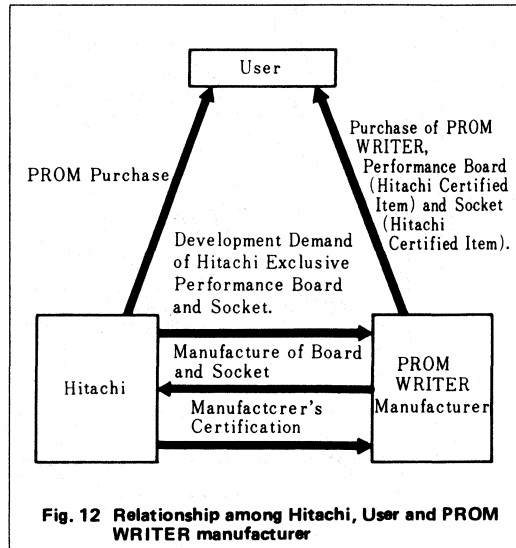

Fig. 12 Relationship among Hitachi, User and PROM WRITER manufacturer

As indicated above, the user purchases the performance board and sockets exclusively for Hitachi products together with purchasing the PROM WRITER.

2.5 Programming Device

There are about ten programming device manufacturers. However, this does not mean that any manufacturer's device will suffice. The reasons are as follows.

- It costs several hundreds of thousands or several million yen to have a programming device manufacturer develop a dedicated board for Hitachi and to qualify it.
- The suitability of the programming device affects the programming efficiency. Therefore, it should be a device of a reliable manufacturer.
- The servicing setup for handling troubles should be consolidated. The setup should be one that judgement can be accurately made on whether it is a writing device trouble or PROM trouble.

Hitachi has prepared a list of recommended manufacturers which meet the above requirements. Please contact our sales engineering staff for information in this regard.

MASK ROM PROGRAMMING INSTRUCTION

The writing of the custom program code into the mask ROM is performed by the CAD system using a large-sized computer. You should submit the data of the ROM code in conformity with the specification explained below by either paper tape, EPROM or magnetic tape. In addition, enter your instructions such as the chip select, customer part number, etc., in the "ROM Specification Identification Sheet" and attach it to the ROM code data.

1. Overall Specification

Since the submitted paper tape, card or magnetic

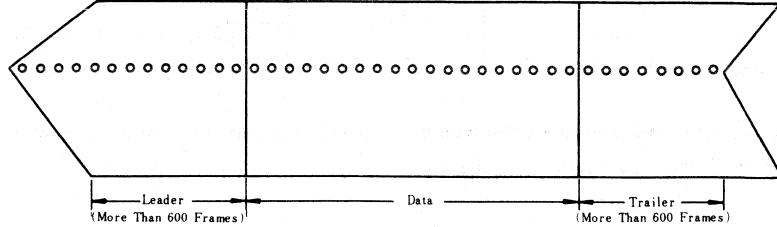

1.1.3 Parity mode

The presence and type of parity are clearly described in the "ROM Specification Identification Sheet".

There are following modes in the parity system.

- (1) With parity
 - Even parity EVEN
 - Odd parity ODD
- (2) Without parity

1.1.4 Use the 8 unit ASC11 code as the code.

1.2 Specification of Magnetic Tape

1.2.1 Use the following type of magnetic tape which can be netered in a magnetic tape device which is compatible with the IBM magnetic tape device.

- (1) Length 2,400 feet, 1,200 feet or 600 ffeet
- (2) Width 1/2 inch
- (3) Channel 9 channels
- (4) Bit density 800 BPI or 1,600BPI (Clearly state which it is in the "ROM Specification Identification Sheet".)

1.2.2 Use the EBCDIC code as the use code.

1.2.3 Make the format of the magnetic tape as described below.

- (1) No leading tape mark
- (2) No label

tape is fed into the large-size computer as it is, observe the following specifications.

1.1 Specification of Paper Tape

1.1.1 Any color paper tape may be used as long as it is a marketed 1 inch wide paper tape for computers. However, a black color paper tape is recommended.

1.1.2 Take more than 600 frames for the leader and trailer.

- (3) Record size 80 byte/1 record
- (4) Block size 10 records/1 block
- (5) The end of the file should be indicated by 2 successive tape marks (TM).

1.2.4 Ensure that the magnetic tape becomes of 1 roll for each chip. Since extending the single-chip portion over several rools is impermissible, submit by compiling into the single-chip portion for each roll.

2. Data Mode

2.1 HMCS6800 Load Module Mode

This mode is the object mode output from the assembler of HMCS6800.

2.1.1 Divide the 8 bit code into the upper and lower 4 bit codes and convert each into hexadecimal notation.

(Example) The code of 1100 0110 becomes as follows under binary notation.

(Upper 4 bits)	(Lower 4 bits)	Bit weight
D ₇ D ₆ D ₅ D ₄	D ₃ D ₂ D ₁ D ₀	(ROM output
1 1 0 0	0 1 1 0	equivalence)

2.1.2 The composition of the load module mode is shown below by taking the case of paper tape as the example. The numbers written in the tape are ASCII code hexadecimal numbers of the data.

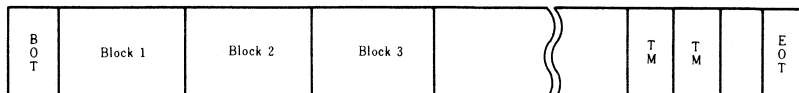

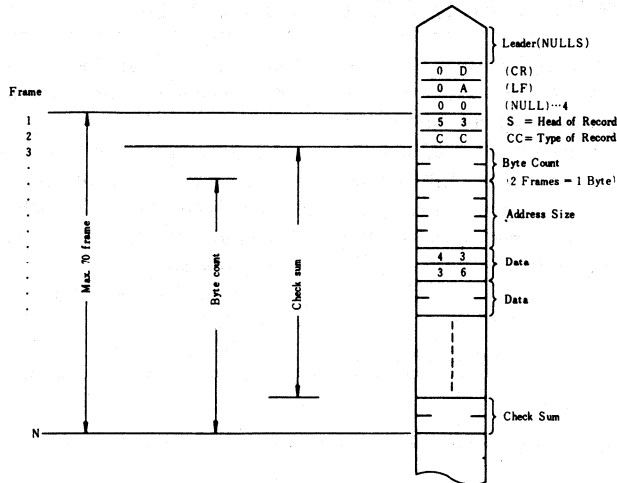

(Note) The check sum is a technique which disregards the complement on one of each bit sum of the 8 bits.

2.1.3 The actual load module mode becomes as shown below.

	CC=30	CC=31	CC=39
Frame	Header record	Data record	End of file record
1	Record Start 5 3 S	5 3 S	5 3 S
2	Record Type 3 0 0	3 1 1	3 9 9
3	Byte Count 3 0 0 6	3 1 1 6	3 0 0 3
4		3 6 1 6	3 3 0 3
5	3 0	3 1	3 0
6	3 0	3 1	3 0
7	Address Size 3 0 0000	3 0 1100	3 0 0000
8	3 0	3 0	3 0
9	Data 3 4 48-H	3 9 9 8	4 6 FC (Check Sum)
10	Data 3 4 44-D	3 8 0 2	4 3 3
	Data 3 5 52-R		
	3 2		
N	Check Sum 3 1 1B (Check Sum)	4 1 A8 (Check Sum)	
	4 2	3 8	

S0 indicates the head of the file and S9 indicates the end of the file. The actual data enters following S1. It means that the data starts from the address (hexadecimal) indicated in the address size. The address of the address size of the data recorder is compared with the next data recorder address by

counting in increments of 1 byte of the data and checking whether it is sequential or not. In places where the address is skipped, the data of 00 or FF enters hexadecimally. The printed example of the paper tape of the HMCS6800 load module mode is as shown below.

Example

Header Record	→ S00B000058204558414D504CB5
Data Record	→ S113F0007EF5587EF7897EFAA77EF9C07EF9C47E24
Data Record	→ S112F010FA657EFA8B7EFAA07EF9DC7EFA247E06
End of File Record	→ S9030000FC

2.1.4 The ROM code data are capable of handling the following 4 types of cases. A header recorder is required in front of the data recorder and an end of file recorder at the back of the data recorder.

(1) Case when the data reaches full capacity of ROM

The ROM recorder for 1 chip enters into the data recorder. Since the address of the address size of the data recorder counts the data and checks whether or not it is in a sequential address, it becomes necessary that the address not be skipped. The ROM head address column of the "ROM Specification Identification Sheet" becomes 0.

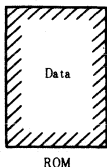

(2) Case when data is input from en route of ROM

In this case, perform entry by decimal notation in the ROM head address column of the "ROM Specification Identification Sheet" on which ROM address you wish to input the data. The data 00 or FF will enter into the blank address by hexadecimal notation.

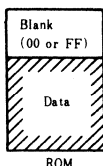

(3) Case when data is input by skipping intermediate address

The address of the address size of the data recorder is counted in increments of 1 byte of the data, compared with the next address of the data recorder and checked whether or not it is sequential. The data 00 automatically enters by hexadecimal notation into the ROM code of the skipped address. Therefore, the writing of data as in the following drawing is also possible. In this case, perform entry into the "ROM Specification Identification Sheet" that the ROM head address enters from 0 address for data I and from which address it enters for data II.

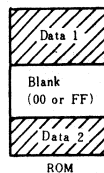

(4) Case when the data is less than the full capacity of ROM

In case the data volume is less than the total byte capacity of ROM LSI when the end of file recorder appears, it becomes written as the ROM code as shown in the following drawing.

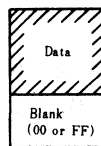

(Example) Indicates the example of the paper tape when the data recorder is S1141920B6-FC ...

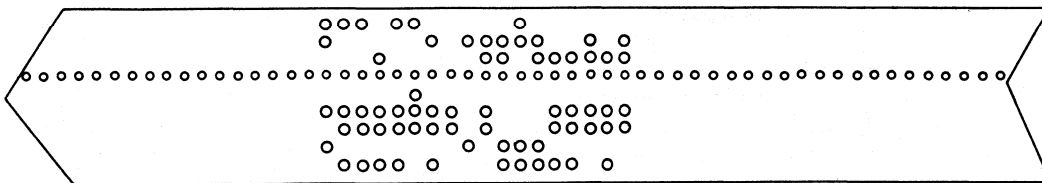

S 1 1 2 B F F 4 4
1 4 9 0 6 C 4 6 6

2.2 BNPF Mode

2.2.1 One word is symbolized by the word start mark B, the bit content represented by 8 characters of P and N, and the BNPF slice composed of successive 10 characters of the work end mark F.

2.2.2 The contents from F of one BNPF slice up to B of the next BNPF slice are ignored.

(Example) The code of 0F by hexadecimal notation is symbolized as shown below (in case of paper tape)

2.2.3 It is necessary to designate the bit pattern (BNPF slice) on all ROM addresses. Therefore, the term of the ROM head address of "ROM Specifica-

tion Identification Sheet" always becomes 0.

- B Indicates start of 1 word.
- N Indicates "0" of 1 bit data.
- P Indicates "1" of 1 bit data.
- F Indicates end of 1 word.

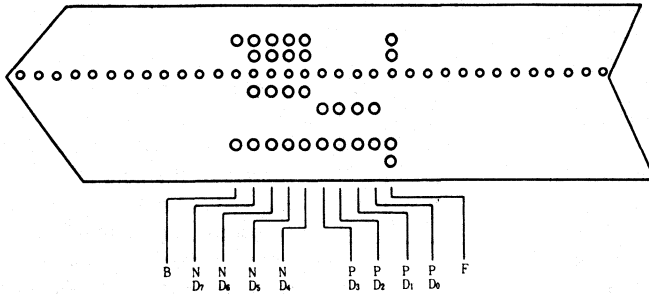

Note 1) Sometimes X is used besides P and N in the display of the word content by the BNPf slice.

X means that the user is not concerned whether the bit is P or N. However, since it is necessary to decide the P or N for performing tests, Hitachi performs selection of P or N. The results are informed by making entry in the identification table.

Note 2) The contents of the BNPf slice are not only those with the continuation of PN and the form of B*nF can also be used. This means that the content of the slice existing just prior to this word will be repeated for n words from this word.

For example, when B*4F exists at the 10th word, it means that the content of the 9th word will be repeated in the 10th, 11th, 12th and 13th words. (However, it does not necessarily follow that the X content of Note 1 above will be repeated.) n shall start from 1 and be a number below the total addresses of ROM.

Note 3) When a certain block is not used (when an unused ROM address exists), disposition can be made by utilizing Notes 1 and 2.

Mask ROM Development Flowchart

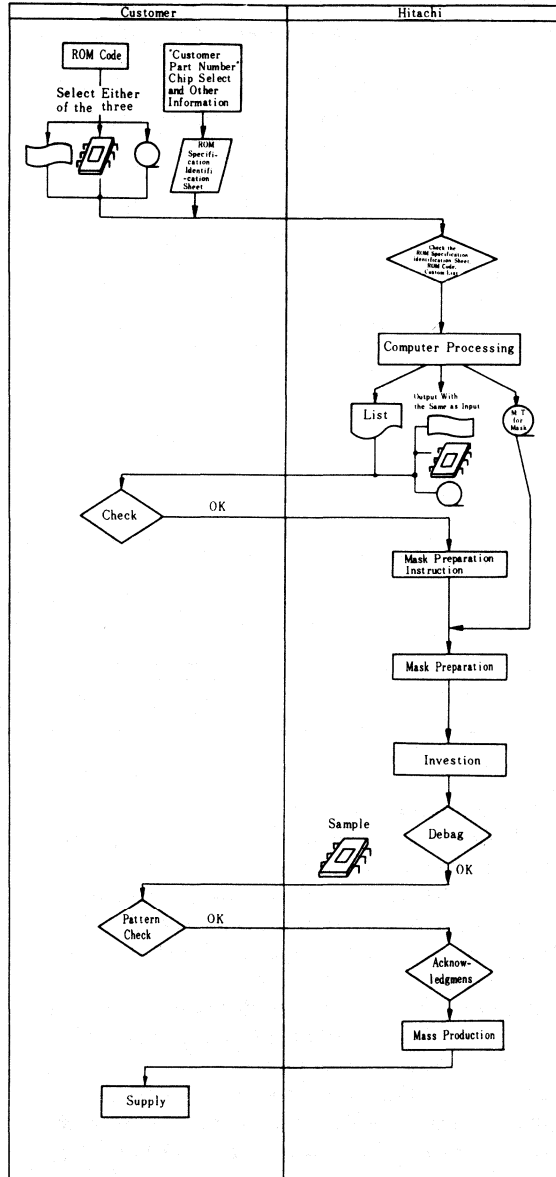

DATA SHEETS

MOS STATIC RAM

HM4334-3, HM4334-4 HM4334P-3, HM4334P-4

1024-word × 4-bit Static CMOS RAM

FEATURES

- Single 5V Supply
- Low Power Standby and Low Power Operation; Standby: 10μW (typ.)
Operation: 20mW (typ.)
- Access Time; HM4334/P-3: 300 ns (max.) (5V±5%)
HM4334/P-4: 450 ns (max.) (5V±10%)
- Directly TTL Compatible: All inputs and outputs
- Common Data Input and Output using Three-state Outputs
- On Chip Address Register

BLOCK DIAGRAM

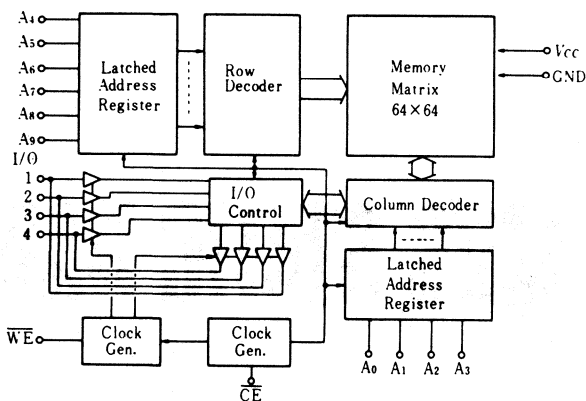

ABSOLUTE MAXIMUM RATINGS

Item	Symbol	Rating	Unit
Voltage On Any Pin*	V_T	-0.3 to $V_{CC} + 0.5$	V
Power Supply Voltage*	V_{CC}	-0.3 to +7.0	V
Power Dissipation	P_T	1.0	W
Operating Temperature	T_{opr}	0 to +70	°C
Storage Temperature (Plastic)	T_{stg}	-55 to +125	°C
Storage Temperature (Cerdip)	T_{stg}	-65 to +150	°C

* with respect to GND

HM4334-3, HM4334-4

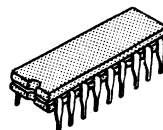

(DG-18)

HM4334P-3, HM4334P-4

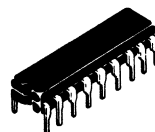

(DP-18)

PIN ARRANGEMENT

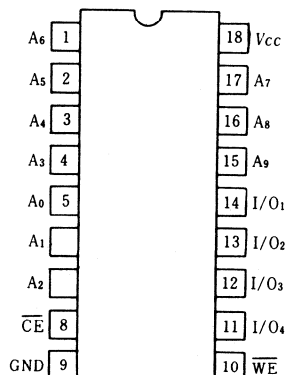

(Top View)

■ RECOMMENDED DC OPERATING CONDITIONS ($T_a=0$ to $+70^\circ\text{C}$)

Item	Symbol	HM4334/P-3			HM4334/P-4			Unit
		min	typ	max	min	typ	max	
Supply Voltage	V_{CC}	4.75	5.0	5.25	4.5	5.0	5.5	V
	GND	0	0	0	0	0	0	V
Input Voltage	V_{IH}	2.4	—	$V_{CC}+0.5$	2.4	—	$V_{CC}+0.5$	V
	V_{IL}	-0.3	—	0.8	-0.3	—	0.8	V

■ DC AND OPERATING CHARACTERISTICS

($T_a=0$ to $+70^\circ\text{C}$, GND=0V, HM4334/P-3 : $V_{CC}=5\text{V}\pm 5\%$, HM4334/P-4 : $V_{CC}=5\text{V}\pm 10\%$)

Item	Symbol	Test Condition	min	typ	max	Unit
Input Leakage Current	I_{LI}	$V_{IN}=0$ to V_{CC}	-1.0	—	+1.0	μA
Output Leakage Current	I_{LO}	$\overline{\text{CE}}=V_{IH}$, $V_{out}=0$ to V_{CC}	-1.0	—	+1.0	μA
Operating Power Supply Current	I_{CC1}	$\overline{\text{CE}}=0\text{V}$, $V_{IN}=V_{CC}$, $I_{I/O}=0$	—	—	1.0	mA
	I_{CC2}	$\overline{\text{CE}}=0.8\text{V}$, $V_{IN}=2.4\text{V}$, $I_{I/O}=0$	—	2.5	5.0	mA
Average Operating Current	I_{CC3}	$V_{IN}=0$ or V_{CC} , $f=1\text{MHz}$, duty 50%, $I_{I/O}=0$	—	4	7	mA
Standby Power Supply Current	I_{CCL}	$\overline{\text{CE}}\geq V_{CC}-0.2\text{V}$	—	2	100	μA
Output Voltage	V_{OL}	$I_{OL}=2.0\text{mA}$	—	—	0.4	V
	V_{OH}	$I_{OH}=-1.0\text{mA}$	2.4	—	—	V

■ CAPACITANCE ($T_a=25^\circ\text{C}$, $f=1\text{MHz}$)

Item	Symbol	Test Condition	min	typ	max	Unit
I/O Terminal Capacitance	$C_{I/O}$	$V_{I/O}=0\text{V}$	—	7	10	pF
Input Capacitance	C_{in}	$V_{in}=0\text{V}$	—	3	5	pF

■ AC CHARACTERISTICS

($T_a=0$ to $+70^\circ\text{C}$, GND=0V, HM4334/P-3 : $V_{CC}=5\text{V}\pm 5\%$, HM4334/P-4 : $V_{CC}=5\text{V}\pm 10\%$)

Item	Symbol		HM4334/P-3			HM4334/P-4			Unit
			min	typ	max	min	typ	max	
Read or Write Cycle Time*	TELEL	t_c	460	—	—	640	—	—	ns
Chip Enable Access Time	TELQV	t_{AC}	—	—	300	—	—	450	ns
Chip Enable to Output Active	TELQX	t_{CX}	50	—	—	50	—	—	ns
Output 3-state from Deselection	TEHQZ	t_{OFF1}	—	—	100	—	—	100	ns
Write Enable Output Disable Time	TWLQZ	t_{OFF2}	—	—	100	—	—	100	ns
Chip Enable Pulse Width**	TELEH	t_{CE}	300	—	—	450	—	—	ns
Chip Enable Precharge Time	TEHEL	t_P	120	—	—	150	—	—	ns
Address Hold Time	TELAX	t_{AH}	100	—	—	100	—	—	ns
Address Setup Time	TAVEL	t_{AS}	20	—	—	20	—	—	ns
Read Setup Time	TWHEL	t_{RS}	0	—	—	0	—	—	ns
Read Hold Time	TEHWL	t_{RH}	0	—	—	0	—	—	ns
Write Enable Setup Time	TWLEL	t_{WS}	-20	—	—	-20	—	—	ns
$\overline{\text{WE}}$ to $\overline{\text{CE}}$ Precharge Lead Time	TWLEH	t_{WPL}	300	—	—	450	—	—	ns
Chip Enable to Write Enable Delay Time	TELWL	t_{CWD}	300	—	—	450	—	—	ns
Write Enable Hold Time	TEHWH	t_{EWH}	0	—	—	0	—	—	ns
Write Hold Time	TELWH	t_{WH}	300	—	—	450	—	—	ns
Data Input Setup Time	TDVWH TDVEH	t_{DS}	200	—	—	350	—	—	ns
Data Hold Time	TWHDX TEHDX	t_{DH}	0	—	—	0	—	—	ns
Write Data Delay Time	TWLDV	t_{WDS}	100	—	—	100	—	—	ns
Chip Enable Rise/Fall Time	TT	t_T	—	—	300	—	—	300	ns

* TELEL(t_c) = TELEH(t_{CE}) + TEHEL(t_P) + t_r (20ns) + t_f (20ns)

** For Read Modify Write Cycle, TELEH(t_{CE}) = TELWL(t_{CWD}) + TWLEH(t_{WPL}) + t_f (20ns)

■ AC TEST CONDITIONS

Input Level 2.4V, 0.8V
 Input Rise and Fall Time 20ns
 Timing Measurement Level 2.4V, 0.8V
 Reference Level $V_{OH} = 2.0V, V_{OL} = 0.8V$
 Output Load 1 TTL and $C_L = 100\text{ pF}$

● READ CYCLE

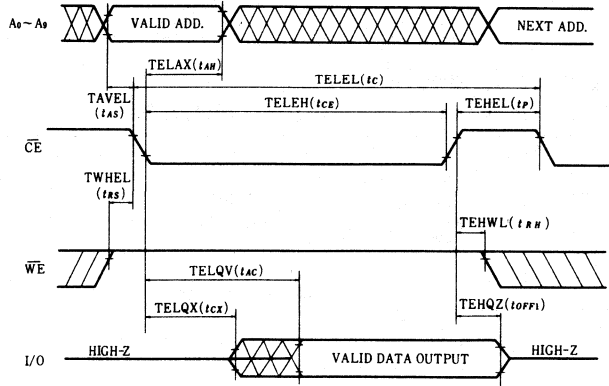

Note) *: TEHQZ (t_{OFF1}) defines the time at which the outputs achieve the open circuit condition and is not referenced to output voltage levels.

● WRITE CYCLE

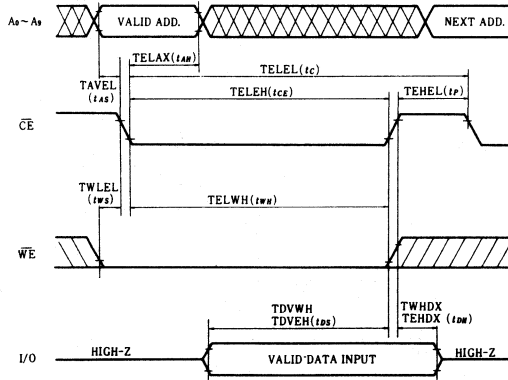

Note) t_{DS} and t_{DH} are measured from the earlier of \overline{CE} or \overline{WE} going high.

● READ MODIFY WRITE CYCLE

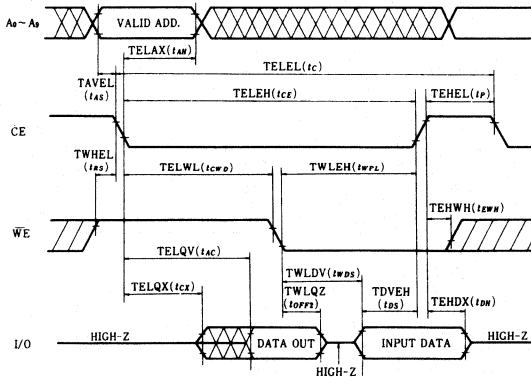

*: TWLQZ (t_{OFF2}) defines the time at which the outputs achieve the open circuit condition and is not referenced to output voltage levels.

● CURRENT WAVEFORM

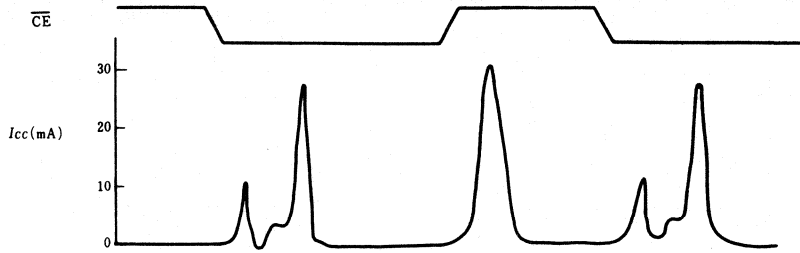

[NOTE] $V_{CC} = 5.0V, T_a = 25^{\circ}C$

■ LOW V_{CC} DATA RETENTION CHARACTERISTICS ($T_a = 0$ to $+70^{\circ}C$)

Item	Symbol	Test Condition	min	typ	max	Unit
V_{CC} for Data Retention	V_{DR}	$\overline{CE} \geq V_{CC} - 0.2V$	2.0	—	—	V
Data Retention Power Supply Current	I_{CCDR}	$V_{DR} = 3.0V$	—	0.5	50	μA
Chip Deselection to Data Retention Time	t_{CDR}		0	—	—	ns
Operation Recovery Time	t_R		t_{RC}^*	—	—	ns

* t_{RC} = Read Cycle Time

● LOW V_{CC} DATA RETENTION TIMING

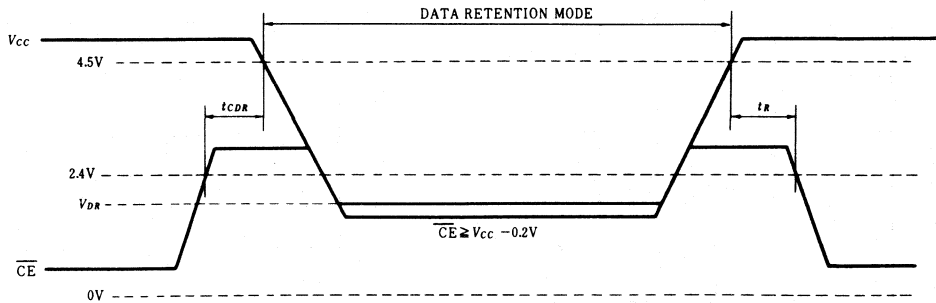

SUPPLY CURRENT vs. SUPPLY VOLTAGE

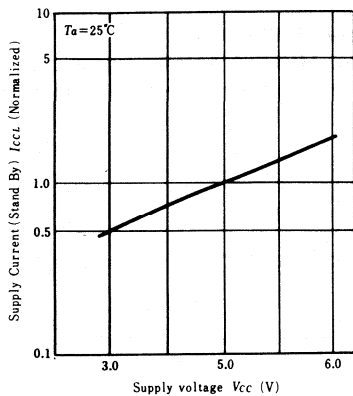

SUPPLY CURRENT vs. AMBIENT TEMPERATURE

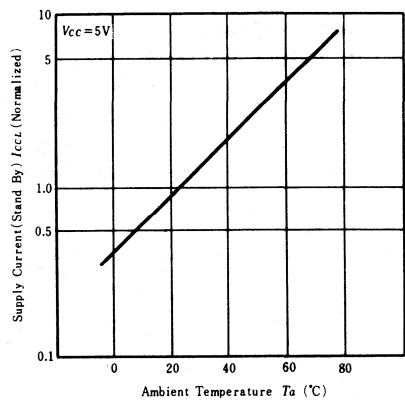

ACCESS TIME vs. SUPPLY VOLTAGE

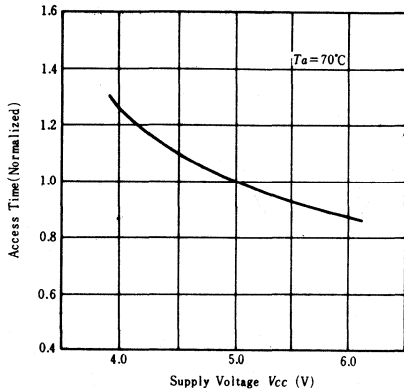

ACCESS TIME vs. AMBIENT TEMPERATURE

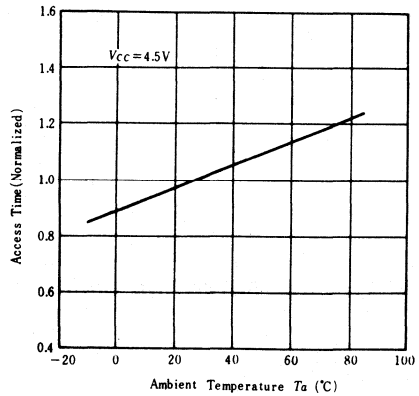

AVERAGE SUPPLY CURRENT vs. SUPPLY VOLTAGE

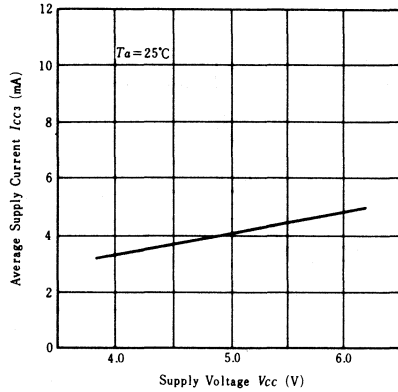

AVERAGE SUPPLY CURRENT vs. AMBIENT TEMPERATURE

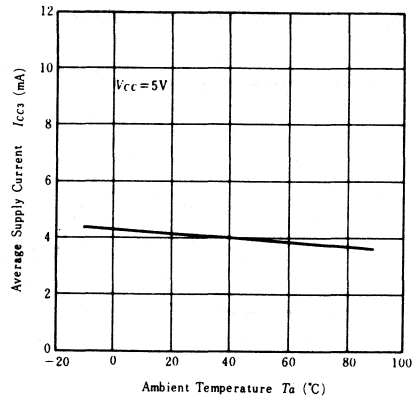

INPUT VOLTAGE vs. SUPPLY VOLTAGE

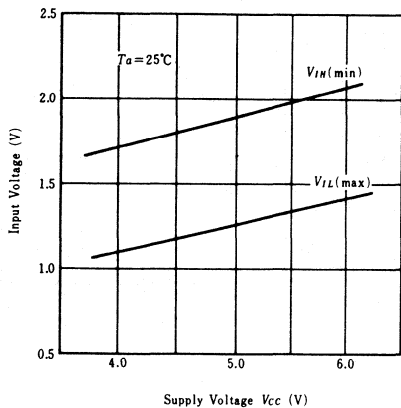

INPUT VOLTAGE vs. AMBIENT TEMPERATURE

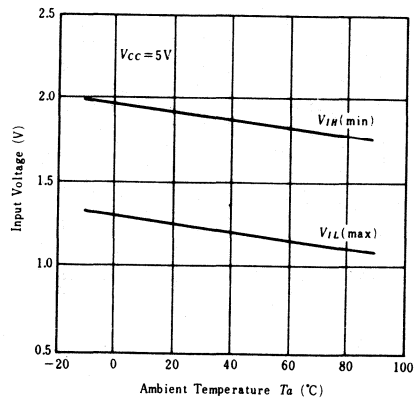

HM4334P-3L, HM4334P-4L

1024-word × 4-bit Static CMOS RAM

FEATURES

- Single 5V Supply
- Low Power Standby and Low Power Operation; Standby: 10μW (typ.)
Operation: 20mW (typ.)
- Fast Access Time; HM4334P-3L: 300 ns (max.) (5V±5%)
HM4334P-4L: 450 ns (max.) (5V±10%)
- Directly TTL Compatible: All inputs and outputs
- Common Data Input and Output using Three-state Outputs
- On Chip Address Register

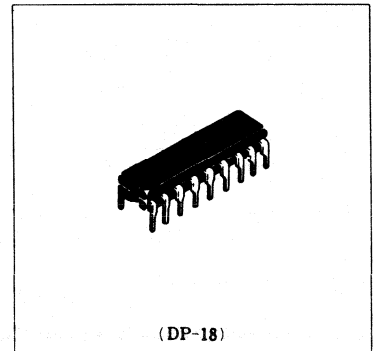

BLOCK DIAGRAM

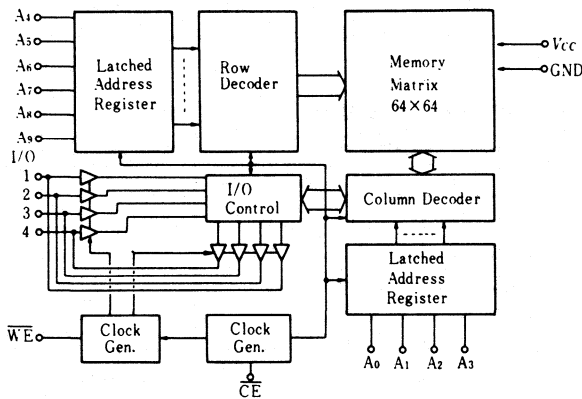

PIN ARRANGEMENT

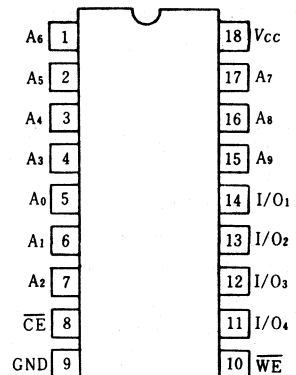

ABSOLUTE MAXIMUM RATINGS

Item	Symbol	Rating	Unit
Voltage On Any Pin*	V_T	-0.3 to $V_{CC}+0.5$	V
Power Supply Voltage*	V_{CC}	-0.3 to +7.0	V
Power Dissipation	P_T	1.0	W
Operating Temperature	T_{op}	0 to +70	°C
Storage Temperature	T_{stg}	-55 to +125	°C

* with respect to GND

RECOMMENDED DC OPERATING CONDITIONS ($T_a=0$ to +70°C)

Item	Symbol	HM4334P-3L			HM4334P-4L			Unit
		min	typ	max	min	typ	max	
Supply Voltage	V_{CC}	4.75	5.0	5.25	4.5	5.0	5.5	V
	GND	0	0	0	0	0	0	V
Input Voltage	V_{IH}	2.4	—	$V_{CC}+0.5$	2.4	—	$V_{CC}+0.5$	V
	V_{IL}	-0.3	—	0.8	-0.3	—	0.8	V

■DC AND OPERATING CHARACTERISTICS

($T_a=0$ to $+70^\circ\text{C}$, $\text{GND}=0\text{V}$, HM4334P-3L : $V_{CC}=5\text{V}\pm 5\%$, HM4334P-4L : $V_{CC}=5\text{V}\pm 10\%$)

Item	Symbol	Test Condition	min	typ	max	Unit
Input Leakage Current	I_{LI}	$V_{IN}=0$ to V_{CC}	-1.0	—	+1.0	μA
Output Leakage Current	I_{LO}	$\overline{\text{CE}}=V_{IH}$, $V_{out}=0$ to V_{CC}	-1.0	—	+1.0	μA
Operating Power Supply Current	I_{CC1}	$\overline{\text{CE}}=0\text{V}$, $V_{IN}=V_{CC}$, $I_{I/O}=0$	—	—	1.0	mA
	I_{CC2}	$\overline{\text{CE}}=0.8\text{V}$, $V_{IN}=2.4\text{V}$, $I_{I/O}=0$	—	2.5	5.0	mA
Average Operating Current	I_{CC3}	$V_{IN}=0$ or V_{CC} , $f=1\text{MHz}$, duty 50%, $I_{I/O}=0$	—	4	7	mA
Standby Power Supply Current	I_{CCL}	$\overline{\text{CE}}\geq V_{CC}-0.2\text{V}$	—	2	20	μA
Output Voltage	V_{OL}	$I_{OL}=2.0\text{mA}$	—	—	0.4	V
	V_{OH}	$I_{OH}=-1.0\text{mA}$	2.4	—	—	V

■CAPACITANCE ($T_a=25^\circ\text{C}$, $f=1\text{MHz}$)

Item	Symbol	Test Condition	min	typ	max	Unit
I/O Terminal Capacitance	$C_{I/O}$	$V_{I/O}=0\text{V}$	—	7	10	pF
Input Capacitance	C_{in}	$V_{in}=0\text{V}$	—	3	5	pF

■AC CHARACTERISTICS

($T_a=0$ to $+70^\circ\text{C}$, $\text{GND}=0\text{V}$, HM4334P-3L : $V_{CC}=5\text{V}\pm 5\%$, HM4334P-4L : $V_{CC}=5\text{V}\pm 10\%$)

Item	Symbol		HM4334P-3L			HM4334P-4L			Unit
			min	typ	max	min	typ	max	
Read or Write Cycle Time*	TELEL	t_C	460	—	—	640	—	—	ns
Chip Enable Access Time	TELQV	t_{AC}	—	—	300	—	—	450	ns
Chip Enable to Output Active	TELQX	t_{CX}	50	—	—	50	—	—	ns
Output 3-state from Deselection	TEHQZ	t_{OFF1}	—	—	100	—	—	100	ns
Write Enable Output Disable Time	TWLQZ	t_{OFF2}	—	—	100	—	—	100	ns
Chip Enable Pulse Width**	TELEH	t_{CE}	300	—	—	450	—	—	ns
Chip Enable Precharge Time	TEHEL	t_P	120	—	—	150	—	—	ns
Address Hold Time	TELAX	t_{AH}	100	—	—	100	—	—	ns
Address Setup Time	TAVEL	t_{AS}	20	—	—	20	—	—	ns
Read Setup Time	TWHEL	t_{RS}	0	—	—	0	—	—	ns
Read Hold Time	TEHWL	t_{RH}	0	—	—	0	—	—	ns
Write Enable Setup Time	TWLEL	t_{WS}	-20	—	—	-20	—	—	ns
$\overline{\text{WE}}$ to $\overline{\text{CE}}$ Precharge Lead Time	TWLEH	t_{WPL}	300	—	—	450	—	—	ns
Chip Enable to Write Enable Delay Time	TELWL	t_{CWD}	300	—	—	450	—	—	ns
Write Enable Hold Time	TEHWH	t_{EWH}	0	—	—	0	—	—	ns
Write Hold Time	TELWH	t_{WH}	300	—	—	450	—	—	ns
Data Input Setup Time	TDVWH TDVEH	t_{DS}	200	—	—	350	—	—	ns
Data Hold Time	TWHDX TEHDX	t_{DH}	0	—	—	0	—	—	ns
Write Data Delay Time	TWLDV	t_{WDS}	100	—	—	100	—	—	ns
Chip Enable Rise/Fall Time	TT	t_T	—	—	300	—	—	300	ns

* $\text{TELEL}(t_C) = \text{TELEH}(t_{CE}) + \text{TEHEL}(t_P) + t_{(20\text{ns})} + t_{(20\text{ns})}$

** For Read Modify Write Cycle, $\text{TELEH}(t_{CE}) = \text{TELWL}(t_{CWD}) + \text{TWLEH}(t_{WPL}) + t_{(20\text{ns})}$

■ AC TEST CONDITIONS

Input Level	2.4V, 0.8V
Input Rise and Fall Time	20ns
Timing Measurement Level	2.4V, 0.8V
Reference Level	$V_{OH} = 2.0V, V_{OL} = 0.8V$
Output Load	1 TTL and $C_L = 100pF$

● READ CYCLE

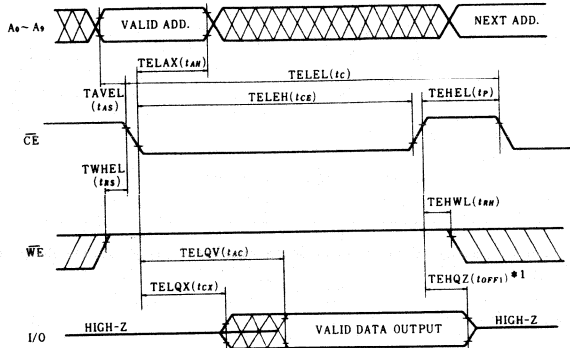

NOTE) *: $TEHQZ (t_{OFF1})$ defines the time at which the outputs achieve the open circuit condition and is not referenced to outputs voltage level.

● WRITE CYCLE

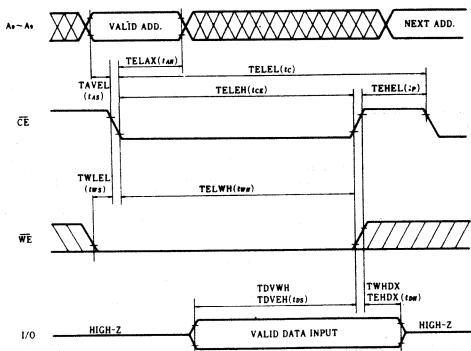

NOTE) t_{DS} and t_{DH} are measured from the earlier of \overline{CE} or \overline{WE} going high.

● READ MODIFY WRITE CYCLE

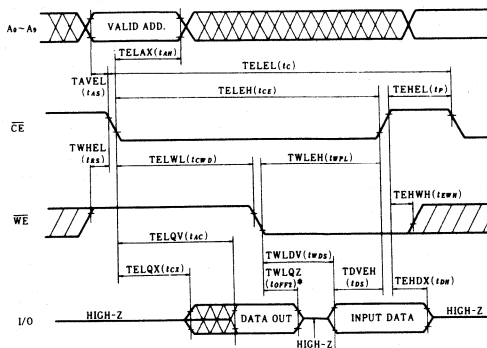

NOTE) *: $TWLQZ (t_{OFF2})$ defines the time at which the outputs achieve the open circuit condition and is not referenced to output voltage levels.

● CURRENT WAVEFORM

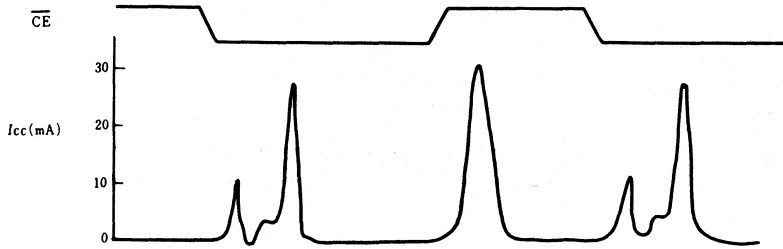

[NOTE] $V_{CC} = 5.0V, T_a = 25^\circ C$

■ LOW V_{CC} DATA RETENTION CHARACTERISTICS ($T_a = 0$ to $+70^\circ C$)

Item	Symbol	Test Condition	min	typ	max	Unit
V_{CC} for Data Retention	V_{DR}	$CE \geq V_{CC} - 0.2V$	2.0	—	—	V
Data Retention Power Supply Current	I_{CCDR}	$V_{DR} = 3.0V$	—	0.5	10	μA
Chip Deselection to Data Retention Time	t_{CDR}		0	—	—	ns
Operation Recovery Time	t_R		t_{RC}^*	—	—	ns

* t_{RC} - Read Cycle Time

● LOW V_{CC} DATA RETENTION TIMING

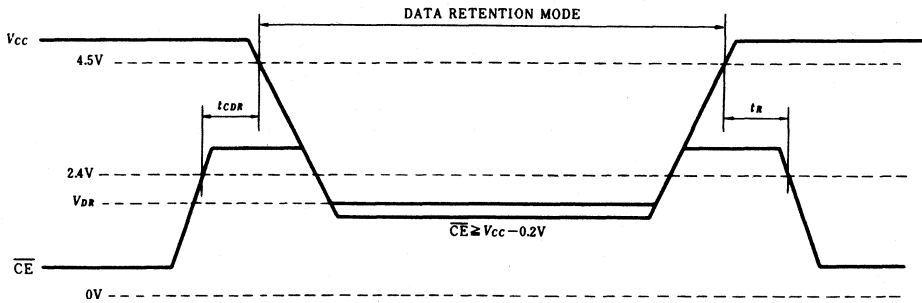

SUPPLY CURRENT (Standby)
vs. SUPPLY VOLTAGE

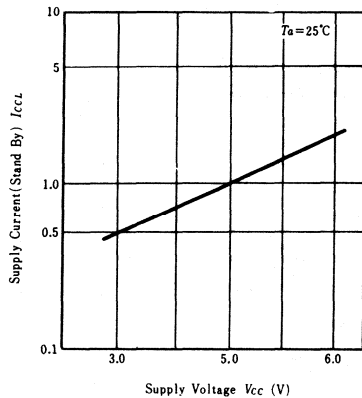

SUPPLY CURRENT (Standby)
vs. AMBIENT TEMPERATURE

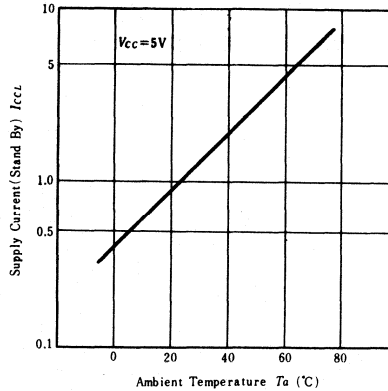

ACCESS TIME vs. SUPPLY VOLTAGE

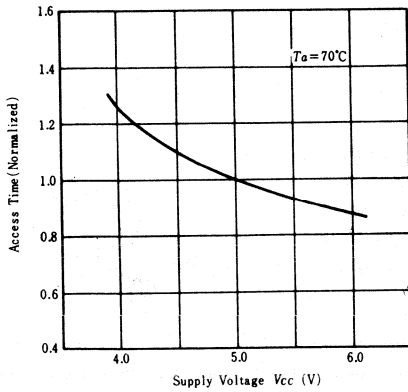

ACCESS TIME vs. AMBIENT TEMPERATURE

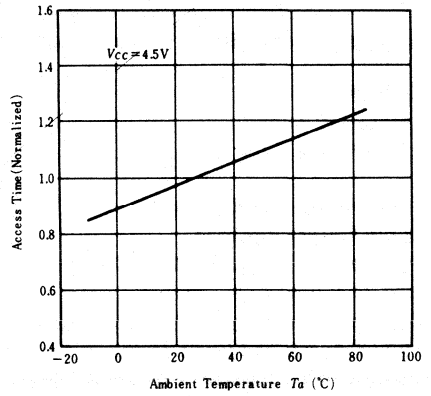

AVERAGE SUPPLY CURRENT vs. SUPPLY VOLTAGE

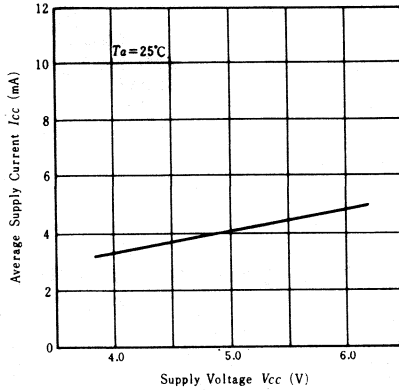

AVERAGE SUPPLY CURRENT vs. AMBIENT TEMPERATURE

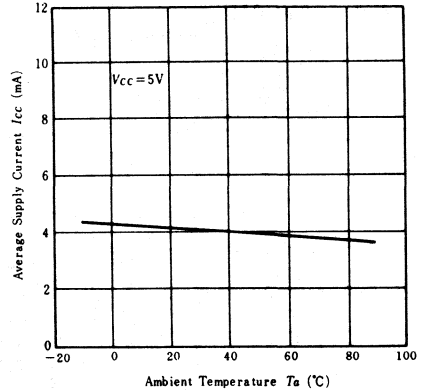

INPUT VOLTAGE vs. SUPPLY VOLTAGE

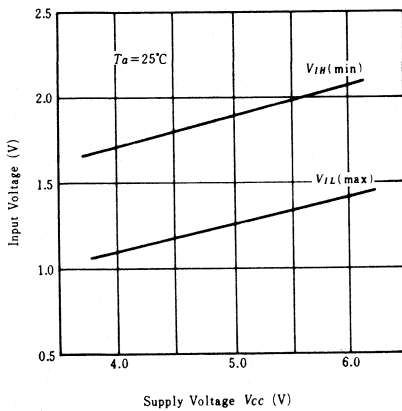

INPUT VOLTAGE vs. AMBIENT TEMPERATURE

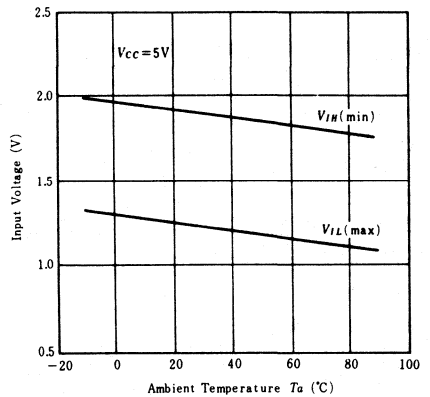

HM6148, HM6148-6 HM6148P, HM6148P-6

1024-word × 4-bit High Speed CMOS RAM

FEATURES

- Single 5V Supply
- Fast Access Time HM6148/P 70 ns (max.)
HM6148P-6 85 ns (max.)
- Low Power Standby and Low Power Operation; Standby: 100μW (typ)
Operation: 200mW (typ)
- Completely Static RAM; No Clock or Timing Strobe Required
- No Peak Power-On Current
- No Change of t_{ACS} with Short Deselected Time
- Equal Access and Cycle Times
- Directly TTL Compatible; All Inputs and Outputs
- Three State Output
- Common Data Input and Output
- Pin-Out Compatible with Intel 2148

BLOCK DIAGRAM

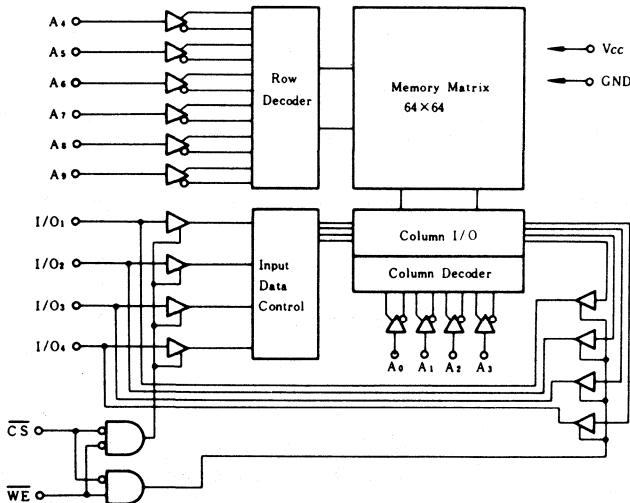

ABSOLUTE MAXIMUM RATINGS

Item	Symbol	Value	Unit
Terminal Voltage*	V_T	-0.5 Δ to +7.0	V
Power Dissipation	P_T	1.0	W
Operating Temperature	T_{opr}	0 to +70	°C
Storage Temperature (Plastic)	T_{stg}	-55 to +125	°C
Storage Temperature (Cerdip)	T_{stg}	-65 to +150	°C
Storage Temperature**	$T_{stg(bias)}$	-10 to +85	°C

* with respect to GND. Δ -1.0V (Pulse Width \leq 50ns)

** Under Bias

TRUTH TABLE

\overline{CS}	\overline{WE}	Mode	V_{CC} Current	I/O Pin	Reference Cycle
H	\times	Not Selected	I_{SB}, I_{SB1}	High Z	
L	H	Read	I_{CC}	Dout	Read Cycle
L	L	Write	I_{CC}	Din	Write Cycle

HM6148, HM6148-6

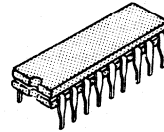

(DG-18)

HM6148P, HM6148P-6

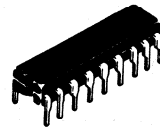

(DP-18)

PIN ARRANGEMENT

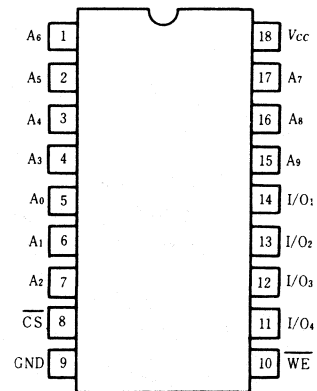

(Top View)

RECOMMENDED DC OPERATING CONDITIONS ($T_a=0$ to $+70^\circ\text{C}$)

Item	Symbol	min	typ	max	Unit
Supply Voltage	V_{CC}	4.5	5.0	5.5	V
	GND	0	0	0	V
Input Voltage	V_{IH}	2.4	3.5	6.0	V
	V_{IL}	-0.3*	—	0.8	V

* V_{IL} min = -1.0V (Pulse width $\leq 50\text{ns}$)

DC AND OPERATING CHARACTERISTICS ($V_{CC}=5\text{V} \pm 10\%$, $\text{GND}=0\text{V}$, $T_a=0$ to $+70^\circ\text{C}$)

Item	Symbol	Test Condition	min	typ*	max	Unit
Input Leakage Current	$ I_{LI} $	$V_{CC}=5.5\text{V}$, $V_{in}=\text{GND to } V_{CC}$	—	—	2.0	μA
Output Leakage Current	$ I_{LO} $	$\overline{\text{CS}}=V_{IH}$, $V_{I/O}=\text{GND to } V_{CC}$	—	—	2.0	μA
Operating Power Supply Current	I_{CC}	$\overline{\text{CS}}=V_{IL}$, $I_{I/O}=0\text{mA}$	—	35	80	mA
	I_{CC1}	$\overline{\text{CS}}=V_{IL}$, Minimum Cycle, Duty=100%, $I_{I/O}=0\text{mA}$	—	40	80	mA
Average Operating Current	I_{CC2}^{**}	Cycle=150ns, Duty=50%, $I_{I/O}=0\text{mA}$	—	35	—	mA
Standby Power Supply Current	I_{SB}	$\overline{\text{CS}}=V_{IH}$	—	5	12	mA
	I_{SB1}	$\overline{\text{CS}} \geq V_{CC}-0.2\text{V}$, $V_{in} \leq 0.2\text{V}$ or $V_{in} \geq V_{CC}-0.2\text{V}$	—	20	800	μA
Output Voltage	V_{OL}	$I_{OL}=8\text{mA}$	—	—	0.4	V
	V_{OH}	$I_{OH}=-3.2\text{mA}$	2.4	—	—	V

Notes) * Typical limits are at $V_{CC}=5.0\text{V}$, $T_a=25^\circ\text{C}$ and specified loading.
 ** Reference only.

CAPACITANCE ($T_a=25^\circ\text{C}$, $f=1\text{MHz}$)

Item	Symbol	Test Condition	min	max	Unit
Input Capacitance	C_{in}	$V_{in}=0\text{V}$	—	5	pF
Input/Output Capacitance	$C_{I/O}$	$V_{I/O}=0\text{V}$	—	12	pF

Note) This parameter is sampled and not 100% tested.

AC CHARACTERISTICS ($V_{CC}=5\text{V} \pm 10\%$, $T_a=0$ to $+70^\circ\text{C}$, unless otherwise noted)

AC TEST CONDITIONS

- Input Pulse Levels GND to 3.0V
- Input Rise and Fall Times 10ns
- Input and Output Timing Reference Levels 1.5V
- Output Load See Figure 1

Load Circuit (A)

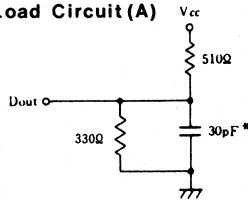

Load Circuit (B)

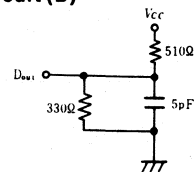

* includes probe and jig capacitance

Fig. 1

READ CYCLE

Parameter	Symbol	HM6148/P		HM6148/P-6		Unit
		min	max	min	max	
Read Cycle Time	t_{RC}	70	—	85	—	ns
Address Access Time	t_{AA}	—	70	—	85	ns
Chip Select Access Time	t_{ACS}	—	70	—	85	ns
Output Hold from Address Change	t_{OH}	5	—	5	—	ns
Chip Selection to Output in Low Z*	t_{LZ}	10	—	10	—	ns
Chip Deselection to Output in High Z*	t_{HZ}	0	40	0	40	ns
Chip Selection to Power Up Time	t_{PU}	0	—	0	—	ns
Chip Deselection to Power Down Time	t_{PD}	—	40	—	40	ns

* Transition is measured $\pm 500\text{mV}$ from high impedance voltage with Load B. This parameter is sampled and not 100% tested.

● TIMING WAVEFORM OF READ CYCLE NO.1 ^{(1) (2)}

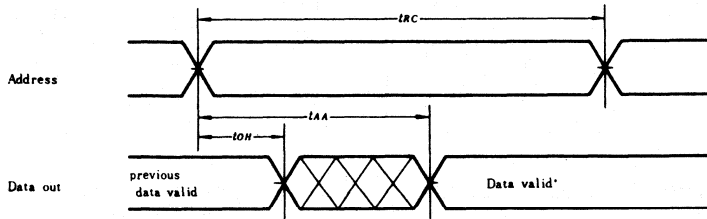

● TIMING WAVEFORM OF READ CYCLE NO.2 ^{(1) (3)}

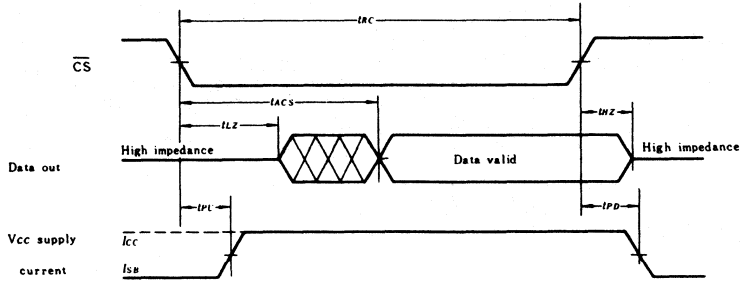

- NOTES) 1. \overline{WE} is high for Read Cycle.
 2. Device is continuously selected, $\overline{CS} = V_{IL}$.
 3. Address Valid prior to or coincident with \overline{CS} transition low.

■ WRITE CYCLE

Parameter	Symbol	HM6148/P		HM6148/P-6		Unit
		min	max	min	max	
Write Cycle Time	t_{WC}	70	—	85	—	ns
Chip Selection to End of Write	t_{CW}	50	—	60	—	ns
Address Valid to End of Write	t_{AW}	65	—	80	—	ns
Address Setup Time	t_{AS}	15	—	15	—	ns
Write Pulse Width*	t_{WP1}	50	—	60	—	ns
	t_{WP2}	65	—	80	—	ns
Write Recovery Time	t_{WR}	5	—	5	—	ns
Data Valid to End of Write	t_{DW}	30	—	35	—	ns
Data Hold Time	t_{DH}	5	—	5	—	ns
Write Enabled to Output in High Z**	t_{WZ}	0	35	0	45	ns
Output Active from End of Write**	t_{OW}	0	—	0	—	ns

Notes) * When the \overline{CS} low transition occurs simultaneously with the \overline{WE} low transition or after the \overline{WE} transition. I/O pins remain in a high impedance state. In this case t_{WP1} , in the other case $t_{WP2} (= t_{WZ} + t_{DW})$.

** Transition is measured $\pm 500mV$ from high impedance voltage with Load B. This parameter is sampled and not 100% tested.

● TIMING WAVEFORM OF WRITE CYCLE NO.1(WE CONTROLLED) ⁽¹⁾

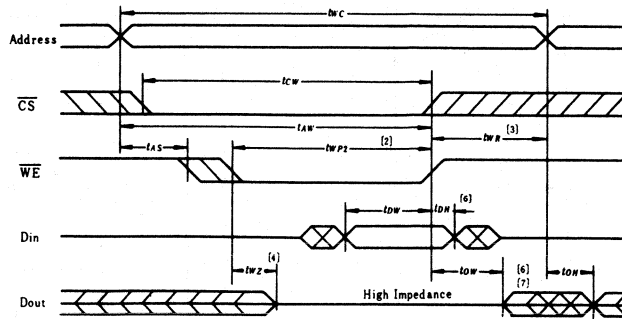

● TIMING WAVEFORM OF WRITE CYCLE NO.2(CS CONTROLLED) ⁽¹⁾

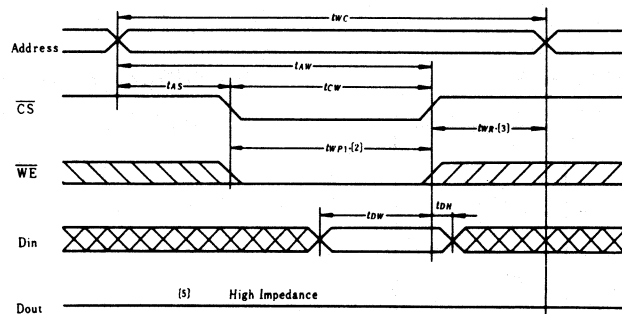

Notes)

1. \overline{CS} and \overline{WE} are paced in the WRITE state during low level period (t_W).
2. A write occurs during the overlap of a low \overline{CS} and a low \overline{WE} . (t_{WP})
3. t_{WR} is measured from the earlier of \overline{CS} or \overline{WE} going high to the end of write cycle.
4. During this period, I/O pins are in the output state so that the input signals of opposite phase to the outputs must not be applied.
5. If the \overline{CS} low transition occurs simultaneously with the \overline{WE} low transition or after the \overline{WE} transition, the output buffers remain in a high impedance state.
6. If \overline{CS} is low during this period, I/O pins are in the output state. Then the data input signals of opposite phase to the outputs must not be applied to them.
7. D_{out} is the same phase of write data of this write cycle.

ACCESS TIME vs. V_{CC}

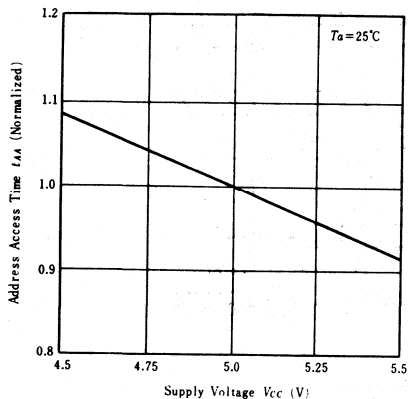

ACCESS TIME vs. T_a

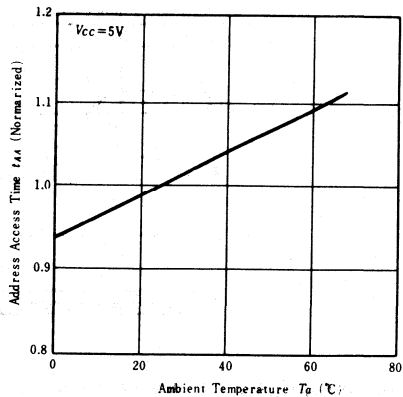

SUPPLY CURRENT vs. V_{CC}

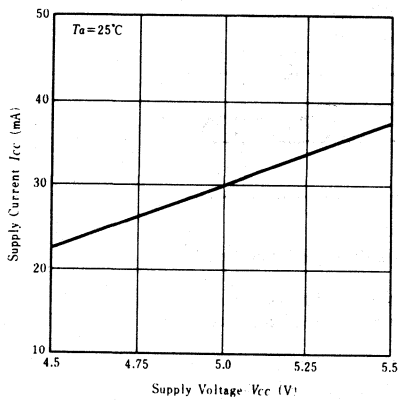

SUPPLY CURRENT vs. V_{CC}

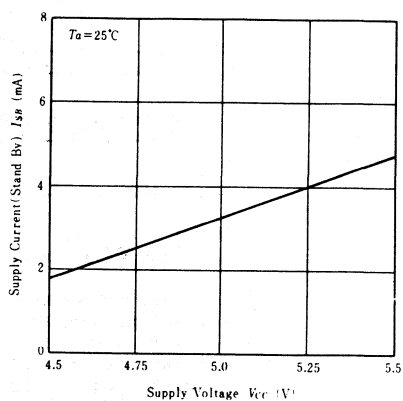

SUPPLY CURRENT vs. T_a

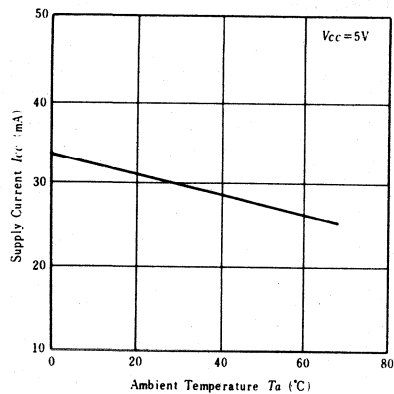

SUPPLY CURRENT vs. T_a

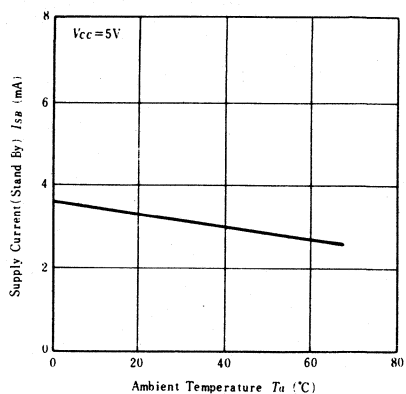

**SUPPLY CURRENT vs. V_{CC}
(STANDBY)**

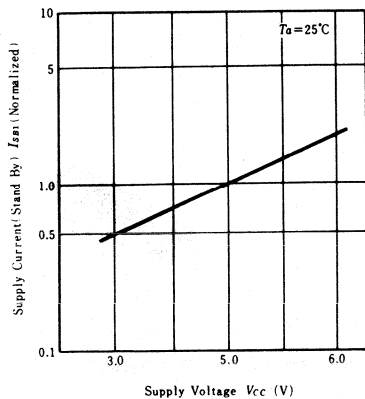

**SUPPLY CURRENT vs. T_a
(STANDBY)**

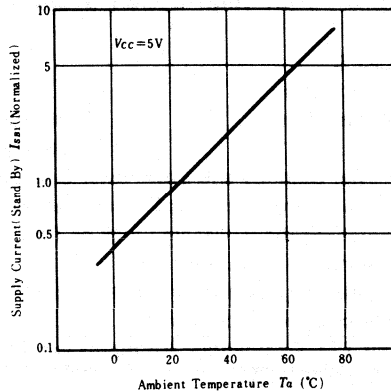

HM6148LP, HM6148LP-6

1024-word × 4-bit High Speed Static CMOS RAM

FEATURES

- Single 5V Supply
- Fast Access Time HM6148LP 70 ns (max.)
HM6148LP-6 85 ns (max.)
- Low Power Standby and Low Power Operation;
Standby: 5μW (typ) Operation: 200mW (typ)
- Completely Static RAM; No Clock or Timing Strobe Required
- No Peak Power-On Current
- No Change of t_{ACS} with Short Deselected Time
- Equal Access and Cycle Times
- Directly TTL Compatible; All Inputs and Outputs
- Three State Output
- Common Data Input and Output
- Capability of Battery Back Up Operation
- Pin-Out Compatible with Intel 2148

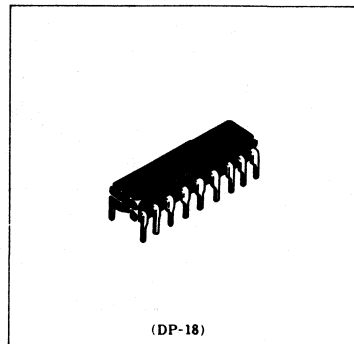

BLOCK DIAGRAM

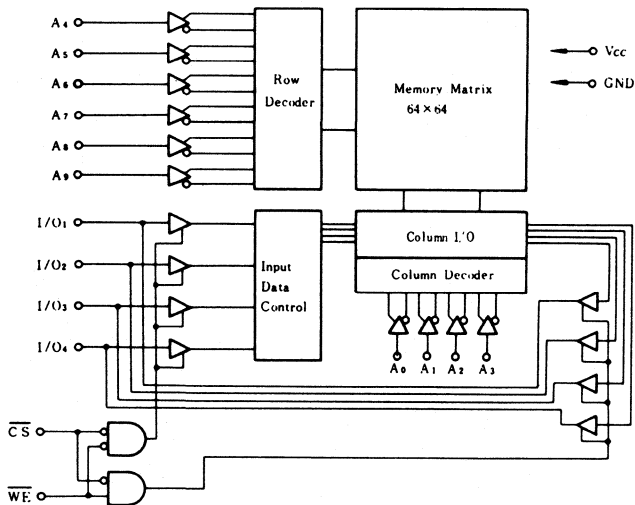

PIN ARRANGEMENT

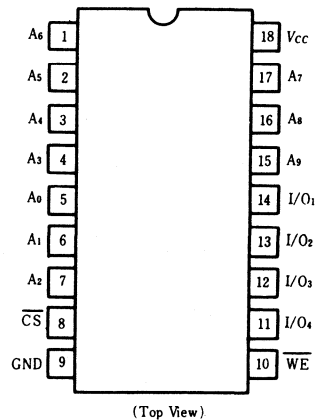

ABSOLUTE MAXIMUM RATINGS

Item	Symbol	Value	Unit
Terminal Voltage*	V_T	-0.5 to +7.0	V
Power Dissipation	P_T	1.0	W
Operating Temperature	T_{op}	0 to +70	°C
Storage Temperature	T_{stg}	-55 to +125	°C
Storage Temperature**	$T_{stg(bias)}$	-10 to +85	°C

* with respect to GND. Δ -1.0V (Pulse Width \leq 50ns)

** Under Bias

■ TRUTH TABLE

\overline{CS}	\overline{WE}	Mode	V_{CC} Current	I/O Pin	Reference Cycle
H	X	Not Selected	I_{SB}, I_{SB1}	High Z	
L	H	Read	I_{CC}	Dout	Read Cycle
L	L	Write	I_{CC}	Din	Write Cycle

■ RECOMMENDED DC OPERATING CONDITIONS ($T_a=0$ to $+70^\circ\text{C}$)

Item	Symbol	min	typ	max	Unit
Supply Voltage	V_{CC}	4.5	5.0	5.5	V
	GND	0	0	0	V
Input Voltage	V_{IH}	2.4	3.5	6.0	V
	V_{IL}	-0.3*	—	0.8	V

* V_{IL} min = -1.0V (Pulse width $\leq 50\text{ns}$)

■ DC AND OPERATING CHARACTERISTICS ($V_{CC}=5\text{V} \pm 10\%$, GND=0V, $T_a=0$ to $+70^\circ\text{C}$)

Item	Symbol	Test Condition	min	typ*	max	Unit
Input Leakage Current	$ I_{L1} $	$V_{CC}=5.5\text{V}$, $V_{in}=\text{GND to } V_{CC}$	—	—	2.0	μA
Output Leakage Current	$ I_{L0} $	$\overline{CS}=V_{IH}$, $V_{I/O}=\text{GND to } V_{CC}$	—	—	2.0	μA
Operating Power Supply Current	I_{CC}	$\overline{CS}=V_{IL}$, $I_{I/O}=0\text{mA}$	—	35	80	mA
Average Operating Current	I_{CC1}	$\overline{CS}=V_{IL}$, Minimum Cycle, Duty=100%, $I_{I/O}=0\text{mA}$	—	40	80	mA
	I_{CC2}^{**}	Cycle=150ns, Duty=50%, $I_{I/O}=0\text{mA}$	—	35	—	mA
Standby Power Supply Current	I_{SB}	$\overline{CS}=V_{IH}$	—	5	12	mA
	I_{SB1}	$\overline{CS} \geq V_{CC}-0.2\text{V}$, $V_{in} \leq 0.2\text{V}$ or $V_{in} \geq V_{CC}-0.2\text{V}$	—	1	100	μA
Output Voltage	V_{OL}	$I_{OL}=8\text{mA}$	—	—	0.4	V
	V_{OH}	$I_{OH}=-3.2\text{mA}$	2.4	—	—	V

Notes) * Typical limits are at $V_{CC}=5.0\text{V}$, $T_a=25^\circ\text{C}$ and specified loading.
 ** Reference only.

■ CAPACITANCE ($T_a=25^\circ\text{C}$, $f=1\text{MHz}$)

Item	Symbol	Test Condition	min	max	Unit
Input Capacitance	C_{in}	$V_{in}=0\text{V}$	—	5	pF
Input/Output Capacitance	$C_{I/O}$	$V_{I/O}=0\text{V}$	—	12	pF

Note) This parameter is sampled and not 100% tested.

■ AC CHARACTERISTICS ($V_{CC}=5\text{V} \pm 10\%$, $T_a=0$ to $+70^\circ\text{C}$, unless otherwise noted)

● AC TEST CONDITIONS

- Input Pulse Levels GND to 3.0V
- Input Rise and Fall Times 10ns
- Input and Output Timing Reference Levels 1.5V
- Output Load See Figure

Load Circuit (A)

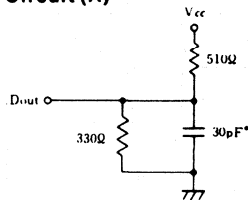

* includes probe and jig capacitance.

Load Circuit (B)

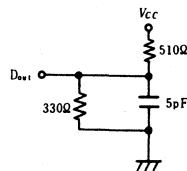

● READ CYCLE

Parameter	Symbol	HM6148LP		HM6148LP-6		Unit
		min	max	min	max	
Read Cycle Time	t_{RC}	70	—	85	—	ns
Address Access Time	t_{AA}	—	70	—	85	ns
Chip Select Access Time	t_{ACS}	—	70	—	85	ns
Output Hold from Address Change	t_{OH}	5	—	5	—	ns
Chip Selection to Output in Low Z*	t_{LZ}	10	—	10	—	ns
Chip Deselection to Output in High Z*	t_{HZ}	0	40	0	40	ns
Chip Selection to Power Up Time	t_{PU}	0	—	0	—	ns
Chip Deselection to Power Down Time	t_{PD}	—	40	—	40	ns

* Transition is measured $\pm 500mV$ from high impedance voltage with Load B. This parameter is sampled and not 100% tested.

● TIMING WAVEFORM OF READ CYCLE NO.1 ^{(1) (2)}

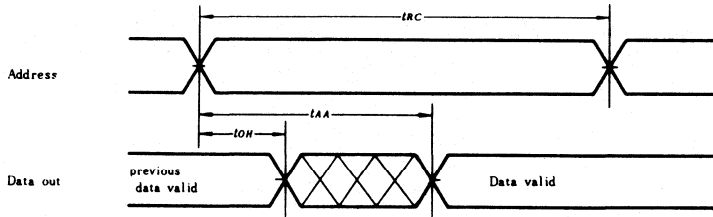

● TIMING WAVEFORM OF READ CYCLE NO.2 ^{(1) (3)}

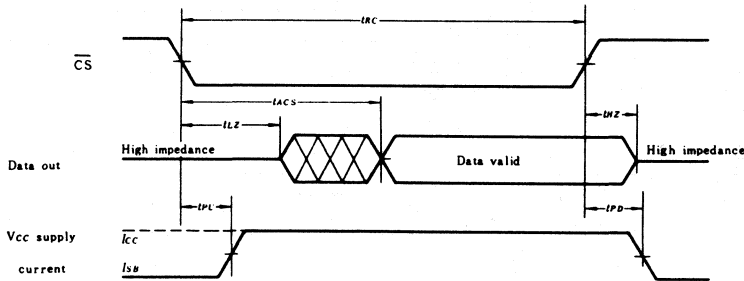

- NOTES) 1. \overline{WE} is high for Read Cycle.
 2. Device is continuously selected, $\overline{CS} = V_{IL}$
 3. Address Valid prior to or coincident with \overline{CS} transition low.

● WRITE CYCLE

Parameter	Symbol	HM6148LP		HM6148LP-6		Unit
		min	max	min	max	
Write Cycle Time	t_{WC}	70	—	85	—	ns
Chip Selection to End of Write	t_{CW}	50	—	60	—	ns
Address Valid to End of Write	t_{AW}	65	—	80	—	ns
Address Setup Time	t_{AS}	15	—	15	—	ns
Write Pulse Width*	t_{WP1}	50	—	60	—	ns
	t_{WP2}	65	—	80	—	ns
Write Recovery Time	t_{WR}	5	—	5	—	ns
Data Valid to End of Write	t_{DW}	30	—	35	—	ns
Data Hold Time	t_{DH}	5	—	5	—	ns
Write Enabled to Output in High Z**	t_{WZ}	0	35	0	45	ns
Output Active from End of Write**	t_{OW}	0	—	0	—	ns

Notes) * When the \overline{CS} low transition occurs simultaneously with the \overline{WE} low transition or after the \overline{WE} transition, I/O pins remain in a high impedance state. In this case t_{WP1} , in the other case $t_{WP2} (= t_{WZ} + t_{OW})$.

** Transition is measured $\pm 500mV$ from high impedance voltage with Load B. This parameter is sampled and not 100% tested.

● TIMING WAVEFORM OF WRITE CYCLE NO.1 (\overline{WE} CONTROLLED) ⁽¹⁾

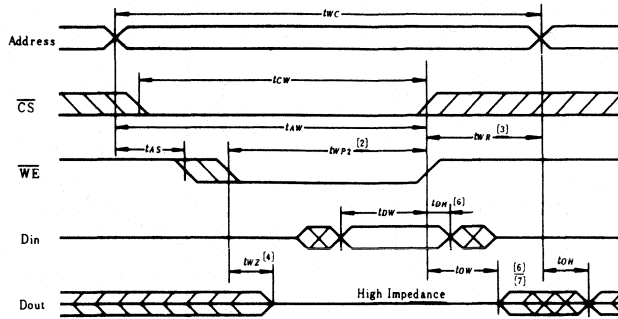

● TIMING WAVEFORM OF WRITE CYCLE NO.2 (\overline{CS} CONTROLLED) ⁽¹⁾

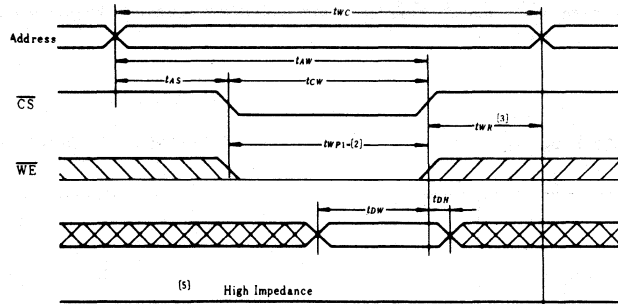

Notes)

1. \overline{CS} and \overline{WE} are paced in the WRITE state during low level period (t_W).
2. A write occurs during the overlap of a low \overline{CS} and a low \overline{WE} . (t_{WP})
3. t_{WR} is measured from the earlier of \overline{CS} or \overline{WE} going high to the end of write cycle.
4. During this period, I/O pins are in the output state so that the input signals of opposite phase to the outputs must not be applied.
5. If the \overline{CS} low transition occurs simultaneously with the \overline{WE} low transition or after the \overline{WE} transition, the output buffers remain in a high impedance state.
6. If \overline{CS} is low during this period, I/O pins are in the output state. Then the data input signals of opposite phase to the outputs must not be applied to them.
7. Dout is the same phase of write data of this write cycle.

■ LOW V_{CC} DATA RETENTION CHARACTERISTICS ($T_a=0$ to $+70^\circ\text{C}$)

Parameter	Symbol	Test Condition	min	typ	max	Unit
V_{CC} for Data Retention	V_{DR}	$\overline{CS} \geq V_{CC} - 0.2\text{V}$, $V_{IN} \geq V_{CC} - 0.2\text{V}$ or $V_{IN} \leq 0.2\text{V}$	2.0	—	—	V
Data Retention Current	I_{CCDR}	$V_{CC} = 2.0\text{V}$, $\overline{CS} \geq 1.8\text{V}$, $V_{IN} = 1.8\text{V}$ or $V_{IN} \leq 0.2\text{V}$	—	—	40	μA
Chip Deselect to Data Retention Time	t_{CDR}	See Retention Waveform	0	—	—	ns
Operation Recovery Time	t_R		t_{RC}^*	—	—	ns

* t_{RC} - Read Cycle Time

● LOW V_{CC} DATA RETENTION WAVEFORM

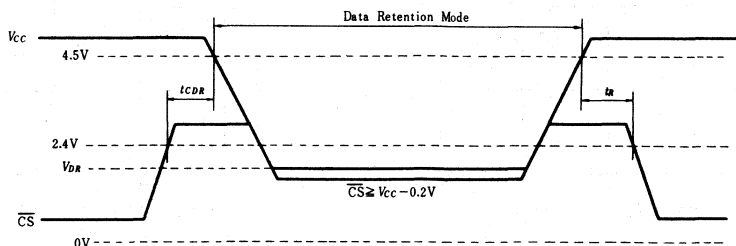

ACCESS TIME vs. V_{CC}

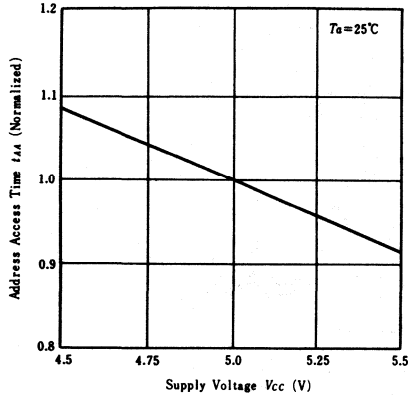

ACCESS TIME vs. T_a

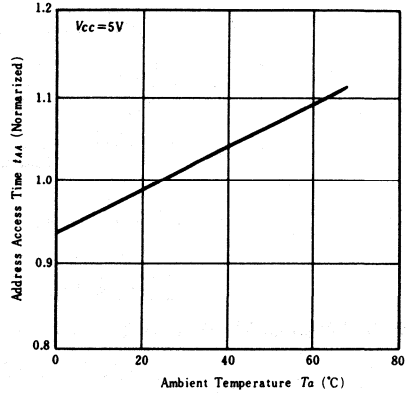

SUPPLY CURRENT vs. V_{CC}

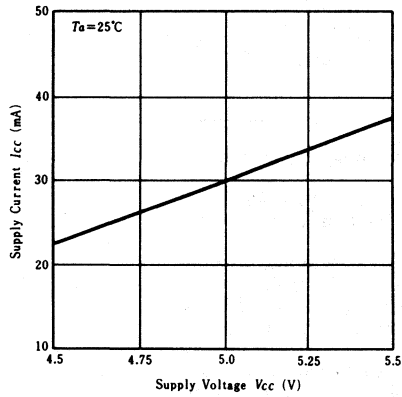

SUPPLY CURRENT vs. V_{CC}

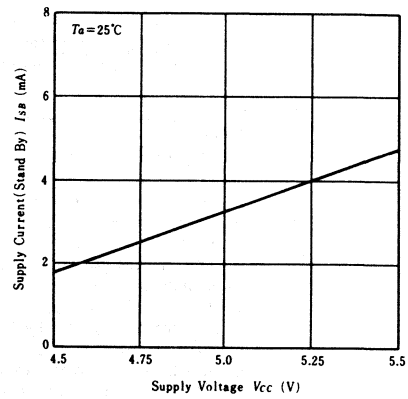

SUPPLY CURRENT vs. T_a

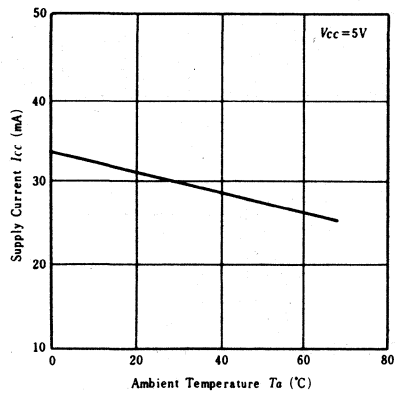

SUPPLY CURRENT vs. T_a

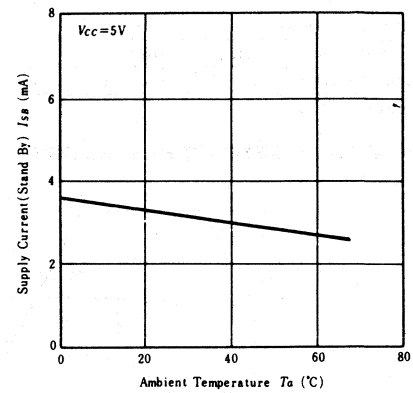

**SUPPLY CURRENT vs. V_{CC}
(STANDBY)**

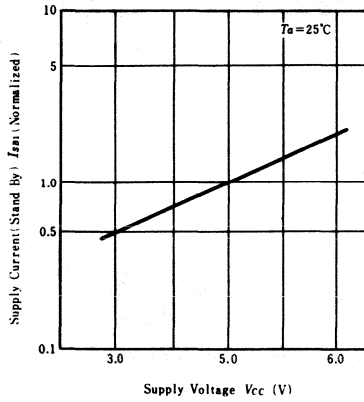

**SUPPLY CURRENT vs. T_a
(STANDBY)**

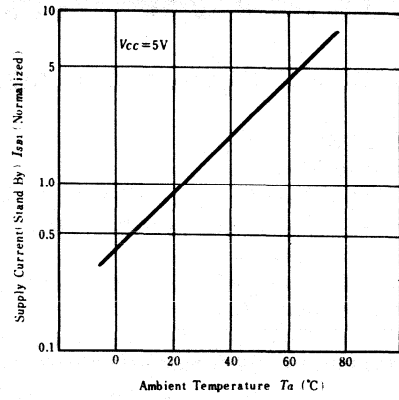

HM6148H-35, HM6148H-45, HM6148H-55, HM6148HP-35, HM6148HP-45, HM6148HP-55

Preliminary

1024-word x 4-bit High Speed Static CMOS RAM

FEATURES

- Fast Access Time 35/45/55ns (max)
- Low Power Standby and Low Power Operation;
Standby: 100 μ W (typ.), Operation: 200mW (typ.)
- Single 5V Supply
- Completely Static RAM: No Clock or Timing Strobe Required
- No Peak Power-On Current
- No Change of t_{ACS} with Short Deselected Time
- Equal Access and Cycle Times
- Directly TTL Compatible; All Inputs and Outputs
- Common Data Input and Output; Three-State Outputs
- Pin-Out Compatible with Intel 2148H

BLOCK DIAGRAM

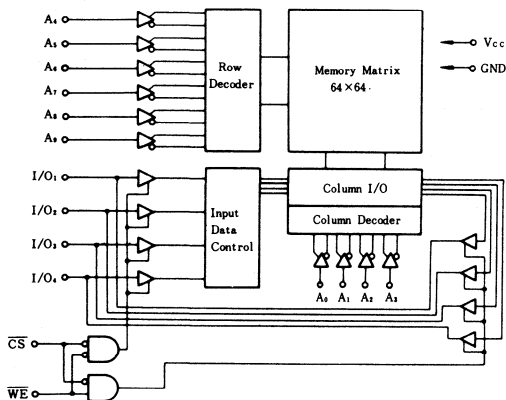

ABSOLUTE MAXIMUM RATINGS

Item	Symbol	Ratings	Unit
Terminal Voltage*	V_T	-0.5 to +7.0	V
Power Dissipation	P_T	1.0	W
Operating Temperature	T_{opr}	0 to +70	$^{\circ}$ C
Storage Temperature (Plastic)	T_{stg}	-55 to +125	$^{\circ}$ C
Storage Temperature (Ceramic)	T_{stg}	-65 to +150	$^{\circ}$ C
Storage Temperature**	T_{bias}	-10 to +85	$^{\circ}$ C

* with respect to GND. $V_{IL_{min}} = -3.5V$ (Pulse width=20ns)

** under bias

TRUTH TABLE

\overline{CS}	\overline{WE}	Mode	V_{cc} Current	I/O Pin	Reference Cycle
H	\times	Not selected	I_{SB}, I_{SB1}	High Z	
L	H	Read	I_{cc}	Dout	Read Cycle 1, 2
L	L	Write	I_{cc}	Din	Write Cycle 1, 2

Note) The specifications of this device are subject to change without notice.

Please contact your nearest Hitachi's Sales Dept. regarding specifications.

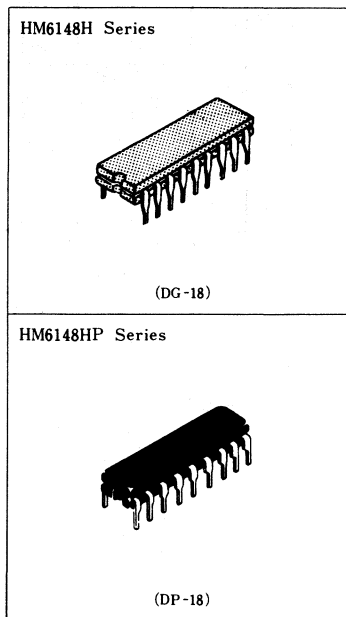

PIN ARRANGEMENT

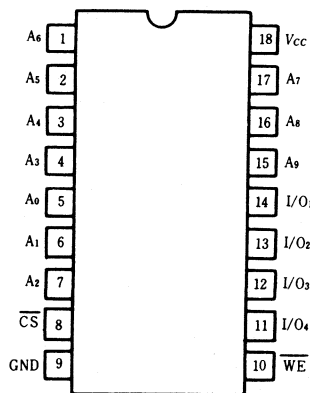

(Top View)

■ RECOMMENDED DC OPERATING CONDITIONS ($T_a=0$ to $+70^\circ\text{C}$)

Item	Symbol	min	typ	max	Unit
Supply Voltage	V_{CC}	4.5	5.0	5.5	V
	GND	0	0	0	V
Input Voltage	V_{IH}	2.2	—	6.0	V
	V_{IL}	-0.5*	—	0.8	V

* -3.0V (Pulse width 20ns)

■ DC AND OPERATING CHARACTERISTICS[1] ($T_a=0\sim 70^\circ\text{C}$, $V_{CC}=5V\pm 10\%$, GND=0V)

Parameter	Symbol	Test Conditions	min	typ	max	Unit	Notes
Input Leakage Current	$ I_{L1} $	$V_{CC}=\text{max}$, $V_{in}=\text{GND}$ to V_{CC}	—	—	2.0	μA	
Output Leakage Current	$ I_{L0} $	$\overline{\text{CS}}=V_{IH}$, $V_{I/O}=\text{GND}$ to V_{CC}	—	—	2.0	μA	
Operating Power Supply Current	I_{CC}	$\overline{\text{CS}}=V_{IL}$, $I_{I/O}=0\text{mA}$	—	35	80	mA	
Operating Power Supply Current: AC	I_{CC1}	min. cycle, $\overline{\text{CS}}=V_{IL}$, $I_{I/O}=0\text{mA}$	—	50	100	mA	(2)
Standby Power Supply Current: DC	I_{SB}	$\overline{\text{CS}}=V_{IH}$	—	5	20	mA	
Standby Power Supply Current(1): DC	I_{SB1}	$\overline{\text{CS}}\geq V_{CC}-0.2\text{V}$, $V_{IN}\leq 0.2\text{V}$ or $V_{IN}\geq V_{CC}-0.2\text{V}$	—	20	800	μA	
Output Low Voltage	V_{OL}	$I_{OL}=8\text{mA}$	—	—	0.4	V	
Output High Voltage	V_{OH}	$I_{OH}=-4.0\text{mA}$	2.4	—	—	V	

Notes) 1. Typical limits are at $V_{CC}=5.0\text{V}$, $T_a=+25^\circ\text{C}$ and specified loading.
2. 120mA max. for HM6148HP-35

■ CAPACITANCE ($T_a=25^\circ\text{C}$, $f=1\text{MHz}$)

Item	Symbol	Test Conditions	typ	max	Unit
Input Capacitance	C_{in}	$V_{in}=0\text{V}$	3	5	pF
Input/Output Capacitance	$C_{I/O}$	$V_{I/O}=0\text{V}$	5	7	pF

Note) This parameter is sampled and not 100% tested.

■ AC CHARACTERISTICS ($V_{CC}=5V\pm 10\%$, $T_a=0$ to $+70^\circ\text{C}$)

● RISE FALL TIME

Item	Symbol	min	typ	max	Unit
Input Rise Time	t_r	—	5	100	ns
Input Fall Time	t_f	—	5	100	ns

● AC TEST CONDITIONS

Input pulse levels: GND to 3.0V

Input rise and fall times: 5ns

Input and Output timing reference levels: 1.5V

Output load: See Figure

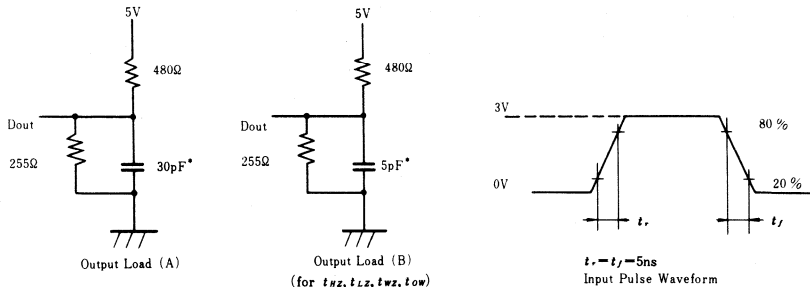

* Including scope & jig.

■ AC CHARACTERISTICS ($T_a=0$ to 70°C , $V_{CC}=5\text{V}\pm 10\%$, unless otherwise noted.)

● READ CYCLE

Item	Symbol	HM6148HP-35		HM6148HP-45		HM6148HP-55		Unit
		min	max	min	max	min	max	
Read Cycle Time	t_{RC}	35	—	45	—	55	—	ns
Address Access Time	t_{AA}	—	35	—	45	—	55	ns
Chip Select Access Time	t_{ACS}	—	35	—	45	—	55	ns
Output Hold from Address Change	t_{OH}	5	—	5	—	5	—	ns
Chip Selection to Output in Low Z	t_{LZ}^*	10	—	10	—	10	—	ns
Chip Deselection to Output in High Z	t_{HZ}^*	0	20	0	20	0	20	ns
Chip Selection to Power Up Time	t_{PU}	0	—	0	—	0	—	ns
Chip Deselection to Power Down Time	t_{PD}	—	30	—	30	—	30	ns

* Transition is measured $\pm 500\text{mV}$ from high impedance voltage with Load(B). This parameter is sampled and not 100% tested.
 At any temperature and voltage condition t_{HZ} max is less than t_{LZ} min.

● TIMING WAVEFORM OF READ CYCLE NO.1 ⁽¹⁾⁽²⁾

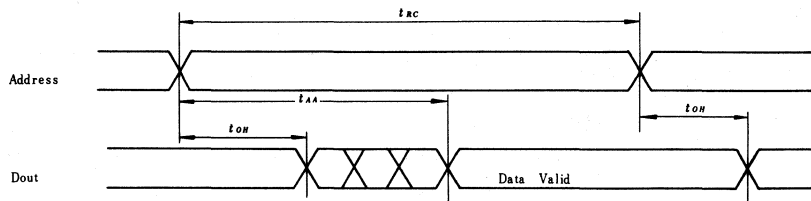

● TIMING WAVEFORM OF READ CYCLE NO.2 ⁽¹⁾⁽³⁾

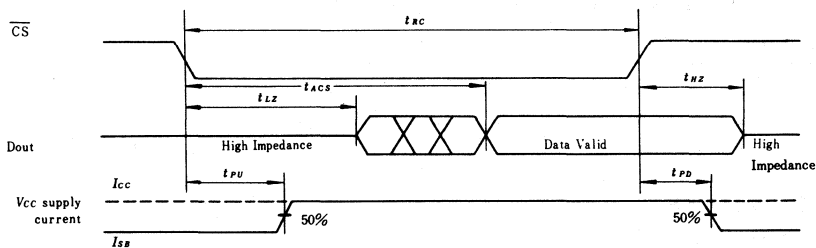

- Notes) 1. \overline{WE} is High for Read Cycle.
 2. Device is continuously selected, $\overline{CS} = V_{IL}$.
 3. Address Valid prior to or coincident with \overline{CS} transition Low.

● WRITE CYCLE

Item	Symbol	HM6148H/P-35		HM6148H/P-45		HM6148H/P-55		Unit
		min	max	min	max	min	max	
Write Cycle Time	t_{WC}	35	—	45	—	55	—	ns
Chip Selection to End of Write	t_{CW}	30	—	40	—	50	—	ns
Address Valid to End of Write	t_{AW}	30	—	40	—	50	—	ns
Address Setup Time	t_{AS}	0	—	0	—	0	—	ns
Write Pulse Width	t_{WP}	30	—	35	—	40	—	ns
Write Recovery Time	t_{WR}	5	—	5	—	5	—	ns
Data Valid to End of Write	t_{DW}	20	—	20	—	20	—	ns
Data Hold Time	t_{DH}	0	—	0	—	0	—	ns
Write Enabled to Output in High Z*	t_{WZ}	0	10	0	15	0	20	ns
Output Active from End of Write*	t_{OW}	0	—	0	—	0	—	ns

* Transition is measured ± 500 mV from high impedance voltage with Load B.
This parameter is sampled and not 100% tested.

● TIMING WAVEFORM OF WRITE CYCLE NO.1 (\overline{WE} Controlled)

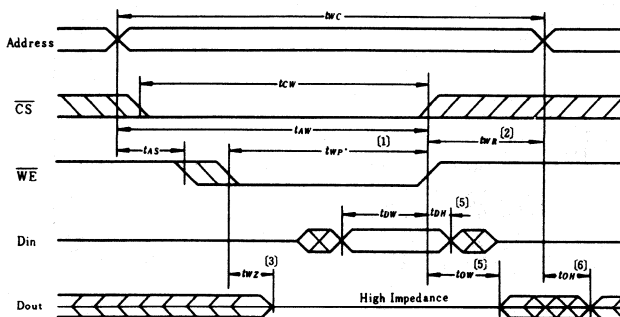

● TIMING WAVEFORM OF WRITE CYCLE NO.2 (\overline{CS} Controlled)

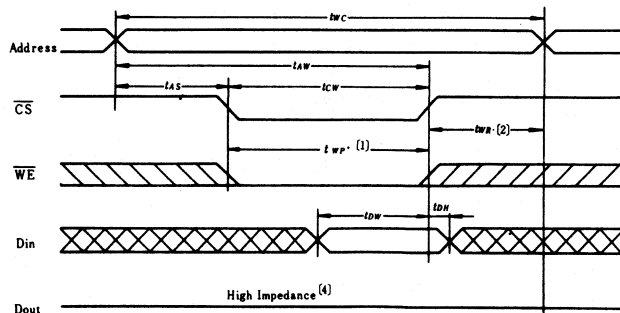

NOTES of Timing Waveform of Write

1. A write occurs during the overlap of a low \overline{CS} and a low \overline{WE} . (t_{WP})
2. t_{WR} is measured from the earlier of \overline{CS} or \overline{WE} going high to the end of write cycle.
3. During this period, I/O pins are in the output state so that the input signals of opposite phase to the outputs must not be applied.
4. If the \overline{CS} low transition occurs simultaneously with the \overline{WE} low transition or after the \overline{WE} transition, the output buffers remain in a high impedance state.
5. If \overline{CS} is low during this period, I/O pins are in the output state. Then the data input signals of opposite phase to the outputs must not be applied to them.
6. Dout is the same phase of write data of this write cycle.

HM6148HLP-35, HM6148HLP-45, HM6148HLP-55

Preliminary

1024-word × 4-bit High Speed Static CMOS RAM

■ FEATURES

- Low Power Standby and Low Power Operation; Standby: 5μW (typ.), Operation: 300mW (typ.)
- Fast Access Time: 35/45/55ns (max)
- Capability of Battery Back Up Operation
- Single 5V Supply
- Completely Static RAM: No Clock or Timing Strobe Required
- No Peak Power-On Current
- No Change of t_{ACS} with Short Deselected Time
- Equal Access and Cycle Time
- Directly TTL Compatible: All Inputs and Outputs
- Three State Output
- Pin-Out Compatible with Intel 2148H

■ BLOCK DIAGRAM

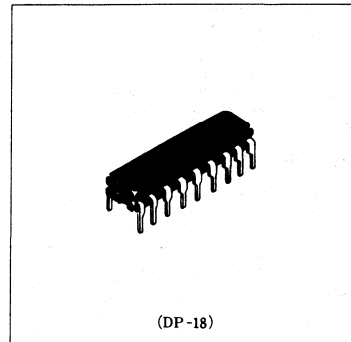
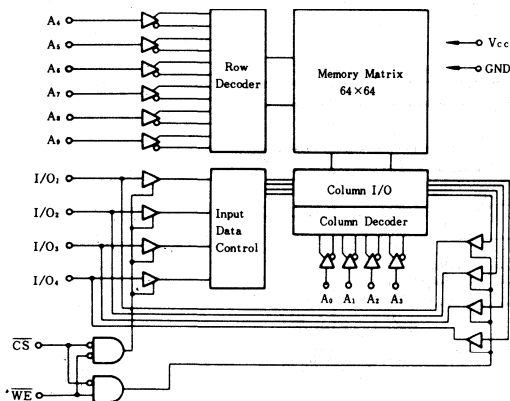

■ PIN ARRANGEMENT

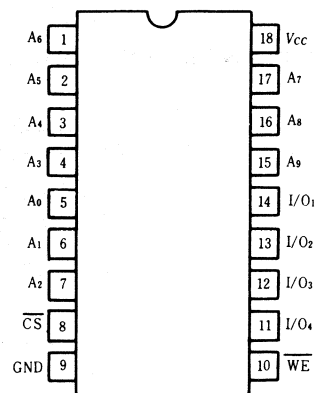

(Top View)

■ ABSOLUTE MAXIMUM RATINGS

Item	Symbol	Ratings	Unit
Terminal Voltage *	V_T	-0.5 to +7.0	V
Power Dissipation	P_T	1.0	W
Operating Temperature	T_{opr}	0 to +70	°C
Storage Temperature	T_{stg}	-55 to +125	°C
Storage Temperature **	T_{bias}	-10 to +85	°C

* with respect to GND. $V_{TL} = -3.5V$ (Pulse width = 20ns)
** under bias.

■ TRUTH TABLE

\overline{CS}	\overline{WE}	Mode	V_{CC} Current	I/O Pin	Reference Cycle
H	×	Not selected	I_{SB}, I_{SB1}	High Z	
L	H	Read	I_{CC}	Dout	Read Cycle 1, 2
L	L	Write	I_{CC}	Din	Write Cycle 1, 2

Note) The specifications of this device are subject to change without notice.

Please contact your nearest Hitachi's Sales Dept. regarding specifications.

RECOMMENDED DC OPERATING CONDITIONS ($T_a=0$ to $+70^\circ\text{C}$)

Item	Symbol	min	typ	max	Unit
Supply Voltage	V_{CC}	4.5	5.0	5.5	V
	GND	0	0	0	V
Input Voltage	V_{IH}	2.2	—	6.0	V
	V_{IL}	-0.5*	—	0.8	V

* -3.0V (Pulse width 20ns)

DC AND OPERATING CHARACTERISTICS[1] ($T_a=0\sim 70^\circ\text{C}$, $V_{CC}=5V\pm 10\%$, GND=0V)

Parameter	Symbol	Test Conditions	min	typ	max	Unit	Notes
Input Leakage Current	$ I_{LI} $	$V_{CC}=\text{max}$, $V_{in}=\text{GND to } V_{CC}$	—	—	2.0	μA	
Output Leakage Current	$ I_{LO} $	$\overline{\text{CS}}=V_{IH}$, $V_{I/O}=\text{GND to } V_{CC}$	—	—	2.0	μA	
Operating Power Supply Current : DC	I_{CC}	$\overline{\text{CS}}=V_{IL}$, $I_{I/O}=0\text{mA}$	—	35	80	mA	
Operating Power Supply Current : AC	I_{CC1}	min. cycle, $\overline{\text{CS}}=V_{IL}$, $I_{I/O}=0\text{mA}$	—	50	100	mA	[2]
Standby Power Supply Current : DC	I_{SB}	$\overline{\text{CS}}=V_{IH}$	—	5	20	mA	
Standby Power Supply Current(1): DC	I_{SB1}	$\overline{\text{CS}}\geq V_{CC}-0.2\text{V}$, $V_{IN}\leq 0.2\text{V}$ or $V_{IN}\geq V_{CC}-0.2\text{V}$	—	1	50	μA	
Output Low Voltage	V_{OL}	$I_{OL}=8\text{mA}$	—	—	0.4	V	
Output High Voltage	V_{OH}	$I_{OH}=-4.0\text{mA}$	2.4	—	—	V	

Notes) 1. Typical limits are at $V_{CC}=5.0\text{V}$, $T_a=+25^\circ\text{C}$ and specified loading.
 2. 120mA max. for HM6148HLP-35

CAPACITANCE ($T_a=25^\circ\text{C}$, $f=1\text{MHz}$)

Item	Symbol	Test Conditions	typ	max	Unit
Input Capacitance	C_{in}	$V_{in}=0\text{V}$	3	5	pF
Input/Output Capacitance	$C_{I/O}$	$V_{I/O}=0\text{V}$	5	7	pF

Note) This parameter is sampled and not 100% tested.

AC CHARACTERISTICS ($V_{CC}=5V\pm 10\%$, $T_a=0$ to $+70^\circ\text{C}$)

RISE FALL TIME

Item	Symbol	min	typ	max	Unit
Input Rise Time	t_r	—	5	100	ns
Input Fall Time	t_f	—	5	100	ns

AC TEST CONDITIONS

- Input pulse levels : GND to 3.0V
- Input rise and fall times : 5ns
- Input and Output timing reference levels : 1.5V
- Output load : See Figure

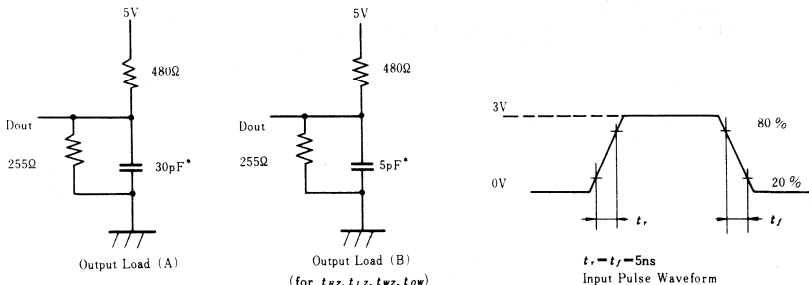

* Including scope & jig.

■ AC CHARACTERISTICS ($T_a=0$ to 70°C , $V_{CC}=5\text{V}\pm 10\%$, unless otherwise noted.)

● READ CYCLE

Item	Symbol	HM6148HLP-35		HM6148HLP-45		HM6148HLP-55		Unit
		min	max	min	max	min	max	
Read Cycle Time	t_{RC}	35	—	45	—	55	—	ns
Address Access Time	t_{AA}	—	35	—	45	—	55	ns
Chip Select Access Time	t_{ACS}	—	35	—	45	—	55	ns
Output Hold from Address Change	t_{OH}	5	—	5	—	5	—	ns
Chip Selection to Output in Low Z	t_{LZ}^*	10	—	10	—	10	—	ns
Chip Deselection to Output in High Z	t_{HZ}^*	0	20	0	20	0	20	ns
Chip Selection to Power Up Time	t_{PU}	0	—	0	—	0	—	ns
Chip Deselection to Power Down Time	t_{PD}	—	30	—	30	—	30	ns

* Transition is measured $\pm 500\text{mV}$ from high impedance voltage with Load(B). This parameter is sampled and not 100% tested.
 At any temperature and voltage condition t_{HZ} max is less than t_{LZ} min.

● TIMING WAVEFORM OF READ CYCLE NO.1 ⁽¹⁾⁽²⁾

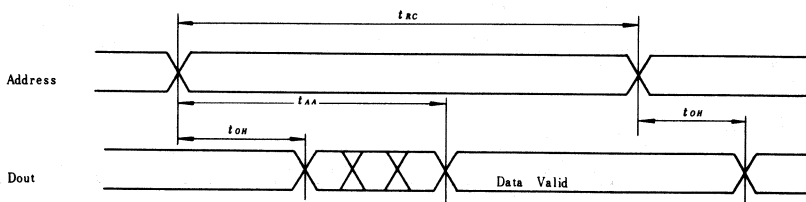

● TIMING WAVEFORM OF READ CYCLE NO.2 ⁽¹⁾⁽³⁾

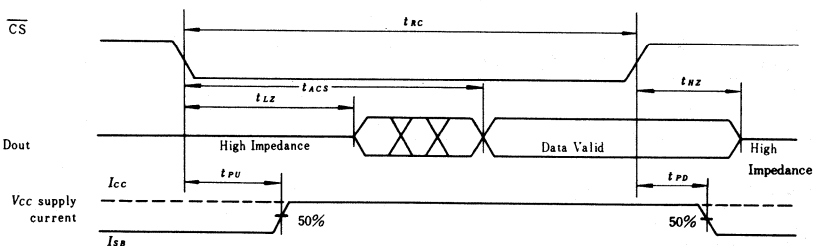

- Notes) 1. \overline{WE} is High for Read Cycle.
 2. Device is continuously selected, $\overline{CS} = V_{IL}$.
 3. Address Valid prior to or coincident with \overline{CS} transition Low.

● WRITE CYCLE

Item	Symbol	HM6148HLP-35		HM6148HLP-45		HM6148HLP-55		Unit
		min	max	min	max	min	max	
Write Cycle Time	t_{WC}	35	—	45	—	55	—	ns
Chip Selection to End of Write	t_{CW}	30	—	40	—	50	—	ns
Address Valid to End of Write	t_{AW}	30	—	40	—	50	—	ns
Address Setup Time	t_{AS}	0	—	0	—	0	—	ns
Write Pulse Width	t_{WP}	30	—	35	—	40	—	ns
Write Recovery Time	t_{WR}	5	—	5	—	5	—	ns
Data Valid to End of Write	t_{DW}	20	—	20	—	20	—	ns
Data Hold Time	t_{DH}	0	—	0	—	0	—	ns
Write Enabled to Output in High Z*	t_{WZ}	0	10	0	15	0	20	ns
Output Active from End of Write*	t_{OW}	0	—	0	—	0	—	ns

* Transition is measured ± 500 mV from high impedance voltage with Load B.
 This parameter is sampled and not 100% tested.
 All inputs t_r , t_f (rise and fall time) are less than 100ns.

● TIMING WAVEFORM OF WRITE CYCLE NO.1 (\overline{WE} Controlled)

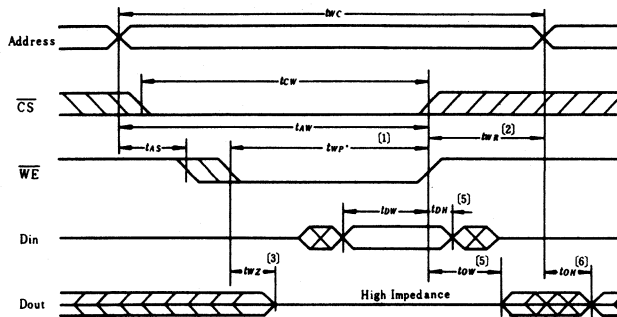

● TIMING WAVEFORM OF WRITE CYCLE NO.2 (\overline{CS} Controlled)

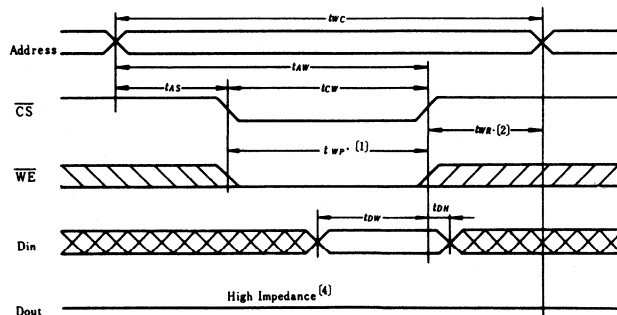

Notes of Timing Waveform of Write :

1. A write occurs during the overlap of the low \overline{CS} and a low \overline{WE} . (t_{WP})
2. t_{WR} is measured from the earlier of \overline{CS} or \overline{WE} going high to the end of write cycle.
3. During this period, I/O pins are in the output state so that the input signals of opposite phase to the outputs must not be applied.
4. If the \overline{CS} low transition occurs simultaneously with the \overline{WE} low transition or after the \overline{WE} transition, the output buffers remain in a high impedance state.
5. If \overline{CS} is low during this period, I/O pins are in the output state. Then the data input signals of opposite phase to the outputs must not be applied to them.
6. Dout is the same phase of write data of this write cycle.

■ LOW V_{CC} DATA RETENTION CHARACTERISTICS ($0^{\circ}\text{C} \leq T_a \leq 70^{\circ}\text{C}$)

Parameter	Symbol	Test Conditions	min	typ	max	Unit
V_{CC} for Data Retention	V_{DR}	$\overline{CS} \geq V_{CC} - 0.2\text{V}$ $V_{iA} \geq V_{CC} - 0.2\text{V}$ or $0\text{V} \leq V_{iA} \leq 0.2\text{V}$	2.0	—	—	V
Data Retention Current	I_{CCDR}		—	—	30* 20**	μA
Chip Deselect to Data Retention Time	t_{CDR}		0	—	—	ns
Operation Recovery Time	t_R		$t_{RC(1)}$	—	—	ns

Note) 1. t_{RC} —Read Cycle Time.

* $V_{CC} = 3.0\text{V}$

** $V_{CC} = 2.0\text{V}$

● LOW V_{CC} DATA RETENTION WAVEFORM

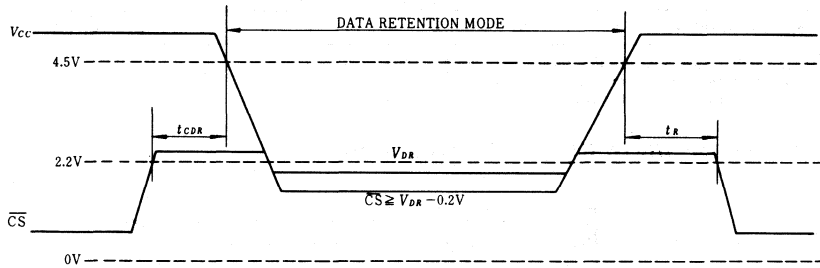

HM6147, HM6147-3 HM6147P, HM6147P-3

4096-word × 1-bit High Speed Static CMOS RAM

FEATURES

- Single 5V Supply and High Density 18 Pin Package
- High Speed: Fast Access Time 55ns/70ns Max.
- Low Power Standby and Low Power Operation, Standby: 100 μ W typ., Operation: 75mW typ.
- Completely Static Memory – No Clock nor Timing Strobe Required
- No Peak Power–On Current
- No Change of t_{ACS} with Short Chip Deselect Time
- Equal Access and Cycle Time
- Directly TTL Compatible – All Input and Output
- Separate Data Input and Output: Three State Output
- Pin-out Compatible with Intel 2147 NMOS STATIC RAM

BLOCK DIAGRAM

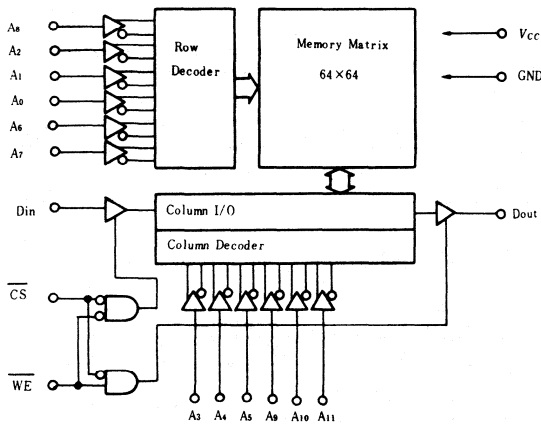

ABSOLUTE MAXIMUM RATINGS

Item	Symbol	Rating	Unit
Voltage on Any Pin relative to GND*	V_T	-0.5 to +7.0	V
Power Dissipation	P_T	1.0	W
Operating Temperature	T_{opr}	0 to +70	°C
Storage Temperature (Ceramic)	T_{stc}	-65 to +150	°C
Storage Temperature (Plastic)	T_{stg}	-55 to +125	°C

* V_{IX} min = -1.0V (Pulse Width \leq 20ns)

RECOMMENDED DC OPERATING CONDITIONS (0°C \leq T_a \leq 70°C)

Parameter	Symbol	min	typ	max	Unit
Supply Voltage	V_{CC}	4.5	5.0	5.5	V
	GND	0	0	0	V
Input High (logic 1) Voltage	V_{IH}	2.2	3.5	6.0	V
Input Low (logic 0) Voltage	V_{IL}	-0.3*	—	0.8	V

* V_{IL} min = -1.0V (Pulse width \leq 20ns)

HM6147, HM6147-3

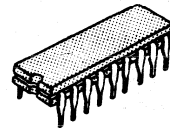

(DG-18)

HM6147P, HM6147P-3



(DP-18)

PIN ARRANGEMENT

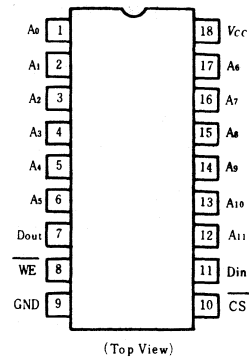

(Top View)

DC AND OPERATING CHARACTERISTICS ($0^{\circ}\text{C} \leq T_a \leq 70^{\circ}\text{C}$, $V_{CC} = 5\text{V} \pm 10\%$, $\text{GND} = 0\text{V}$)

Parameter	Symbol	Test Conditions	min	typ	max	Unit	Notes
Input Leakage Current	$ I_{LI} $	$V_{CC} = 5.5\text{V}$, GND to V_{CC}	—	—	2.0	μA	
Output Leakage Current	$ I_{LO} $	$\overline{\text{CS}} = V_{IH}$, $V_{out} = 0 \sim V_{CC}$	—	—	2.0	μA	
Operating Power Supply Current(1) DC	I_{CC}	$\overline{\text{CS}} = V_{IL}$, Output open	—	15	35	mA	
Operating Power Supply Current(2) DC	I_{CC1}	$\overline{\text{CS}} = V_{IL}$, $V_{IN} \leq 0.2\text{V}$ or $V_{IN} \geq V_{CC} - 0.2\text{V}$	—	12	—	mA	[2]
Average Operating Current(3)	I_{CC2}	Cycle 150ns, duty 50%	—	14	—	mA	[2]
Standby Power Supply Current(1) DC	I_{SB}	$\overline{\text{CS}} = V_{IH}$	—	5	12	mA	
Standby Power Supply Current(2) DC	I_{SB1}	$\overline{\text{CS}} \geq V_{CC} - 0.2\text{V}$, $V_{IN} \leq 0.2\text{V}$ or $V_{IN} \geq V_{CC} - 0.2\text{V}$	—	20	800	μA	
Output Low Voltage	V_{OL}	$I_{OL} = 12\text{mA}$	—	—	0.40	V	
Output High Voltage	V_{OH}	$I_{OH} = -8.0\text{mA}$	2.4	—	—	V	

Note) 1. Typical limits are at $V_{CC} = 5.0\text{V}$, $T_a = 25^{\circ}\text{C}$ and specified loading.
 2. Reference only

AC TEST CONDITIONS

- Input pulse levels: GND to 3.5V
- Input rise and fall times: 10 ns
- Input and output timing reference levels: 1.5V
- Output load: See Figure 1

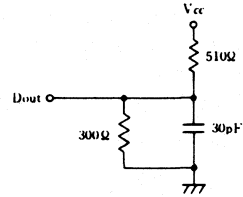

* Including scope & jig capacitance
 Figure 1 Output Load

CAPACITANCE ($T_a = 25^{\circ}\text{C}$, $f = 1.0\text{MHz}$)

Item	Symbol	Conditions	max	Unit
Input Capacitance	C_{in}	$V_{in} = 0\text{V}$	5	pF
Output Capacitance	C_{out}	$V_{out} = 0\text{V}$	7	pF

Note) This parameter is sampled and not 100% tested.

AC CHARACTERISTICS ($T_a = 0^{\circ}\text{C}$ to 70°C , $V_{CC} = 5\text{V} \pm 10\%$, unless otherwise noted.)

READ CYCLE

Parameter	Symbol	HM6147/P-3		HM6147/P		Unit
		min	max	min	max	
Read Cycle Time	t_{RC}	55	—	70	—	ns
Address Access Time	t_{AA}	—	55	—	70	ns
Chip Select Access Time	t_{ACS}	—	55	—	70	ns
Output Hold from Address Change	t_{OH}	5	—	5	—	ns
Chip Selection to Output in Low Z	t_{LZ}	10	—	10	—	ns
Chip Deselection to Output in High Z	t_{HZ}	0	40	0	40	ns
Chip Selection to Power Up Time	t_{PU}	0	—	0	—	ns
Chip Deselection to Power Down Time	t_{PD}	—	30	—	30	ns

WRITE CYCLE

Parameter	Symbol	HM6147/P-3		HM6147/P		Unit
		min	max	min	max	
Write Cycle Time	t_{WC}	55	—	70	—	ns
Chip Selection to End of Write	t_{CW}	45	—	55	—	ns
Address Valid to End of Write	t_{AW}	45	—	55	—	ns
Address Setup Time	t_{AS}	0	—	0	—	ns
Write Pulse Width	t_{WP}	35	—	40	—	ns
Write Recovery Time	t_{WR}	10	—	15	—	ns
Data Valid to End of Write	t_{DW}	25	—	30	—	ns
Data Hold Time	t_{DH}	10	—	10	—	ns
Write Enabled to Output in High Z	t_{WZ}	0	30	0	35	ns
Output Active from End of Write	t_{OW}	0	—	0	—	ns

● TIMING WAVEFORM OF READ CYCLE NO.1 ⁽¹⁾ ⁽²⁾

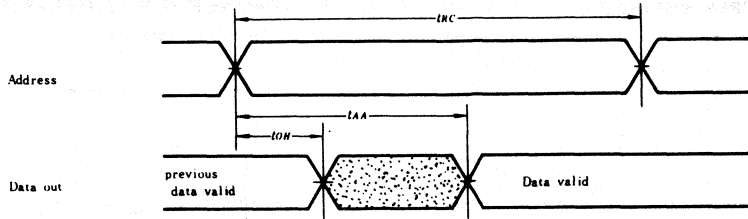

● TIMING WAVEFORM OF READ CYCLE NO.2 ⁽¹⁾ ⁽³⁾

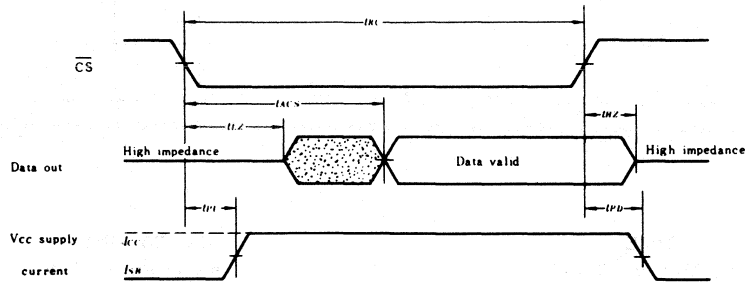

- Notes:
1. \overline{WE} is high for READ Cycle.
 2. \overline{CS} is low for READ Cycle.
 3. Addresses valid prior to or coincident with \overline{CS} transition low.

● TIMING WAVEFORM OF WRITE CYCLE

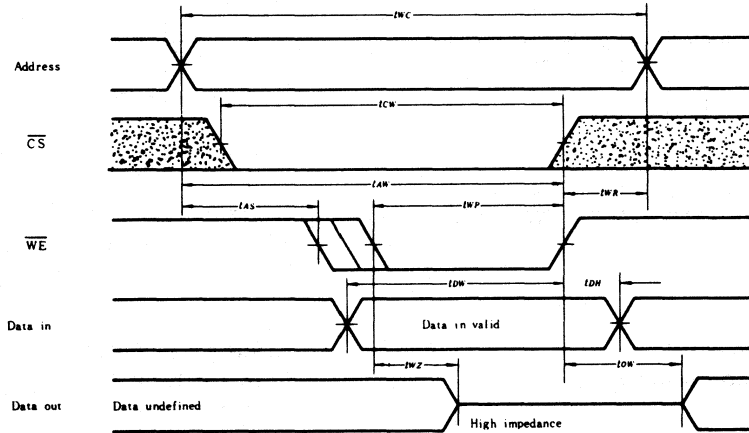

**SUPPLY CURRENT
vs. SUPPLY VOLTAGE**

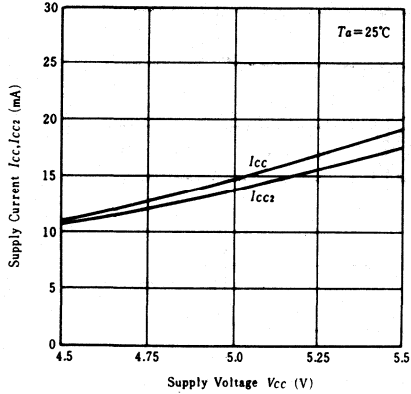

**SUPPLY CURRENT
vs. AMBIENT TEMPERATURE**

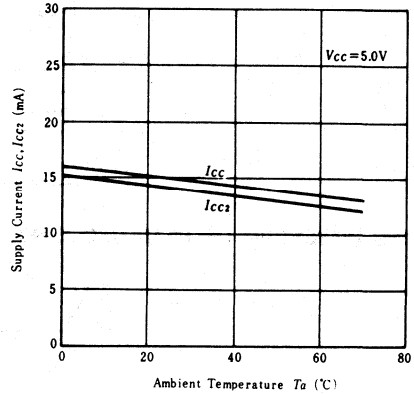

**ACCESS TIME
vs. SUPPLY VOLTAGE**

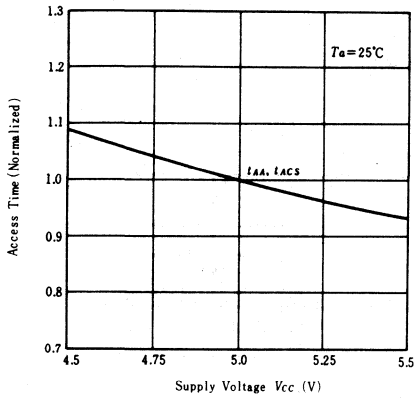

**ACCESS TIME
vs. AMBIENT TEMPERATURE**

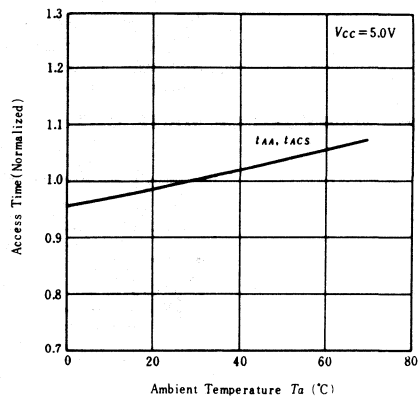

**ACCESS TIME
vs. LOAD CAPACITANCE**

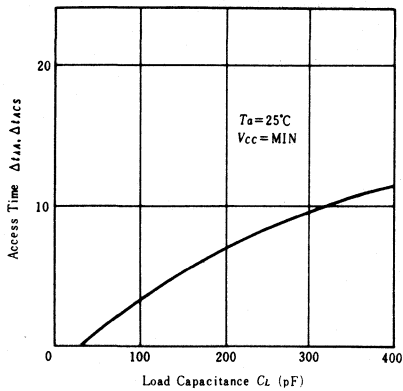

**SUPPLY CURRENT
vs. FREQUENCY**

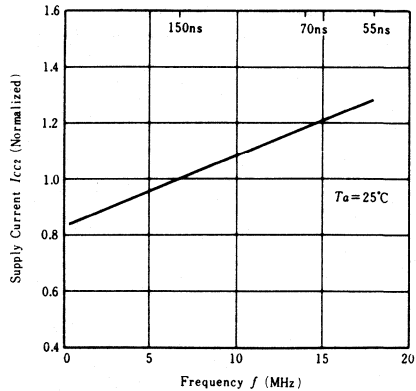

HM6147LP, HM6147LP-3

4096-word × 1-bit High Speed Static CMOS RAM

FEATURES

- Single 5V Supply and High Density 18 Pin Package
- High Speed: Fast Access Time 55ns/70ns Max.
- Low Power Standby and Low Power Operation, Standby: 5μW typ. Operation: 75mW typ.
- Completely Static Memory – No Clock nor Timing Strobe Required
- No Peak Power–On Current
- No Change of t_{ACS} with Short Chip Deselect Time
- Equal Access and Cycle Time
- Directly TTL Compatible – All Input and Output
- Separate Data Input and Output: Three State Output
- Capability of Battery Back up Operation
- Pin-out Compatible with Intel 2147 NMOS STATIC RAM

BLOCK DIAGRAM

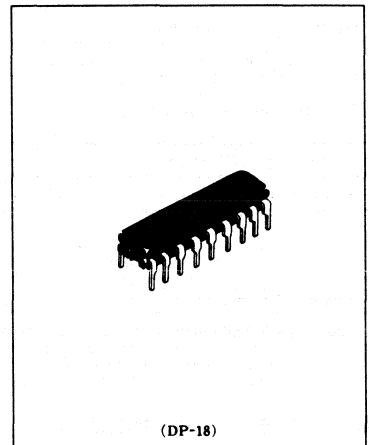
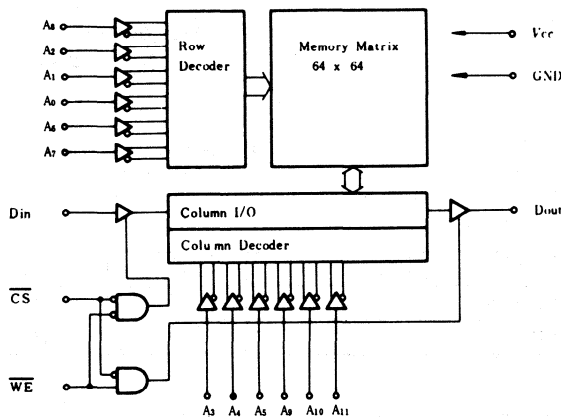

PIN ARRANGEMENT

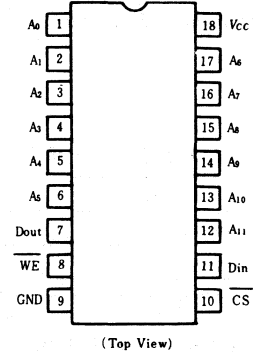

ABSOLUTE MAXIMUM RATINGS

Item	Symbol	Rating	Unit
Voltage on Any Pin relative to GND*	V_T	-0.5 to +7.0	V
Power Dissipation	P_T	1.0	W
Operating Temperature	T_{op}	0 to +70	°C
Storage Temperature	T_{stg}	-55 to +125	°C

* $V_{TL} \text{ min} = -1.0\text{V}$ (Pulse Width $\leq 20\text{ns}$)

RECOMMENDED DC OPERATING CONDITIONS ($0^\circ\text{C} \leq T_a \leq 70^\circ\text{C}$)

Parameter	Symbol	min	typ	max	Unit
Supply Voltage	V_{CC}	4.5	5.0	5.5	V
	GND	0	0	0	V
Input High (logic 1) Voltage	V_{IH}	2.2	3.5	6.0	V
Input Low (logic 0) Voltage	V_{IL}	-0.3*	—	0.8	V

* $V_{IL} \text{ min} = -1.0\text{V}$ (Pulse width $\leq 20\text{ns}$)

DC AND OPERATING CHARACTERISTICS ($0^{\circ}\text{C} \leq T_a \leq 70^{\circ}\text{C}$, $V_{CC} = 5\text{V} \pm 10\%$, $\text{GND} = 0\text{V}$)

Parameter	Symbol	Test Condition	min	typ	max	Unit	Notes
Input Leakage Current	$ I_{LI} $	$V_{CC} = 5.5\text{V}$, GND to V_{CC}	—	—	2.0	μA	
Output Leakage Current	$ I_{LO} $	$\overline{\text{CS}} = V_{IH}$, $V_{out} = 0 \sim V_{CC}$	—	—	2.0	μA	
Operating Power Supply Current(1) DC	I_{CC}	$\overline{\text{CS}} = V_{IL}$, Output open	—	15	35	mA	
Operating Power Supply Current(2) DC	I_{CC1}	$\overline{\text{CS}} = V_{IL}$, $V_{IN} \leq 0.2\text{V}$ or $V_{IN} \geq V_{CC} - 0.2\text{V}$	—	12	—	mA	(2)
Average Operating Current(3)	I_{CC2}	Cycle 150ns, duty 50%	—	14	—	mA	(2)
Standby Power Supply Current(1) DC	I_{SB}	$\overline{\text{CS}} = V_{IH}$	—	5	12	mA	
Standby Power Supply Current(2) DC	I_{SB1}	$\overline{\text{CS}} \geq V_{CC} - 0.2\text{V}$, $V_{IN} \leq 0.2\text{V}$ or $V_{IN} \geq V_{CC} - 0.2\text{V}$	—	1	100	μA	
Output Low Voltage	V_{OL}	$I_{OL} = 12\text{mA}$	—	—	0.40	V	
Output High Voltage	V_{OH}	$I_{OH} = -8.0\text{mA}$	2.4	—	—	V	

Note) 1. Typical limits are at $V_{CC} = 5.0\text{V}$, $T_a = 25^{\circ}\text{C}$ and specified loading.
2. Reference only.

AC TEST CONDITIONS

- Input pulse levels: GND to 3.5V
- Input rise and fall times: 10 ns
- Input and output timing reference levels: 1.5V
- Output load: See Figure 1

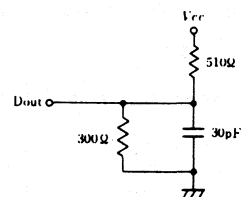

* Including scope & jig capacitance
Figure 1 Output Load

CAPACITANCE ($T_a = 25^{\circ}\text{C}$, $f = 1.0\text{MHz}$)

Item	Symbol	Condition	max	Unit
Input Capacitance	C_{in}	$V_{IN} = 0\text{V}$	5	pF
Output Capacitance	C_{out}	$V_{out} = 0\text{V}$	7	pF

Note) This parameter is sampled and not 100% tested.

AC CHARACTERISTICS ($T_a = 0^{\circ}\text{C}$ to 70°C , $V_{CC} = 5\text{V} \pm 10\%$, unless otherwise noted.)

READ CYCLE

Parameter	Symbol	HM6147LP-3		HM6147LP		Unit
		min	max	min	max	
Read Cycle Time	t_{RC}	55	—	70	—	ns
Address Access Time	t_{AA}	—	55	—	70	ns
Chip Select Access Time	t_{ACS}	—	55	—	70	ns
Output Hold from Address Change	t_{OH}	5	—	5	—	ns
Chip Selection to Output in Low Z	t_{LZ}	10	—	10	—	ns
Chip Deselection to Output in High Z	t_{HZ}	0	40	0	40	ns
Chip Selection to Power Up Time	t_{PU}	0	—	0	—	ns
Chip Deselection to Power Down Time	t_{PD}	—	30	—	30	ns

● WRITE CYCLE

Parameter	Symbol	HM6147LP-3		HM6147LP		Unit
		min	max	min	max	
Write Cycle Time	t_{WC}	55	—	70	—	ns
Chip Selection to End of Write	t_{CW}	45	—	55	—	ns
Address Valid to End of Write	t_{AW}	45	—	55	—	ns
Address Setup Time	t_{AS}	0	—	0	—	ns
Write Pulse Width	t_{WP}	35	—	40	—	ns
Write Recovery Time	t_{WR}	10	—	15	—	ns
Data Valid to End of Write	t_{DW}	25	—	30	—	ns
Data Hold Time	t_{DH}	10	—	10	—	ns
Write Enabled to Output in High Z	t_{WZ}	0	30	0	35	ns
Output Active from End of Write	t_{OW}	0	—	0	—	ns

● TIMING WAVEFORM OF READ CYCLE NO.1⁽¹⁾⁽²⁾

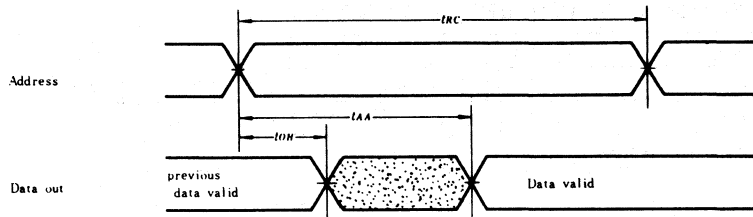

● TIMING WAVEFORM OF READ CYCLE NO.2⁽¹⁾⁽³⁾

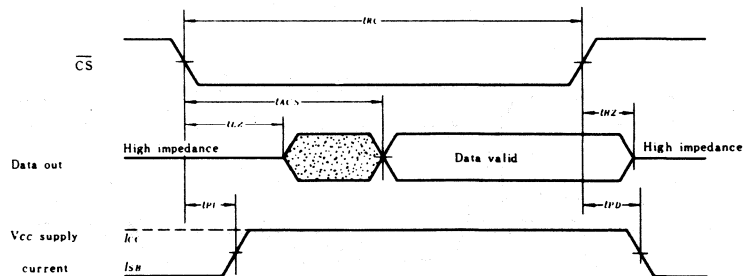

- NOTES: 1. \overline{WE} is high for READ Cycle.
 2. \overline{CS} is low for READ Cycle.
 3. Addresses valid prior to or coincident with \overline{CS} transition low.

● TIMING WAVEFORM OF WRITE CYCLE

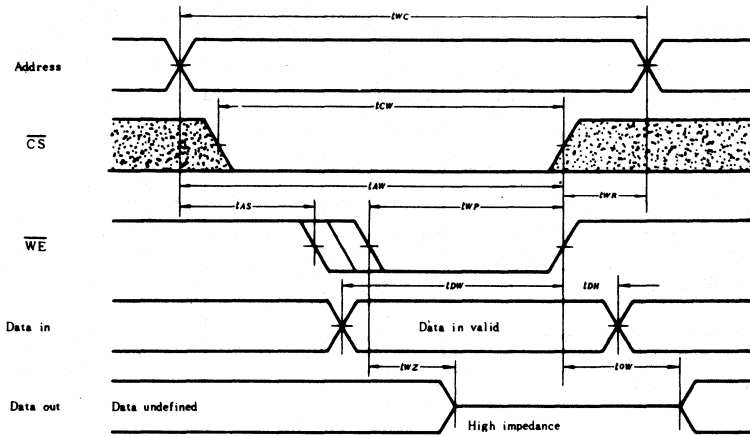

■ LOW V_{CC} RETENTION CHARACTERISTICS ($T_a=0^{\circ}\text{C}$ to 70°C)

Parameter	Symbol	Test Condition	min	typ	max	Unit
V_{CC} for Data Retention	V_{DR}	$\overline{CS} \geq V_{CC} - 0.2\text{V}$, $V_{in} \geq V_{CC} - 0.2\text{V}$ or $\leq 0.2\text{V}$	2.0	—	—	V
Data Retention Current	I_{CCDR}	$V_{CC} = 2.0\text{V}$, $\overline{CS} \geq 1.8\text{V}$, $V_{in} \geq 1.8\text{V}$ or $\leq 0.2\text{V}$	—	—	40	μA
Chip Deselect to Data Retention Time	t_{CDR}		0	—	—	ns
Operation Recovery Time	t_R		t_{RC}^*	—	—	ns

* t_{RC} - Read Cycle Time

● LOW V_{CC} RETENTION CHARACTERISTICS

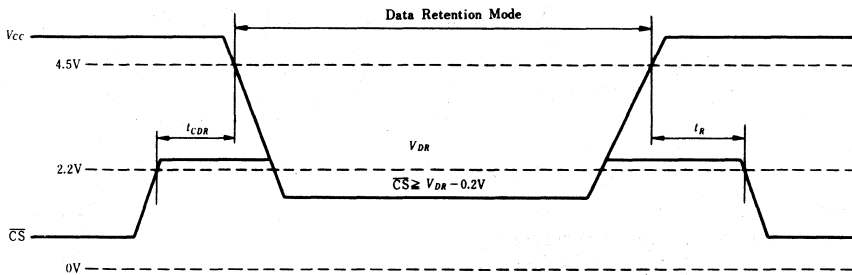

HM6147H-35, HM6147H-45, HM6147H-55, HM6147HP-35, HM6147HP-45, HM6147HP-55

4096-word × 1-bit High Speed Static CMOS RAM

FEATURES

- Single 5V Supply and High Density 18 Pin Package
- High Speed: Fast Access Time 35ns/45ns/55ns Max.
- Low Power Standby and Low Power Operation, Standby: 100 μ W typ., Operation: 150mW typ.
- Completely Static Memory – No Clock nor Timing Strobe Required
- No Peak Power-On Current
- No Change of t_{ACS} with Short Chip Deselect Time
- Equal Access and Cycle Time
- Directly TTL Compatible – All Input and Output
- Separate Data Input and Output: Three State Output
- Plug-In Replacement with Intel 2147H NMOS STATIC RAM

BLOCK DIAGRAM

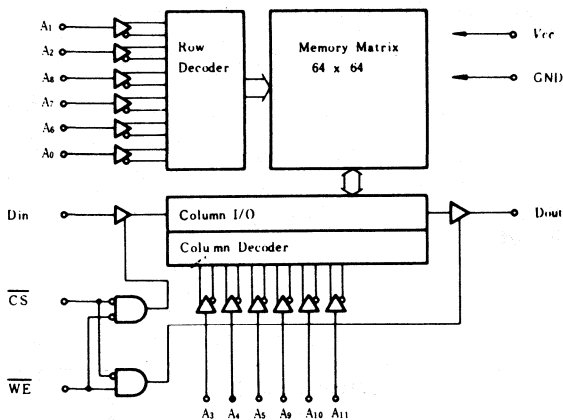

ABSOLUTE MAXIMUM RATINGS

Item	Symbol	Rating	Unit
Voltage on Any Pin relative to GND	V_T	-3.5* to +7.0	V
DC Output Current	I_o	20	mA
Power Dissipation	P_T	1.0	W
Operating Temperature	T_{opr}	0 to +70	°C
Storage Temperature (under bias)	$T_{stg(bias)}$	-10 to +85	°C
Storage Temperature (Ceramic)	T_{stg}	-65 to +150	°C
Storage Temperature (Plastic)	T_{stg}	-55 to +125	°C

* Pulse Width 20ns, DC: -0.5V

HM6147H-35, HM6147H-45,
HM6147H-55

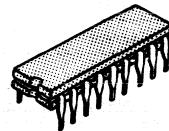

(DG-18)

HM6147HP-35, HM6147HP-45,
HM6147HP-55



(DP-18)

PIN ARRANGEMENT

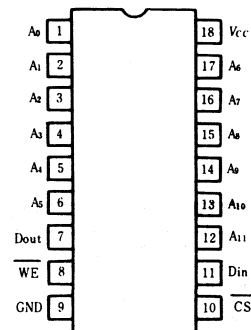

(Top View)

RECOMMENDED DC OPERATING CONDITIONS (0°C ≤ Ta ≤ 70°C)

Parameter	Symbol	min	typ	max	Unit
Supply Voltage	V _{CC}	4.5	5.0	5.5	V
	GND	0	0	0	V
Input High (logic 1) Voltage	V _{IH}	2.0	3.0	6.0	V
Input Low (logic 0) Voltage	V _{IL}	-3.0*	—	0.8	V

* Pulse Width 20ns, DC: -0.5V

DC AND OPERATING CHARACTERISTICS (0°C ≤ Ta ≤ 70°C, V_{CC} = 5V ± 10%, GND = 0V)

Parameter	Symbol	Test Condition	min	typ	max	Unit
Input Leakage Current	I _{LI}	V _{CC} = 5.5V, GND to V _{CC}	—	—	10	μA
Output Leakage Current	I _{LO}	$\overline{CS} = V_{IH}$, V _{out} = 0V ~ V _{CC}	—	—	10	μA
Operating Power Supply Current(1) DC	I _{CC}	$\overline{CS} = V_{IL}$, Output open	—	30	80	mA
Operating Power Supply Current(2) DC	I _{CC1}	$\overline{CS} = V_{IL}$, Minimum Cycle	—	40	80	mA
Standby Power Supply Current(1) DC	I _{SB}	$\overline{CS} = V_{IH}$, V _{CC} = Min to Max	—	8	20	mA
Standby Power Supply Current(2) DC	I _{SB1}	$\overline{CS} \geq V_{CC} - 0.2V$, V _{IN} ≤ 0.2V or V _{IN} ≥ V _{CC} - 0.2V	—	20	800	μA
Output Low Voltage	V _{OL}	I _{OL} = 8mA	—	—	0.40	V
Output High Voltage	V _{OH}	I _{OH} = -4mA	2.4	—	—	V

Note) 1. The operating ambient temperature range is guaranteed with transverse air flow exceeding 400 linear feet minute.
2. Typical limits are at V_{CC} = 5.0V, Ta = 25°C and specified loading.

AC TEST CONDITIONS

- Input pulse levels: GND to 3.0V
- Input rise and fall times: 5 ns
- Input timing reference levels: 1.5V
- Output load: See Figure
- Output timing reference levels: 1.5V (HM6147H/P-35)
0.8 to 2.0V (HM6147H/P-45/55)

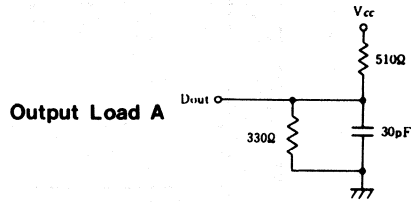

* Including scope & jig capacitance

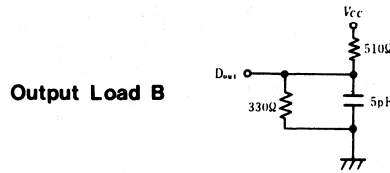

CAPACITANCE (Ta = 25°C, f = 1.0MHz)

Item	Symbol	Conditions	max	Unit
Input Capacitance	C _{in}	V _{in} = 0V	5	pF
Output Capacitance	C _{out}	V _{out} = 0V	6	pF

Note) This parameter is sampled and not 100% tested.

■ AC CHARACTERISTICS ($T_a = 0^\circ\text{C}$ to 70°C , $V_{CC} = 5\text{V} \pm 10\%$, unless otherwise noted.)

● READ CYCLE

Parameter	Symbol	HM6147H/P-35		HM6147H/P-45		HM6147H/P-55		Unit	Notes
		min	max	min	max	min	max		
Read Cycle Time	t_{RC}	35	—	45	—	55	—	ns	(1)
Address Access Time	t_{AA}	—	35	—	45	—	55	ns	
Chip Select Access Time	t_{ACS}	—	35	—	45	—	55	ns	
Output Hold from Address Change	t_{OH}	5	—	5	—	5	—	ns	
Chip Selection to Output in Low Z	t_{LZ}	5	—	5	—	5	—	ns	(2), (3), (7)
Chip Deselection to Output in High Z	t_{HZ}	0	30	0	30	0	30	ns	(2), (3), (7)
Chip Selection to Power Up Time	t_{PU}	0	—	0	—	0	—	ns	
Chip Deselection to Power Down Time	t_{PD}	—	20	—	20	—	20	ns	

● TIMING WAVEFORM OF READ CYCLE NO.1 ⁽⁴⁾ ⁽⁵⁾

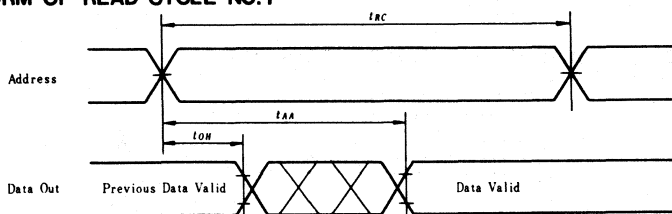

● TIMING WAVEFORM OF READ CYCLE NO.2 ⁽⁴⁾ ⁽⁶⁾

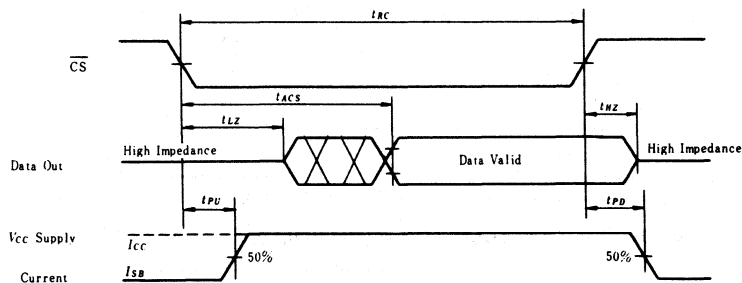

- Notes:
1. All Read Cycle timings are referenced from last valid address to the first transitioning address.
 2. At any given temperature and voltage condition, t_{HZ} max. is less than t_{LZ} min. both for a given device and from device to device.
 3. Transition is measured $\pm 500\text{mV}$ from steady state voltage with specified loading in Load B.
 4. WE is high for READ Cycle.
 5. Device is continuously selected, $\overline{\text{CS}} = V_{IL}$.
 6. Addresses valid prior to or coincident with $\overline{\text{CS}}$ transition low.
 7. This parameter is sampled and not 100% tested.

● WRITE CYCLE

Parameter	Symbol	HM6147H/P-35		HM6147H/P-45		HM6147H/P-55		Unit	Notes
		min	max	min	max	min	max		
Write Cycle Time	t_{wc}	35	—	45	—	55	—	ns	(2)
Chip Selection to End of Write	t_{cw}	35	—	45	—	45	—	ns	
Address Valid to End of Write	t_{aw}	35	—	45	—	45	—	ns	
Address Setup Time	t_{as}	0	—	0	—	0	—	ns	
Write Pulse Width	t_{wp}	20	—	25	—	30	—	ns	
Write Recovery Time	t_{wr}	0	—	0	—	0	—	ns	
Data Valid to End of Write	t_{dw}	20	—	25	—	25	—	ns	
Data Hold Time	t_{dh}	10	—	10	—	10	—	ns	
Write Enabled to Output in High Z	t_{wz}	0	20	0	25	0	30	ns	(3), (4)
Output Active from End of Write	t_{ow}	0	—	0	—	0	—	ns	(3), (4)

● TIMING WAVEFORM OF WRITE CYCLE (\overline{WE} CONTROLLED)

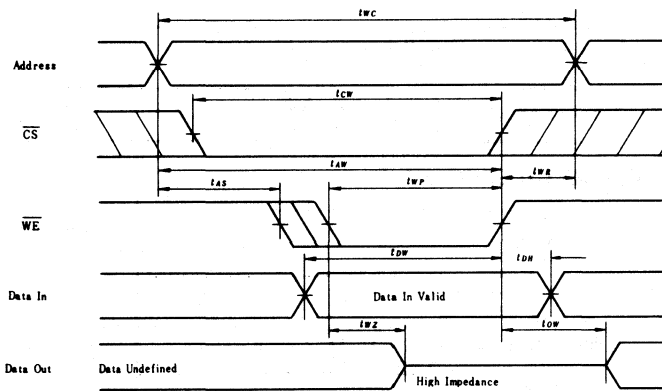

● TIMING WAVEFORM OF WRITE CYCLE (\overline{CS} CONTROLLED)

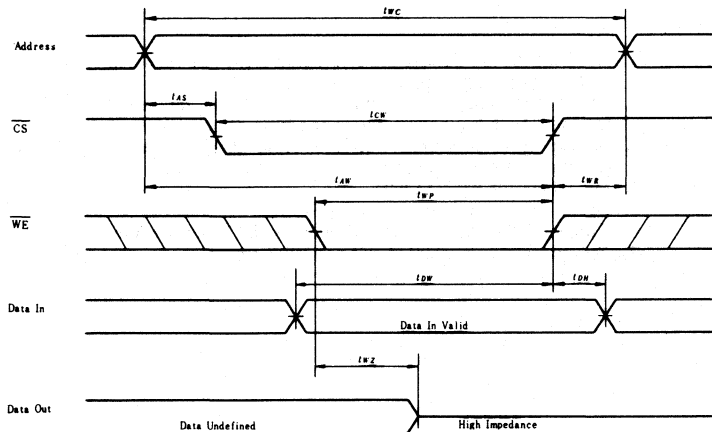

Note) \overline{CS} or \overline{WE} are High for Address Transition

- Notes:
1. If \overline{CS} goes high simultaneously with \overline{WE} high, the output remains in a high impedance states.
 2. All Write Cycle timings are referenced from the last valid address to the first transitioning address.
 3. Transition is measured $\pm 500\text{mV}$ from steady state voltage with specified loading in Load B.
 4. This parameter is sampled and not 100% tested.

ACCESS TIME VS. SUPPLY VOLTAGE

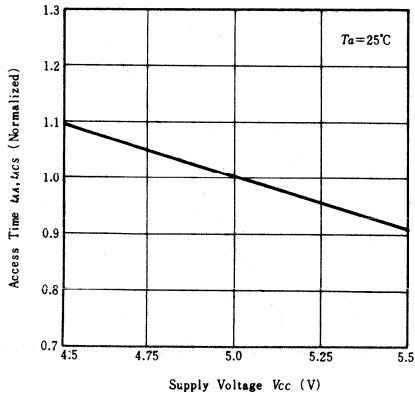

ACCESS TIME VS. AMBIENT TEMPERATURE

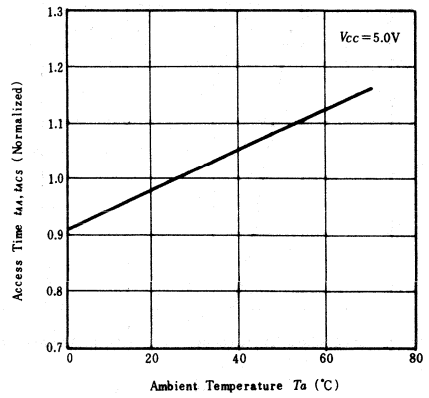

ACCESS TIME VS. LOAD CAPACITANCE

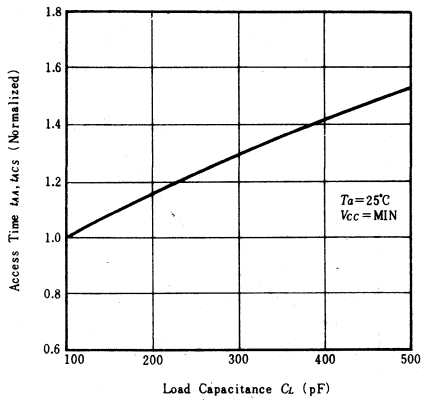

SUPPLY CURRENT VS. FREQUENCY

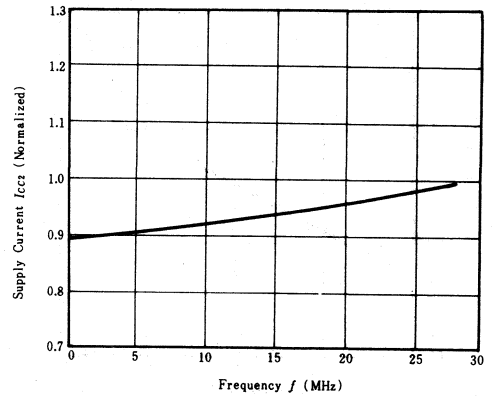

INPUT LOW VOLTAGE VS. SUPPLY VOLTAGE

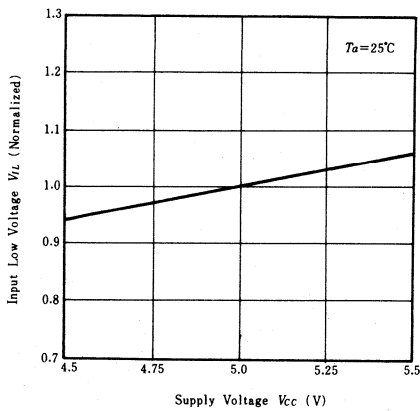

INPUT HIGH VOLTAGE VS. SUPPLY VOLTAGE

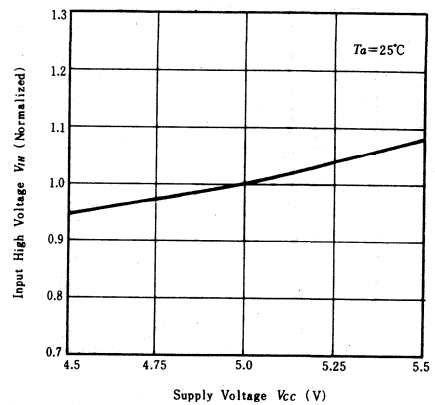

OUTPUT CURRENT VS. OUTPUT VOLTAGE

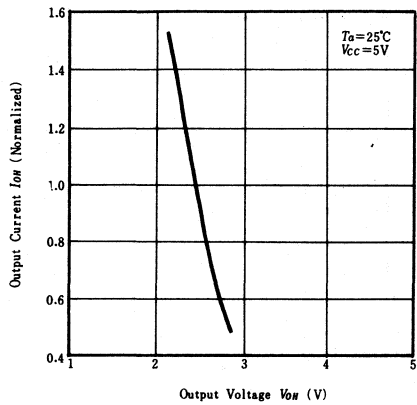

OUTPUT CURRENT VS. OUTPUT VOLTAGE

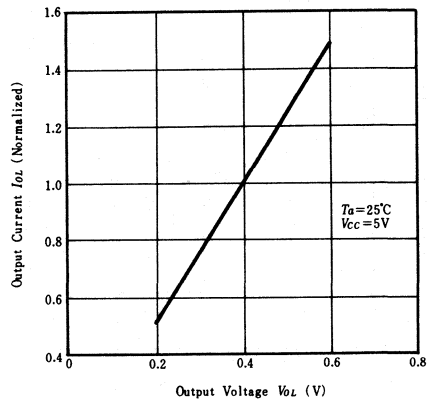

STANDBY CURRENT VS. AMBIENT TEMPERATURE

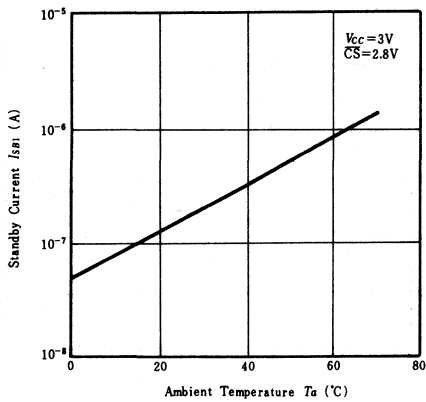

STANDBY CURRENT VS. SUPPLY VOLTAGE

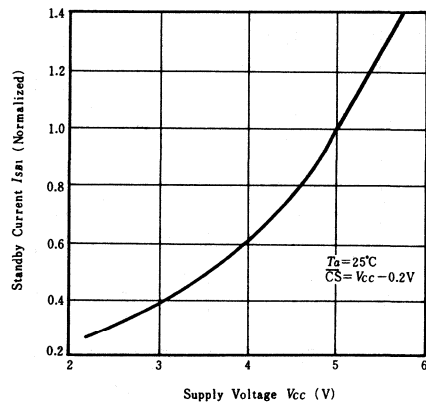

STANDBY CURRENT VS. INPUT VOLTAGE

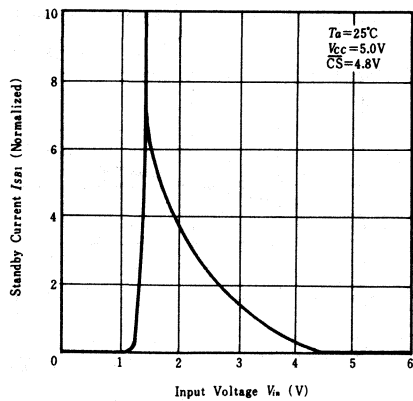

HM6147HLP-35, HM6147HLP-45, HM6147HLP-55

4096-word × 1-bit High Speed Static CMOS RAM

FEATURES

- Single 5V Supply and High Density 18 Pin Package
- High Speed: Fast Access Time 35ns/45ns/55ns Max.
- Low Power Standby and Low Power Operation, Standby: 5μW typ., Operation: 150mW typ.
- Completely Static Memory – No Clock nor Timing Strobe Required
- No Peak Power–On Current
- No Change of t_{ACS} with Short Chip Deselect Time
- Equal Access and Cycle Time
- Directly TTL Compatible – All Input and Output
- Separate Data Input and Output: Three State Output
- Plug-In Replacement with Intel 2147H NMOS STATIC RAM
- Capable of Battery Back up Operation

BLOCK DIAGRAM

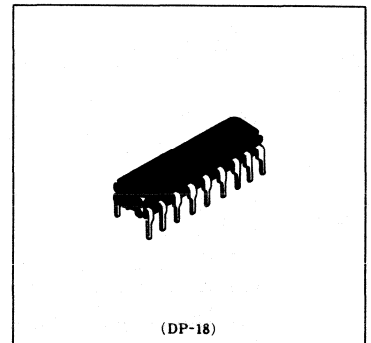
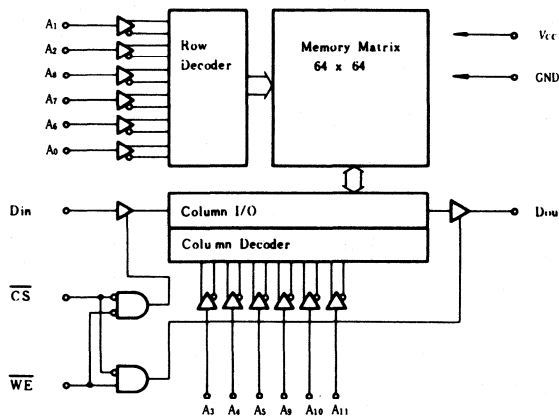

PIN ARRANGEMENT

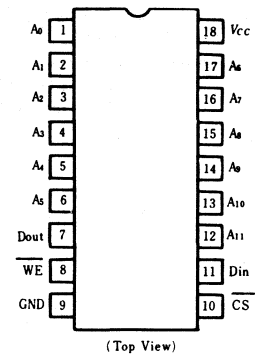

ABSOLUTE MAXIMUM RATINGS

Item	Symbol	Rating	Unit
Voltage on Any Pin relative to GND	V_T	-3.5* to +7.0	V
DC Output Current	I_O	20	mA
Power Dissipation	P_T	1.0	W
Operating Temperature	T_{opr}	0 to +70	°C
Storage Temperature (under bias)	$T_{stg(bias)}$	-10 to +85	°C
Storage Temperature	T_{stg}	-55 to +125	°C

* Pulse Width 20ns. DC: -0.5V

RECOMMENDED DC OPERATING CONDITIONS (0°C ≤ Ta ≤ 70°C)

Parameter	Symbol	min	typ	max	Unit
Supply Voltage	V_{CC}	4.5	5.0	5.5	V
	GND	0	0	0	V
Input High (logic 1) Voltage	V_{IH}	2.2	3.0	6.0	V
Input Low (logic 0) Voltage	V_{IL}	-0.5*	—	0.8	V

* V_{IL} min = -3V (Pulse width ≤ 20ns)

■ DC AND OPERATING CHARACTERISTICS ($0^{\circ}\text{C} \leq T_a \leq 70^{\circ}\text{C}$, $V_{CC} = 5\text{V} \pm 10\%$, $\text{GND} = 0\text{V}$)

Parameter	Symbol	Test Condition	min	typ	max	Unit
Input Leakage Current	$ I_{LI} $	$V_{CC} = 5.5\text{V}$, GND to V_{CC}	—	—	10	μA
Output Leakage Current	$ I_{LO} $	$\overline{\text{CS}} = V_{IH}$, $V_{out} = 0\text{V} \sim V_{CC}$	—	—	10	μA
Operating Power Supply Current(1) DC	I_{CC}	$\overline{\text{CS}} = V_{IL}$, Output open	—	30	80	mA
Operating Power Supply Current(2) DC	I_{CC1}	$\overline{\text{CS}} = V_{IL}$, Minimum Cycle	—	40	80	mA
Standby Power Supply Current(1) DC	I_{SB}	$\overline{\text{CS}} = V_{IH}$, $V_{CC} = \text{Min to Max}$	—	5	15	mA
Standby Power Supply Current(2) DC	I_{SB1}	$\overline{\text{CS}} \geq V_{CC} - 0.2\text{V}$, $V_{IN} \leq 0.2\text{V}$ or $V_{IN} \geq V_{CC} - 0.2\text{V}$	—	1	100	μA
Output Low Voltage	V_{OL}	$I_{OL} = 8\text{mA}$	—	—	0.40	V
Output High Voltage	V_{OH}	$I_{OH} = -4.0\text{mA}$	2.4	—	—	V

Note) 1. The operating ambient temperature range is guaranteed with transverse air flow exceeding 400 linear feet per minute.
2. Typical limits are at $V_{CC} = 5.0\text{V}$, $T_a = 25^{\circ}\text{C}$ and specified loading.

■ AC TEST CONDITIONS

- Input pulse levels: GND to 3.0V
- Input rise and fall times: 5 ns
- Input timing reference levels: 1.5V
- Output load: See Figure
- Output timing reference levels:
1.5V (HM6147HLP-35)
0.8 to 2.0V (HM6147HLP-45/55)

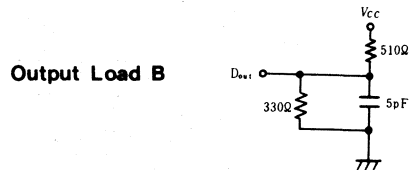
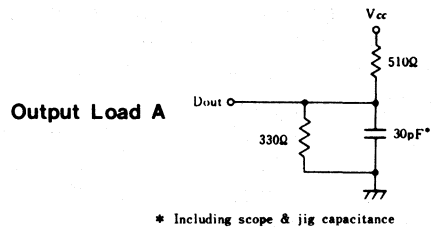

■ CAPACITANCE ($T_a = 25^{\circ}\text{C}$, $f = 1.0\text{MHz}$)

Item	Symbol	Conditions	max	Unit
Input Capacitance	C_{in}	$V_{in} = 0\text{V}$	5	pF
Output Capacitance	C_{out}	$V_{out} = 0\text{V}$	6	pF

Note) This parameter is sampled and not 100% tested.

■ AC CHARACTERISTICS ($T_a = 0^{\circ}\text{C}$ to 70°C , $V_{CC} = 5\text{V} \pm 10\%$, unless otherwise noted.)

● READ CYCLE

Parameter	Symbol	HM6147HLP-35		HM6147HLP-45		HM6147HLP-55		Unit	Notes
		min	max	min	max	min	max		
Read Cycle Time	t_{RC}	35	—	45	—	55	—	ns	(1)
Address Access Time	t_{AA}	—	35	—	45	—	55	ns	
Chip Select Access Time	t_{ACS}	—	35	—	45	—	55	ns	
Output Hold from Address Change	t_{OH}	5	—	5	—	5	—	ns	
Chip Selection to Output in Low Z	t_{LZ}	5	—	5	—	5	—	ns	(2), (3), (7)
Chip Deselection to Output in High Z	t_{HZ}	0	30	0	30	0	30	ns	(2), (3), (7)
Chip Selection to Power Up Time	t_{PU}	0	—	0	—	0	—	ns	
Chip Deselection to Power Down Time	t_{PD}	—	20	—	20	—	20	ns	

● TIMING WAVEFORM OF READ CYCLE NO.1 (4) (5)

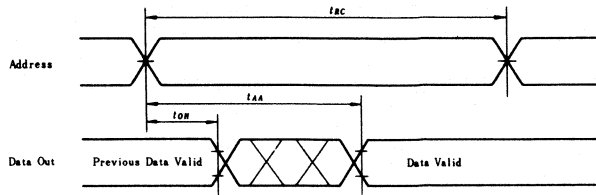

● TIMING WAVEFORM OF READ CYCLE NO.2 (4) (6)

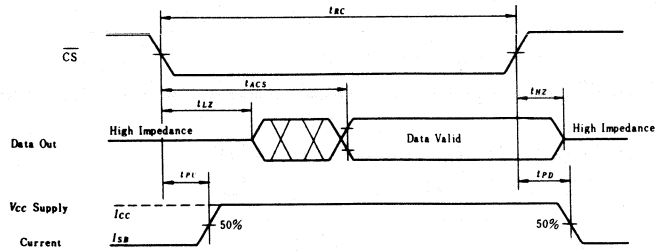

- Notes:
1. All Read Cycle timings are referenced from last valid address to the first transitioning address.
 2. At any given temperature and voltage condition, t_{HZ} max. is less than t_{LZ} min. both for a given device and from device to device.
 3. Transition is measured $\pm 500\text{mV}$ from steady state voltage with specified loading in Load B.
 4. \overline{WE} is high for READ Cycle.
 5. Device is continuously selected, $\overline{CS} = V_{IL}$.
 6. Addresses valid prior to or coincident with \overline{CS} transition low.
 7. This parameter is sampled and not 100% tested.

● WRITE CYCLE

Parameter	Symbol	HM6147HLP-35		HM6147HLP-45		HM6147HLP-55		Unit	Notes
		min	max	min	max	min	max		
Write Cycle Time	t_{WC}	35	—	45	—	55	—	ns	[2]
Chip Selection to End of Write	t_{CW}	35	—	45	—	45	—	ns	
Address Valid to End of Write	t_{AW}	35	—	45	—	45	—	ns	
Address Setup Time	t_{AS}	0	—	0	—	0	—	ns	
Write Pulse Width	t_{WP}	20	—	25	—	30	—	ns	
Write Recovery Time	t_{WR}	0	—	0	—	0	—	ns	
Data Valid to End of Write	t_{DW}	20	—	25	—	25	—	ns	
Data Hold Time	t_{DH}	10	—	10	—	10	—	ns	
Write Enable to Output in High Z	t_{WZ}	0	20	0	25	0	30	ns	[3], [4]
Output Active from End of Write	t_{OW}	0	—	0	—	0	—	ns	[3], [4]

● TIMING WAVEFORM OF WRITE CYCLE (\overline{WE} CONTROLLED)

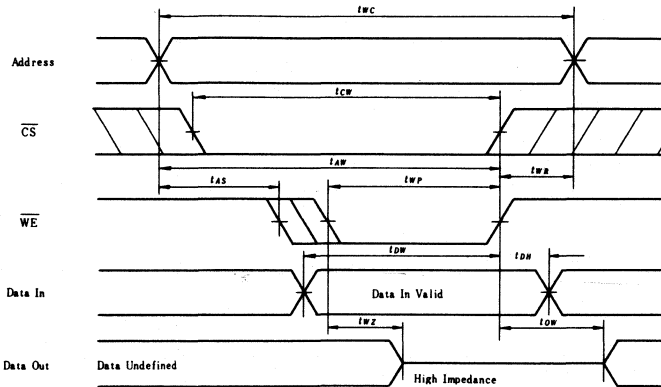

● TIMING WAVEFORM OF WRITE CYCLE (\overline{CS} CONTROLLED)

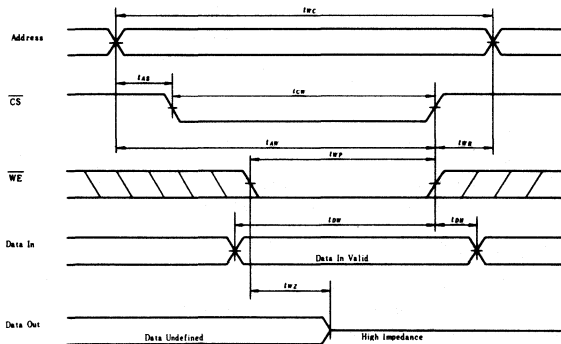

- Notes: 1. If \overline{CS} goes high simultaneously with \overline{WE} high, the output remains in a high impedance states.
 2. All Write Cycle timings are referenced from the last valid address to the first transitioning address.
 3. Transition is measured $\pm 500\text{mV}$ from steady state voltage with specified loading in Load B.
 4. This parameter is sampled and not 100% tested.

■ LOW V_{CC} DATA RETENTION CHARACTERISTICS ($T_a = 0^\circ\text{C}$ to $+70^\circ\text{C}$)

Item	Symbol	Test Condition	min	typ	max	Unit
V_{CC} for Data Retention	V_{DR}	$\overline{CS} \geq V_{CC} - 0.2\text{V}$ $V_{IN} \geq V_{CC} - 0.2\text{V}$ or $V_{IN} \leq 0.2\text{V}$	2.0	—	—	V
Data Retention Current	I_{CCDR}	$V_{CC} = 3.0\text{V}$, $\overline{CS} \geq 2.8\text{V}$ $V_{IN} \geq 2.8\text{V}$ or $V_{IN} \leq 0.2\text{V}$	—	—	50	μA
Chip Deselect to Data Retention Time	t_{CDR}	See Retention Waveform	0	—	—	ns
Operation Recovery Time	t_R		t_{RC}^*	—	—	ns

* t_{RC} - Read Cycle Time.

● LOW V_{CC} DATA RETENTION WAVEFORM

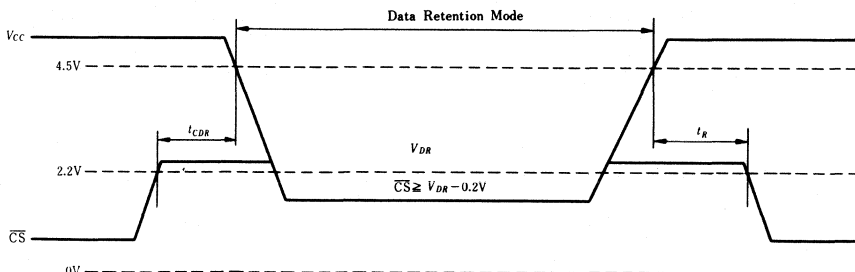

HM6116-2, HM6116-3, HM6116-4 HM6116P-2, HM6116P-3, HM6116P-4

2048-word × 8-bit High Speed Static CMOS RAM

FEATURES

- Single 5V Supply and High Density 24 Pin Package
- High speed: Fast Access Time 120ns/150ns/200ns (max.)
- Low Power Standby and Standby: 100μW (typ.)
- Low Power Operation Operation: 180mW (typ.)
- Completely Static RAM: No clock or Timing Strobe Required
- Directly TTL Compatible: All Input and Output
- Pin Out Compatible with Standard 16K EPROM/MASK ROM
- Equal Access and Cycle Time

FUNCTIONAL BLOCK DIAGRAM

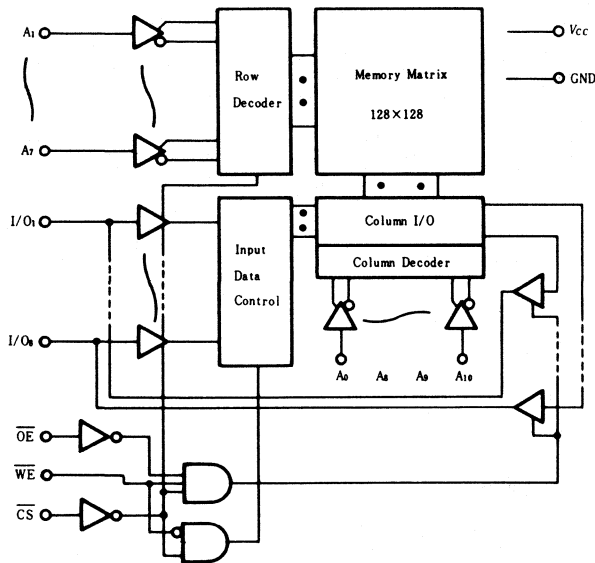

ABSOLUTE MAXIMUM RATINGS

Item	Symbol	Rating	Unit
Voltage on Any Pin Relative to GND	V_T	-0.5* to +7.0	V
Operating Temperature	T_{opr}	0 to +70	°C
Storage Temperature (Plastic)	T_{stg}	-55 to +125	°C
Storage Temperature (Ceramic)	T_{stg}	-65 to +150	°C
Temperature Under Bias	T_{bias}	-10 to +85	°C
Power Dissipation	P_T	1.0	W

* Pulse Width 50ns : -1.5 V

TRUTH TABLE

CS	OE	WE	Mode	V_{cc} Current	I/O Pin	Ref. Cycle
H	×	×	Not Selected	I_{SB}, I_{SB1}	High Z	
L	L	H	Read	I_{cc}	Dout	Read Cycle (1)~(3)
L	H	L	Write	I_{cc}	Din	Write Cycle (1)
L	L	L	Write	I_{cc}	Din	Write Cycle (2)

HM6116-2, HM6116-3,
HM6116-4

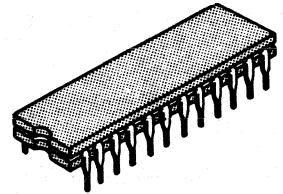

(DG-24)

HM6116P-2, HM6116P-3,
HM6116P-4

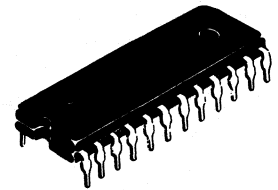

(DP-24)

PIN ARRANGEMENT

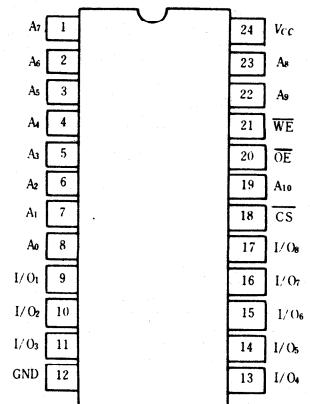

(Top View)

■ RECOMMENDED DC OPERATING CONDITIONS (Ta=0 to +70°C)

Item	Symbol	min	typ	max	Unit
Supply Voltage	V _{CC}	4.5	5.0	5.5	V
	GND	0	0	0	V
Input Voltage	V _{IH}	2.2	3.5	6.0	V
	V _{IL}	-1.0*	—	0.8	V

* Pulse Width : 50ns, DC : V_{IL} min = -0.3V

■ DC AND OPERATING CHARACTERISTICS (V_{CC}=5V±10%, GND=0V, Ta=0 to +70°C)

Item	Symbol	Test Conditions	HM6116/P-2			HM6116/P-3/-4			Unit
			min	typ*	max	min	typ*	max	
Input Leakage Current	I _{LI}	V _{CC} =5.5V, V _{IN} =GND to V _{CC}	—	—	10	—	—	10	μA
Output Leakage Current	I _{LO}	$\overline{CS} = V_{IH}$ or $\overline{OE} = V_{IH}$, V _{I/O} =GND to V _{CC}	—	—	10	—	—	10	μA
Operating Power Supply Current	I _{CC}	$\overline{CS} = V_{IL}$, I _{I/O} =0mA	—	40	80	—	35	70	mA
	I _{CC1} **	V _{IH} =3.5V, V _{IL} =0.6V, I _{I/O} =0mA	—	35	—	—	30	—	mA
Average Operating Current	I _{CCZ}	Min. cycle, duty=100%	—	40	80	—	35	70	mA
Standby Power Supply Current	I _{SB}	$\overline{CS} = V_{IH}$	—	5	15	—	5	15	mA
	I _{SB1}	$\overline{CS} \geq V_{CC} - 0.2V$, V _{IN} ≥ V _{CC} -0.2V or V _{IN} ≤ 0.2V	—	0.02	2	—	0.02	2	mA
Output Voltage	V _{OL}	I _{OL} =4mA	—	—	0.4	—	—	—	V
		I _{OL} =2.1mA	—	—	—	—	—	0.4	V
	V _{OH}	I _{OH} =-1.0mA	2.4	—	—	2.4	—	—	V

* V_{CC}=5V, Ta=25°C

** Reference Only

■ AC CHARACTERISTICS (V_{CC}=5V±10%, Ta=0 to +70°C)

● AC TEST CONDITIONS

Input Pulse Levels: 0.8 to 2.4V

Input Rise and Fall Times: 10 ns

Input and Output Timing Reference Levels: 1.5V

Output Load: 1TTL Gate and C_L = 100pF (including scope and jig)

● READ CYCLE

Item	Symbol	HM6116/P-2		HM6116/P-3		HM6116/P-4		Unit
		min	max	min	max	min	max	
Read Cycle Time	t _{RC}	120	—	150	—	200	—	ns
Address Access Time	t _{AA}	—	120	—	150	—	200	ns
Chip Select Access Time	t _{ACS}	—	120	—	150	—	200	ns
Chip Selection to Output in Low Z	t _{CLZ}	10	—	15	—	15	—	ns
Output Enable to Output Valid	t _{OE}	—	80	—	100	—	120	ns
Output Enable to Output in Low Z	t _{OLZ}	10	—	15	—	15	—	ns
Chip Deselection to Output in High Z	t _{CHZ}	0	40	0	50	0	60	ns
Chip Disable to Output in High Z	t _{ONZ}	0	40	0	50	0	60	ns
Output Hold from Address Change	t _{OH}	10	—	15	—	15	—	ns

● WRITE CYCLE

Item	Symbol	HM6116/P-2		HM6116/P-3		HM6116/P-4		Unit
		min	max	min	max	min	max	
Write Cycle Time	t_{WC}	120	—	150	—	200	—	ns
Chip Selection to End of Write	t_{CW}	70	—	90	—	120	—	ns
Address Valid to End of Write	t_{AW}	105	—	120	—	140	—	ns
Address Set Up Time	t_{AS}	20	—	20	—	20	—	ns
Write Pulse Width	t_{WP}	70	—	90	—	120	—	ns
Write Recovery Time	t_{WR}	5	—	10	—	10	—	ns
Output Disable to Output in High Z	t_{OHZ}	0	40	0	50	0	60	ns
Write to Output in High Z	t_{WHZ}	0	50	0	60	0	60	ns
Data to Write Time Overlap	t_{DW}	35	—	40	—	60	—	ns
Data Hold from Write Time	t_{DH}	5	—	10	—	10	—	ns
Output Active from End of Write	t_{OW}	5	—	10	—	10	—	ns

■ CAPACITANCE ($f=1\text{MHz}$, $T_a=25^\circ\text{C}$)

Item	Symbol	Test Conditions	typ	max	Unit
Input Capacitance	$C_{i\alpha}$	$V_{i\alpha}=0\text{V}$	3	5	pF
Input/Output Capacitance	C_{LO}	$V_{LO}=0\text{V}$	5	7	pF

Note) This parameter is sampled and not 100% tested.

■ TIMING WAVEFORM

● READ CYCLE (1)⁽¹⁾

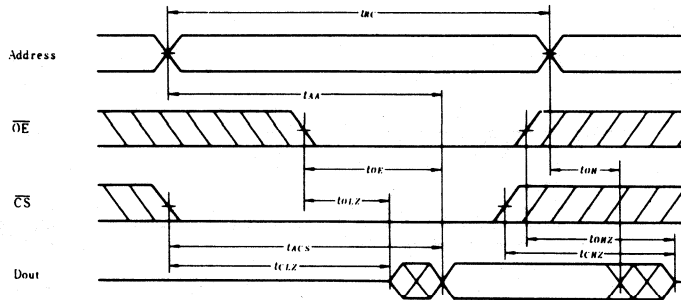

● READ CYCLE (2)⁽¹⁾⁽²⁾⁽⁴⁾

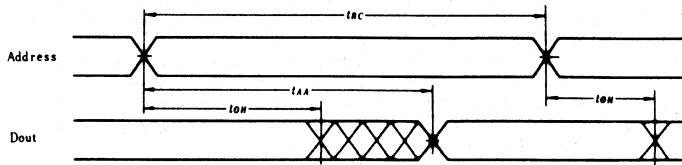

● READ CYCLE (3)⁽¹⁾⁽³⁾⁽⁴⁾

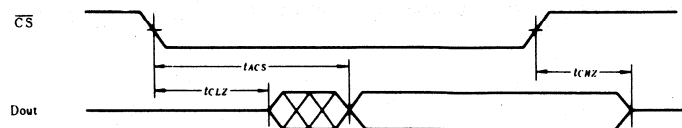

- NOTES: 1. WE is High for Read Cycle.
 2. Device is continuously selected, $\overline{CS} = V_{IL}$.
 3. Address Valid prior to or coincident with CS transition Low.
 4. $\overline{OE} = V_{IL}$.

WRITE CYCLE (1)

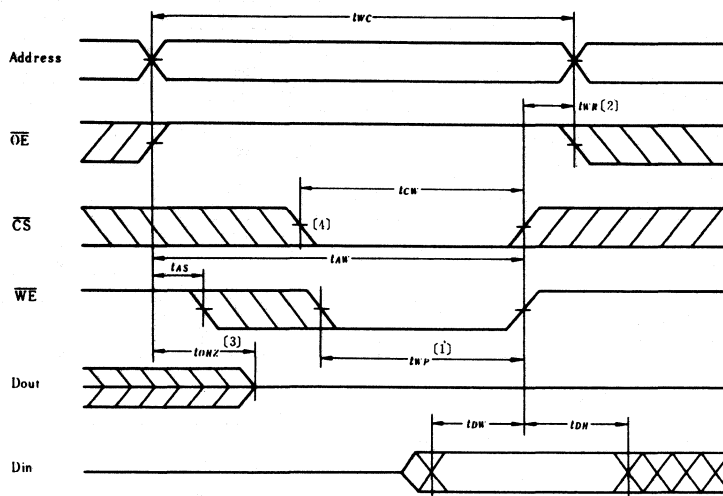

● WRITE CYCLE (2) ⁽⁵⁾

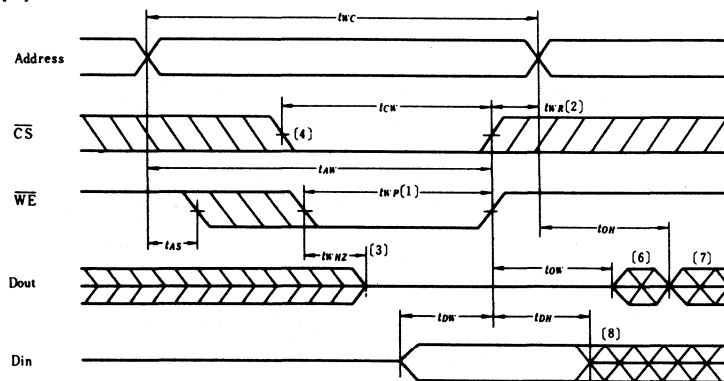

- NOTES:**
1. A write occurs during the overlap (t_{WP}) of a low \overline{CS} and a low \overline{WE} .
 2. t_{WR} is measured from the earlier of \overline{CS} or \overline{WE} going high to the end of write cycle.
 3. During this period, I/O pins are in the output state so that the input signals of opposite phase to the outputs must not be applied.
 4. If the \overline{CS} low transition occurs simultaneously with the \overline{WE} low transitions or after the \overline{WE} transition, output remain in a high impedance state.
 5. \overline{OE} is continuously low. ($\overline{OE} = V_{IL}$)
 6. D_{out} is the same phase of write data of this write cycle.
 7. D_{out} is the read data of next address.
 8. If \overline{CS} is Low during this period, I/O pins are in the output state. Then the data input signals of opposite phase to the outputs must not be applied to them.

**SUPPLY CURRENT
vs. SUPPLY VOLTAGE**

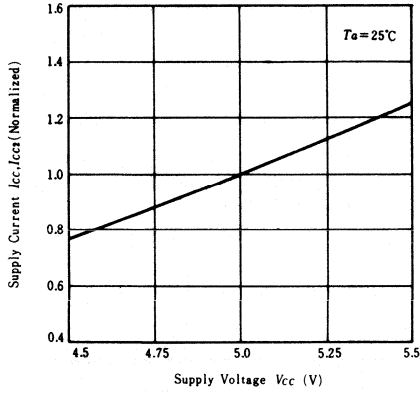

**SUPPLY CURRENT
vs. AMBIENT TEMPERATURE**

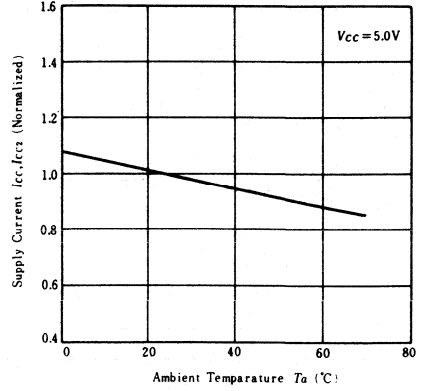

**ACCESS TIME
vs. SUPPLY VOLTAGE**

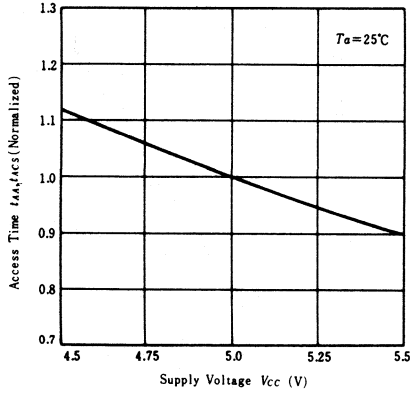

**ACCESS TIME
vs. AMBIENT TEMPERATURE**

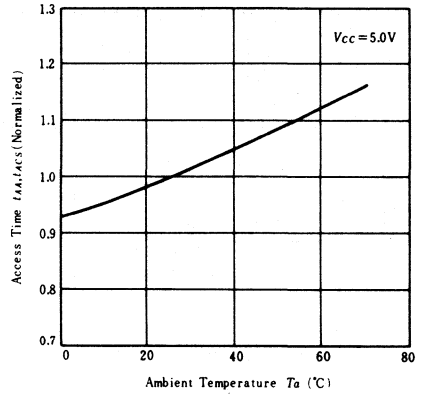

**ACCESS TIME
vs. LOAD CAPACITANCE**

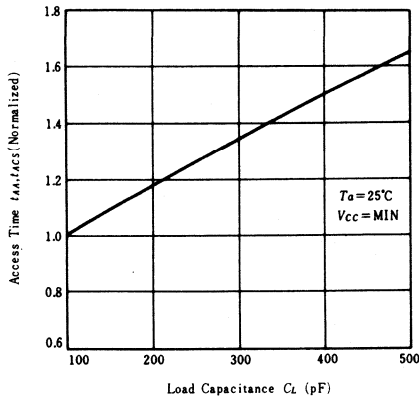

**SUPPLY CURRENT
vs. FREQUENCY**

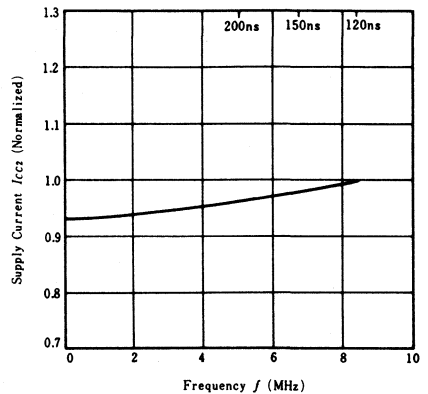

**LOW INPUT VOLTAGE
vs. SUPPLY VOLTAGE**

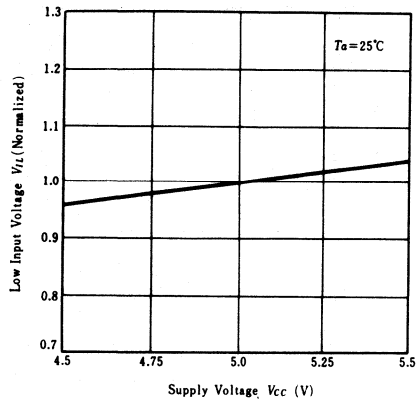

**HIGH INPUT VOLTAGE
vs. SUPPLY VOLTAGE**

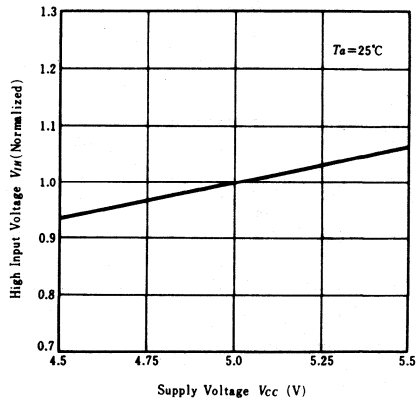

**OUTPUT CURRENT
vs. OUTPUT VOLTAGE**

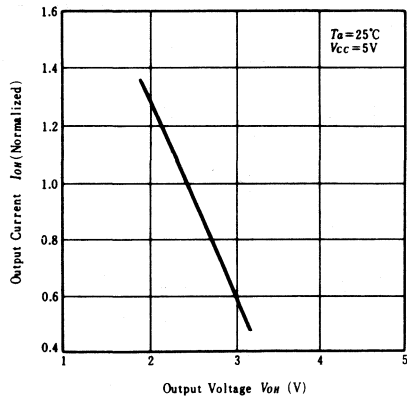

**OUTPUT CURRENT
vs. OUTPUT VOLTAGE**

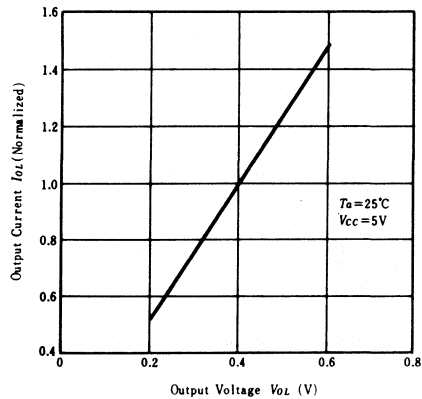

HM6116I-2, HM6116I-3, HM6116I-4

— Wide Operating Temperature Range —

2048-word × 8-bit High Speed Static CMOS RAM

■ FEATURES

- Wide Operating Temperature Range $-40\sim+85^{\circ}\text{C}$
- Single 5V Supply and High Density 24 Pin Package
- High speed: Fast Access Time 120ns/150ns/200ns (max.)
- Low Power Standby and Standby: 100 μW (typ.)
- Low Power Operation Operation: 180mW (typ.)
- Completely Static RAM: No clock or Timing Strobe Required
- Directly TTL Compatible: All Input and Output
- Pin Out Compatible with Standard 16K EPROM/MASK ROM
- Equal Access and Cycle Time

■ FUNCTIONAL BLOCK DIAGRAM

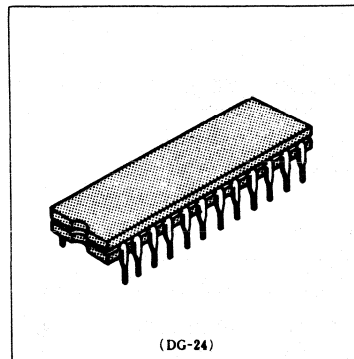
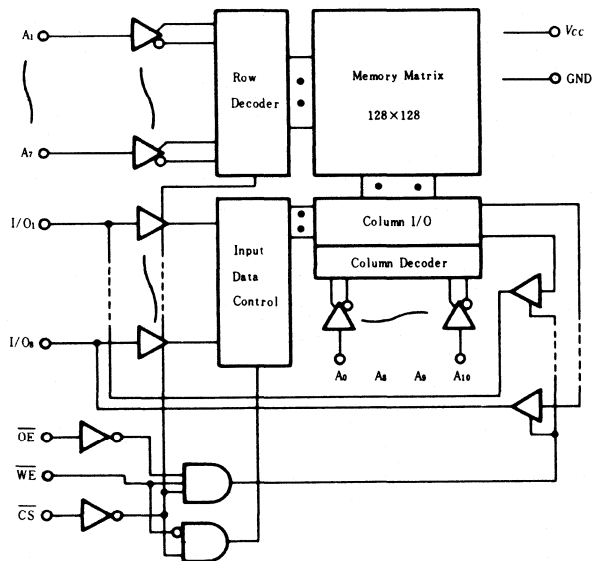

■ PIN ARRANGEMENT

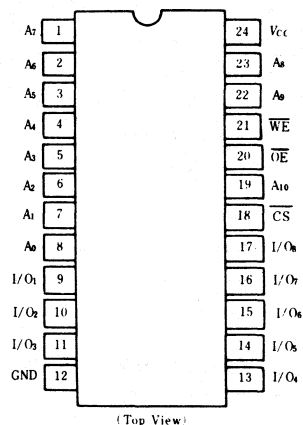

■ ABSOLUTE MAXIMUM RATINGS

Item	Symbol	Rating	Unit
Voltage on Any Pin Relative to GND	V_T	-0.5^* to $+7.0$	V
Operating Temperature	T_{opr}	-40 to $+85$	$^{\circ}\text{C}$
Storage Temperature	T_{stg}	-65 to $+150$	$^{\circ}\text{C}$
Power Dissipation	P_T	1.0	W

* Pulse Width 50ns : -1.5V

■ TRUTH TABLE

\overline{CS}	\overline{OE}	\overline{WE}	Mode	V_{CC} Current	I/O Pin	Ref. Cycle
H	×	×	Not Selected	I_{SB}, I_{SB1}	High Z	
L	L	H	Read	I_{CC}	Dout	Read Cycle (1)~(3)
L	H	L	Write	I_{CC}	Din	Write Cycle (1)
L	L	L	Write	I_{CC}	Din	Write Cycle (2)

■ RECOMMENDED DC OPERATING CONDITIONS ($T_a = -40$ to $+85^\circ\text{C}$)

Item	Symbol	min	typ	max	Unit
Supply Voltage	V_{CC}	4.5	5.0	5.5	V
	GND	0	0	0	V
Input Voltage	V_{IH}	2.2	3.5	6.0	V
	V_{IL}	-1.0*	—	0.8	V

* Pulse Width : 50ns, DC : V_{IL} min = -0.3V

■ DC AND OPERATING CHARACTERISTICS ($V_{CC} = 5V \pm 10\%$, GND = 0V, $T_a = -40$ to $+85^\circ\text{C}$)

Item	Symbol	Test Conditions	min	typ*	max	Unit
Input Leakage Current	$ I_{LI} $	$V_{CC} = 5.5V, V_{in} = \text{GND to } V_{CC}$	—	—	10	μA
Output Leakage Current	$ I_{LO} $	$\overline{CS} = V_{IH}$ or $\overline{OE} = V_{IH}, V_{iO} = \text{GND to } V_{CC}$	—	—	10	μA
Operating Power Supply Current	I_{CC}	$\overline{CS} = V_{IL}, I_{iO} = 0\text{mA}$	—	35	90	mA
	I_{CC1}^{**}	$V_{IH} = 3.5V, V_{IL} = 0.6V, I_{iO} = 0\text{mA}$	—	30	—	mA
Average Operating Current	I_{CC2}	Min. cycle, duty = 100%	—	35	90	mA
Standby Power Supply Current	I_{SB}	$\overline{CS} = V_{IH}$	—	4	20	mA
	I_{SB1}	$\overline{CS} \geq V_{CC} - 0.2V, V_{in} \geq V_{CC} - 0.2V$ or $V_{in} \leq 0.2V$	—	0.02	2	mA
Output Voltage	V_{OL}	$I_{OL} = 2.1\text{mA}$	—	—	0.4	V
	V_{OH}	$I_{OH} = -1.0\text{mA}$	2.4	—	—	V

* $V_{CC} = 5V, T_a = 25^\circ\text{C}$

** Reference Only

■ AC CHARACTERISTICS ($V_{CC} = 5V \pm 10\%$, $T_a = -40$ to $+85^\circ\text{C}$)

● AC TEST CONDITIONS

Input Pulse Levels: 0.8 to 2.4V

Input Rise and Fall Times: 10 ns

Input and Output Timing Reference Levels: 1.5V

Output Load: 1TTL Gate and $C_L = 100\text{pF}$ (including scope and jig)

● READ CYCLE

Item	Symbol	HM61161-2		HM61161-3		HM61161-4		Unit
		min	max	min	max	min	max	
Read Cycle Time	t_{RC}	120	—	150	—	200	—	ns
Address Access Time	t_{AA}	—	120	—	150	—	200	ns
Chip Select Access Time	t_{ACS}	—	120	—	150	—	200	ns
Chip Selection to Output in Low Z	t_{CLZ}	10	—	10	—	10	—	ns
Output Enable to Output Valid	t_{OE}	—	80	—	100	—	120	ns
Output Enable to Output in Low Z	t_{OLZ}	10	—	10	—	10	—	ns
Chip Deselection to Output in High Z	t_{CHZ}	0	40	0	50	0	60	ns
Chip Disable to Output in High Z	t_{OHZ}	0	40	0	50	0	60	ns
Output Hold from Address Change	t_{OH}	10	—	10	—	10	—	ns

● WRITE CYCLE

Item	Symbol	HM61161-2		HM61161-3		HM61161-4		Unit
		min	max	min	max	min	max	
Write Cycle Time	t_{WC}	120	—	150	—	200	—	ns
Chip Selection to End of Write	t_{CW}	70	—	90	—	120	—	ns
Address Valid to End of Write	t_{AW}	105	—	120	—	140	—	ns
Address Set Up Time	t_{AS}	20	—	20	—	20	—	ns
Write Pulse Width	t_{WP}	70	—	90	—	120	—	ns
Write Recovery Time	t_{WR}	5	—	10	—	10	—	ns
Output Disable to Output in High Z	t_{OHZ}	0	40	0	50	0	60	ns
Write to Output in High Z	t_{WHZ}	0	50	0	60	0	60	ns
Data to Write Time Overlap	t_{DW}	35	—	40	—	60	—	ns
Data Hold from Write Time	t_{DH}	5	—	10	—	10	—	ns
Output Active from End of Write	t_{OW}	5	—	10	—	10	—	ns

■ CAPACITANCE ($f=1\text{MHz}$, $T_a=25^\circ\text{C}$)

Item	Symbol	Test Conditions	typ	max	Unit
Input Capacitance	C_{in}	$V_{in}=0\text{V}$	3	5	pF
Input/Output Capacitance	$C_{I/O}$	$V_{I/O}=0\text{V}$	5	7	pF

Note) This parameter is sampled and not 100% tested.

■ TIMING WAVEFORM

● READ CYCLE (1) ⁽¹⁾ ⁽⁵⁾

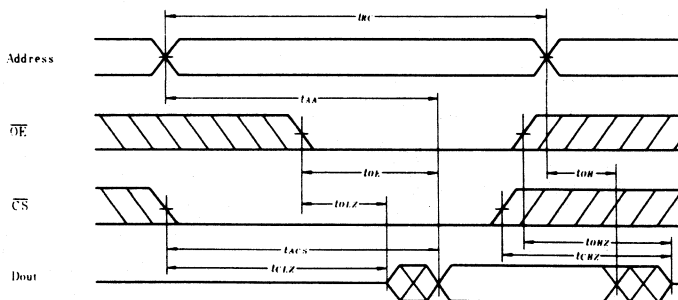

● READ CYCLE (2) ⁽¹⁾ ⁽²⁾ ⁽⁴⁾

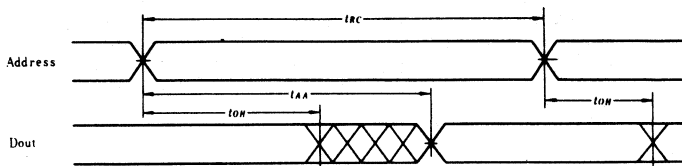

● READ CYCLE (3) ⁽¹⁾ ⁽³⁾ ⁽⁴⁾

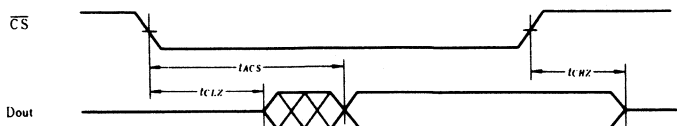

- NOTES:
- \overline{WE} is High for Read Cycle.
 - Device is continuously selected, $\overline{CS} = V_{LL}$.
 - Address Valid prior to or coincident with \overline{CS} transition Low.
 - $\overline{OE} = V_{LL}$.

WRITE CYCLE (1)

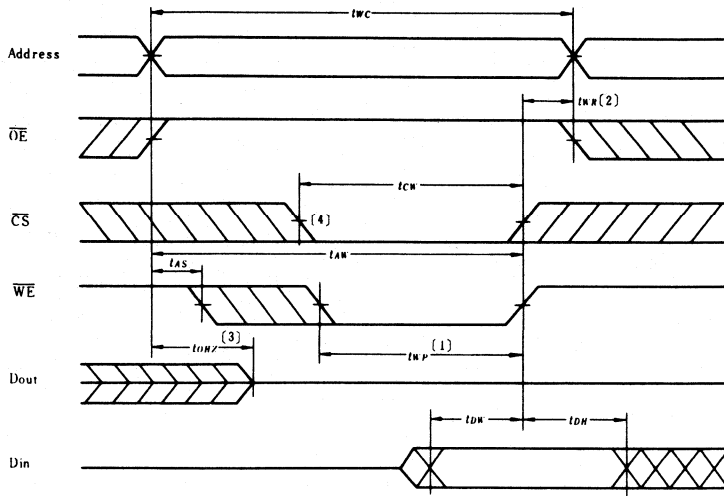

● WRITE CYCLE (2) ⁽⁵⁾

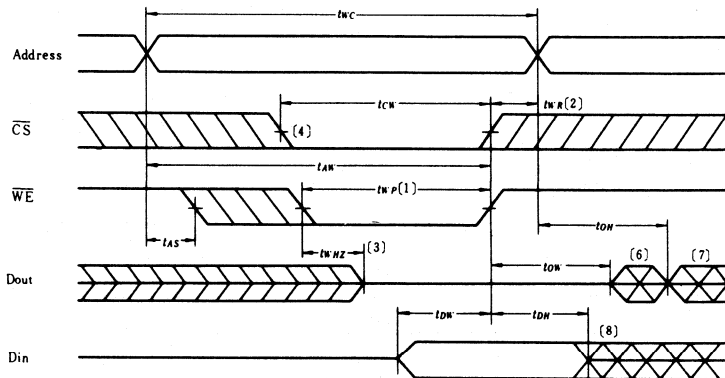

- NOTES:
1. A write occurs during the overlap (t_{WP}) of a low \overline{CS} and a low \overline{WE} .
 2. t_{WR} is measured from the earlier of \overline{CS} or \overline{WE} going high to the end of write cycle.
 3. During this period, I/O pins are in the output state so that the input signals of opposite phase to the outputs must not be applied.
 4. If the \overline{CS} low transition occurs simultaneously with the \overline{WE} low transitions or after the \overline{WE} transition, output remain in a high impedance state.
 5. \overline{OE} is continuously low. ($\overline{OE} = V_{IL}$)
 6. D_{out} is the same phase of write data of this write cycle.
 7. D_{out} is the read data of next address.
 8. If \overline{CS} is Low during this period, I/O pins are in the output state. Then the data input signals of opposite phase to the outputs must not be applied to them.

HM6116PI-2, HM6116PI-3, HM6116PI-4

— Wide Operating Temperature Range —

2048-word × 8-bit High Speed Static CMOS RAM

FEATURES

- Wide Operating Temperature Range $-40 \sim +85^{\circ}\text{C}$
- Single 5V Supply and High Density 24 Pin Package
- High speed: Fast Access Time 120ns/150ns/200ns (max.)
- Low Power Standby and Standby: 100 μW (typ.)
- Low Power Operation Operation: 180mW (typ.)
- Completely Static RAM: No clock or Timing Strobe Required
- Directly TTL Compatible: All Input and Output
- Pin Out Compatible with Standard 16K EPROM/MASK ROM
- Equal Access and Cycle Time

FUNCTIONAL BLOCK DIAGRAM

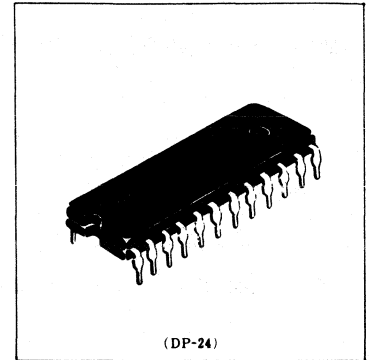
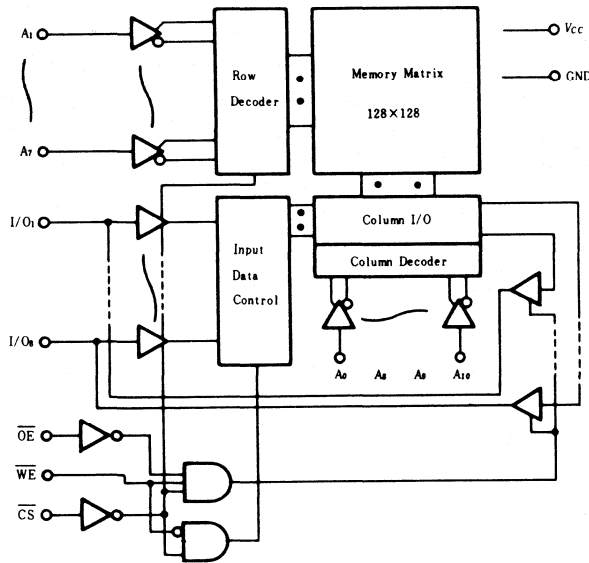

(DP-24)

PIN ARRANGEMENT

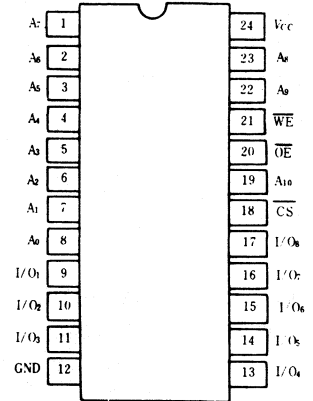

(Top View)

ABSOLUTE MAXIMUM RATINGS

Item	Symbol	Rating	Unit
Voltage on Any Pin Relative to GND	V_T	-0.5^* to $+7.0$	V
Operating Temperature	T_{opr}	-40 to $+85$	$^{\circ}\text{C}$
Storage Temperature	T_{sta}	-55 to $+125$	$^{\circ}\text{C}$
Power Dissipation	P_T	1.0	W

* Pulse Width 50ns : -1.5V

TRUTH TABLE

\overline{CS}	\overline{OE}	WE	Mode	V_{CC} Current	I/O Pin	Ref. Cycle
H	×	×	Not Selected	I_{SB}, I_{SB1}	High Z	
L	L	H	Read	I_{CC}	Dout	Read Cycle (1)~(3)
L	H	L	Write	I_{CC}	Din	Write Cycle (1)
L	L	L	Write	I_{CC}	Din	Write Cycle (2)

RECOMMENDED DC OPERATING CONDITIONS ($T_a = -40$ to $+85^\circ\text{C}$)

Item	Symbol	min	typ	max	Unit
Supply Voltage	V_{CC}	4.5	5.0	5.5	V
	GND	0	0	0	V
Input Voltage	V_{IH}	2.2	3.5	6.0	V
	V_{IL}	-1.0*	—	0.8	V

* Pulse Width : 50ns. DC : V_{IL} min = -0.3V

DC AND OPERATING CHARACTERISTICS ($V_{CC} = 5V \pm 10\%$, $GND = 0V$, $T_a = -40$ to $+85^\circ\text{C}$)

Item	Symbol	Test Conditions	min	typ*	max	Unit
Input Leakage Current	$ I_{LI} $	$V_{CC} = 5.5V$, $V_{in} = GND$ to V_{CC}	—	—	10	μA
Output Leakage Current	$ I_{LO} $	$\overline{CS} = V_{IH}$ or $\overline{OE} = V_{IH}$, $V_{i/o} = GND$ to V_{CC}	—	—	10	μA
Operating Power Supply Current	I_{CC}	$\overline{CS} = V_{IL}$, $I_{i/o} = 0\text{mA}$	—	35	90	mA
	I_{CC1}^{**}	$V_{IH} = 3.5V$, $V_{IL} = 0.6V$, $I_{i/o} = 0\text{mA}$	—	30	—	mA
Average Operating Current	I_{CC2}	Min. cycle, duty = 100%	—	35	90	mA
Standby Power Supply Current	I_{SB}	$\overline{CS} = V_{IH}$	—	4	20	mA
	I_{SB1}	$\overline{CS} \geq V_{CC} - 0.2V$, $V_{in} \geq V_{CC} - 0.2V$ or $V_{in} \leq 0.2V$	—	0.02	2	mA
Output Voltage	V_{OL}	$I_{OL} = 2.1\text{mA}$	—	—	0.4	V
	V_{OH}	$I_{OH} = -1.0\text{mA}$	2.4	—	—	V

* $V_{CC} = 5V$, $T_a = 25^\circ\text{C}$

** Reference Only

AC CHARACTERISTICS ($V_{CC} = 5V \pm 10\%$, $T_a = -40$ to $+85^\circ\text{C}$)

AC TEST CONDITIONS

Input Pulse Levels: 0.8 to 2.4V

Input Rise and Fall Times: 10 ns

Input and Output Timing Reference Levels: 1.5V

Output Load: 1TTL Gate and $C_L = 100\text{pF}$ (including scope and jig)

READ CYCLE

Item	Symbol	HM6116PI-2		HM6116PI-3		HM6116PI-4		Unit
		min	max	min	max	min	max	
Read Cycle Time	t_{RC}	120	—	150	—	200	—	ns
Address Access Time	t_{AA}	—	120	—	150	—	200	ns
Chip Select Access Time	t_{ACS}	—	120	—	150	—	200	ns
Chip Selection to Output in Low Z	t_{CLZ}	10	—	10	—	10	—	ns
Output Enable to Output Valid	t_{OE}	—	80	—	100	—	120	ns
Output Enable to Output in Low Z	t_{OLZ}	10	—	10	—	10	—	ns
Chip Deselection to Output in High Z	t_{CHZ}	0	40	0	50	0	60	ns
Chip Disable to Output in High Z	t_{OHZ}	0	40	0	50	0	60	ns
Output Hold from Address Change	t_{OH}	10	—	10	—	10	—	ns

● WRITE CYCLE

Item	Symbol	HM6116PI-2		HM6116PI-3		HM6116PI-4		Unit
		min	max	min	max	min	max	
Write Cycle Time	t_{wc}	120	—	150	—	200	—	ns
Chip Selection to End of Write	t_{cW}	70	—	90	—	120	—	ns
Address Valid to End of Write	t_{AW}	105	—	120	—	140	—	ns
Address Set Up Time	t_{AS}	20	—	20	—	20	—	ns
Write Pulse Width	t_{WP}	70	—	90	—	120	—	ns
Write Recovery Time	t_{WR}	5	—	10	—	10	—	ns
Output Disable to Output in High Z	t_{OHZ}	0	40	0	50	0	60	ns
Write to Output in High Z	t_{WHZ}	0	50	0	60	0	60	ns
Data to Write Time Overlap	t_{DW}	35	—	40	—	60	—	ns
Data Hold from Write Time	t_{DH}	5	—	10	—	10	—	ns
Output Active from End of Write	t_{OW}	5	—	10	—	10	—	ns

■ CAPACITANCE ($f=1\text{MHz}$, $T_a=25^\circ\text{C}$)

Item	Symbol	Test Conditions	typ	max	Unit
Input Capacitance	$C_{i\bullet}$	$V_{i\bullet}=0\text{V}$	3	5	pF
Input/Output Capacitance	C_{LO}	$V_{i\bullet}=0\text{V}$	5	7	pF

Note) This parameter is sampled and not 100% tested.

■ TIMING WAVEFORM

● READ CYCLE (1) ⁽¹⁾

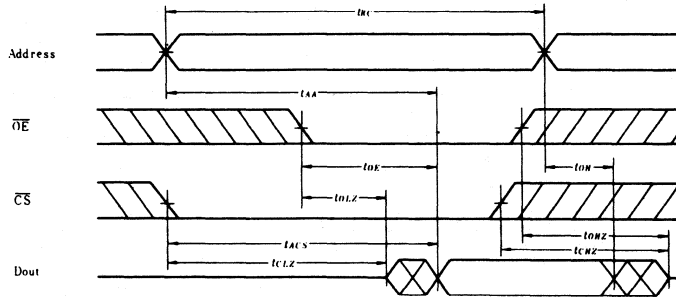

● READ CYCLE (2) ⁽¹⁾⁽²⁾⁽⁴⁾

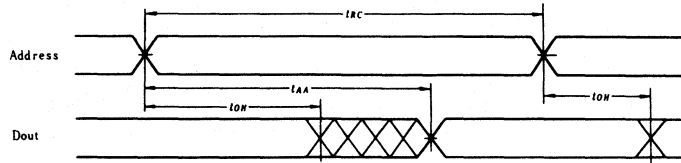

● READ CYCLE (3) ⁽¹⁾⁽³⁾⁽⁴⁾

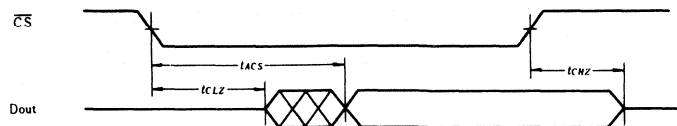

- NOTES:
1. \overline{WE} is High for Read Cycle.
 2. Device is continuously selected, $\overline{CS} = V_{IL}$.
 3. Address Valid prior to or coincident with \overline{CS} transition Low.
 4. $OE = V_{IL}$.

WRITE CYCLE (1)

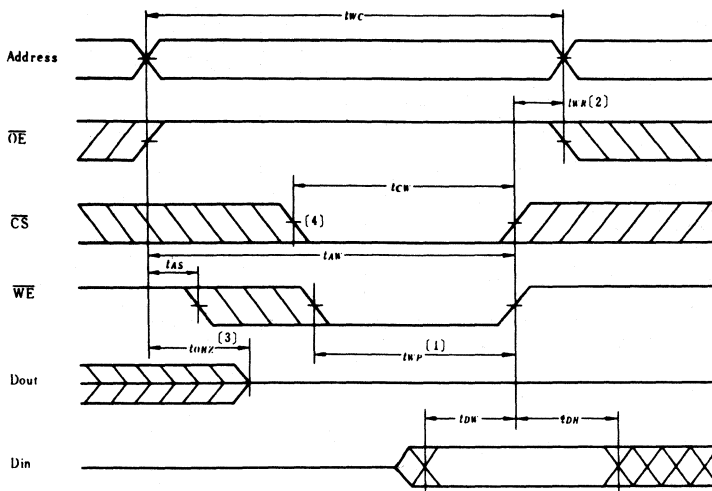

● WRITE CYCLE (2) (5)

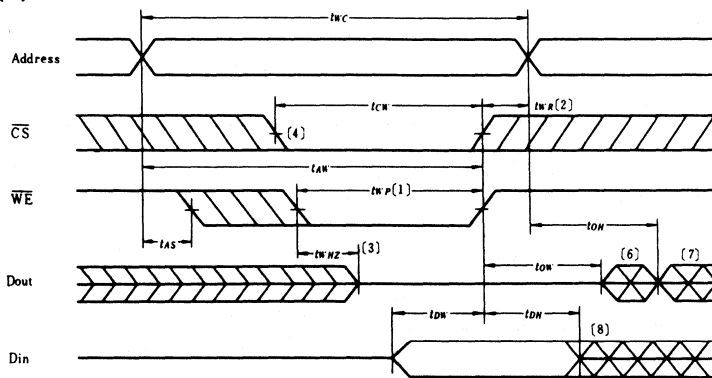

- NOTES:
1. A write occurs during the overlap (t_{WP}) of a low \overline{CS} and a low \overline{WE} .
 2. t_{WR} is measured from the earlier of \overline{CS} or \overline{WE} going high to the end of write cycle.
 3. During this period, I/O pins are in the output state so that the input signals of opposite phase to the outputs must not be applied.
 4. If the \overline{CS} low transition occurs simultaneously with the \overline{WE} low transitions or after the \overline{WE} transition, output remain in a high impedance state.
 5. \overline{OE} is continuously low. ($\overline{OE} = V_{IL}$)
 6. D_{out} is the same phase of write data of this write cycle.
 7. D_{out} is the read data of next address.
 8. If \overline{CS} is Low during this period, I/O pins are in the output state. Then the data input signals of opposite phase to the outputs must not be applied to them.

HM6116FP-2, HM6116FP-3, HM6116FP-4

2048-word × 8-bit High Speed Static CMOS RAM

FEATURES

- High Density Small-Sized Package
- Projection Area Reduced to One-Thirds of Conventional DIP
- Thickness Reduced to a Half of Conventional DIP
- Single 5V Supply
- High Speed: Fast Access Time 120ns/150ns/200ns (max.)
- Low Power Standby Standby: 100μW (typ.)
- Low Power Operation; Operation: 180mW (typ.)
- Completely Static RAM: No clock nor Timing Strobe Required
- Directly TTL Compatible: All Input and Output
- Equal Access and Cycle Time

FUNCTIONAL BLOCK DIAGRAM

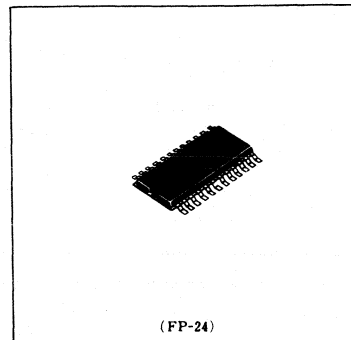
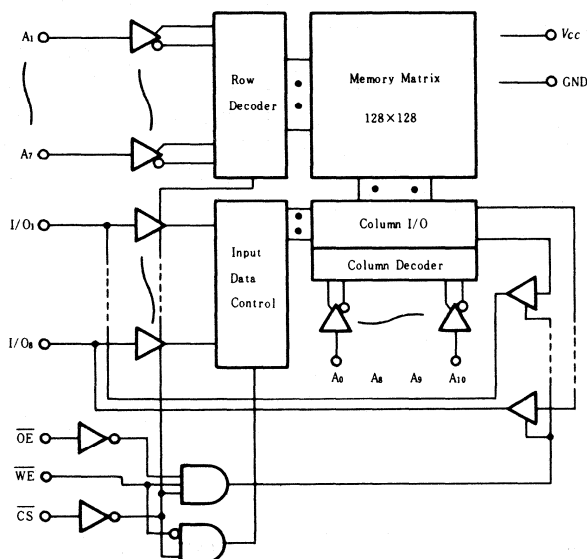

PIN ARRANGEMENT

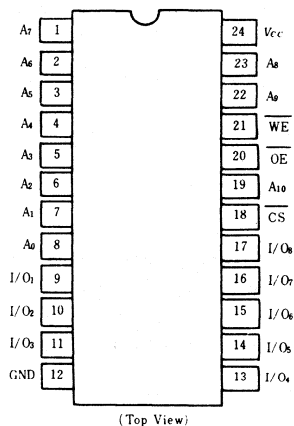

ABSOLUTE MAXIMUM RATINGS

Item	Symbol	Rating	Unit
Voltage on Any Pin Relative to GND	V_T	-0.5* to +7.0	V
Operating Temperature	T_{opr}	0 to +70	°C
Storage Temperature	T_{stg}	-55 to +125	°C
Temperature Under Bias	T_{bias}	-10 to +85	°C
Power Dissipation	P_T	1.0	W

* V_{TS} min = -1.5V (Pulse Width ≤ 50ns)

TRUTH TABLE

CS	OE	WE	Mode	V_{CC} Current	I/O Pin	Ref. Cycle
H	×	×	Not Selected	I_{SB}, I_{SB1}	High Z	
L	L	H	Read	I_{CC}	Dout	Read Cycle(1)~(3)
L	H	L	Write	I_{CC}	Din	Write Cycle(1)
L	L	L	Write	I_{CC}	Din	Write Cycle(2)

■ RECOMMENDED DC OPERATING CONDITIONS ($T_a=0$ to $+70^\circ\text{C}$)

Item	Symbol	min	typ	max	Unit
Supply Voltage	V_{CC}	4.5	5.0	5.5	V
	GND	0	0	0	V
Input Voltage	V_{IH}	2.2	3.5	6.0	V
	V_{IL}	-1.0*	—	0.8	V

* Pulse Width : 50ns, DC : V_{IL} min = -0.3V

■ DC AND OPERATING CHARACTERISTICS ($V_{CC}=5\text{V} \pm 10\%$, $GND=0\text{V}$, $T_a=0$ to $+70^\circ\text{C}$)

Item	Symbol	Test Conditions	HM6116FP-2			HM6116FP-3/-4			Unit
			min	typ*	max	min	typ*	max	
Input Leakage Current	$ I_{LI} $	$V_{CC}=5.5\text{V}$, $V_n=GND$ to V_{CC}	—	—	10	—	—	10	μA
Output Leakage Current	$ I_{LO} $	$\overline{CS}=V_{IH}$ or $\overline{OE}=V_{IH}$ $V_{IO}=GND$ to V_{CC}	—	—	10	—	—	10	μA
Operating Power Supply Current	I_{CC}	$\overline{CS}=V_{IL}$, $I_{LO}=0\text{mA}$	—	40	80	—	35	70	mA
	I_{CC1}^{**}	$V_{IH}=3.5\text{V}$, $V_{IL}=0.6\text{V}$, $I_{LO}=0\text{mA}$	—	35	—	—	30	—	mA
Average Operating Current	I_{CC2}	Min. cycle, duty=100%	—	40	80	—	35	70	mA
Standby Power Supply Current	I_{SB}	$\overline{CS}=V_{IH}$	—	5	15	—	5	15	mA
	I_{SB1}	$\overline{CS} \geq V_{CC}-0.2\text{V}$, $V_n \geq V_{CC}-0.2\text{V}$ or $V_n \leq 0.2\text{V}$	—	0.02	2	—	0.02	2	mA
Output Voltage	V_{OL}	$I_{OL}=4\text{mA}$	—	—	0.4	—	—	—	V
		$I_{OL}=2.1\text{mA}$	—	—	—	—	—	0.4	V
	V_{OH}	$I_{OH}=-1.0\text{mA}$	2.4	—	—	2.4	—	—	V

* $V_{CC}=5\text{V}$, $T_a=25^\circ\text{C}$

** Reference Only

■ AC CHARACTERISTICS ($V_{CC}=5\text{V} \pm 10\%$, $T_a=0$ to $+70^\circ\text{C}$)

● AC TEST CONDITIONS

Input Pulse Levels: 0.8 to 2.4V

Input Rise and Fall Times: 10 ns

Input and Output Timing Reference Levels: 1.5V

Output Load: 1TTL Gate and $C_L = 100\text{pF}$ (including scope and jig)

● READ CYCLE

Item	Symbol	HM6116FP-2		HM6116FP-3		HM6116FP-4		Unit
		min	max	min	max	min	max	
Read Cycle Time	t_{RC}	120	—	150	—	200	—	ns
Address Access Time	t_{AA}	—	120	—	150	—	200	ns
Chip Select Access Time	t_{ACS}	—	120	—	150	—	200	ns
Chip Selection to Output in Low Z	t_{CLZ}	10	—	15	—	15	—	ns
Output Enable to Output Valid	t_{OE}	—	80	—	100	—	120	ns
Output Enable to Output in Low Z	t_{OLZ}	10	—	15	—	15	—	ns
Chip Deselection to Output in High Z	t_{CHZ}	0	40	0	50	0	60	ns
Chip Disable to Output in High Z	t_{OHZ}	0	40	0	50	0	60	ns
Output Hold from Address Change	t_{OH}	10	—	15	—	15	—	ns

● WRITE CYCLE

Item	Symbol	HM6116FP-2		HM6116FP-3		HM6116FP-4		Unit
		min	max	min	max	min	max	
Write Cycle Time	t_{WC}	120	—	150	—	200	—	ns
Chip Selection to End of Write	t_{CW}	70	—	90	—	120	—	ns
Address Valid to End of Write	t_{AW}	105	—	120	—	140	—	ns
Address Set Up Time	t_{AS}	20	—	20	—	20	—	ns
Write Pulse Width	t_{WP}	70	—	90	—	120	—	ns
Write Recovery Time	t_{WR}	5	—	10	—	10	—	ns
Output Disable to Output in High Z	t_{ONZ}	0	40	0	50	0	60	ns
Write to Output in High Z	t_{WHz}	0	50	0	60	0	60	ns
Data to Write Time Overlap	t_{DW}	35	—	40	—	60	—	ns
Data Hold from Write Time	t_{DH}	5	—	10	—	10	—	ns
Output Active from End of Write	t_{OW}	5	—	10	—	10	—	ns

■ CAPACITANCE ($f=1\text{MHz}$, $T_a=25^\circ\text{C}$)

Item	Symbol	Test Conditions	typ	max	Unit
Input Capacitance	C_{in}	$V_{in}=0\text{V}$	3	5	pF
Input/Output Capacitance	$C_{I/O}$	$V_{I/O}=0\text{V}$	5	7	pF

Note) This parameter is sampled and not 100% tested.

■ TIMING WAVEFORM

● READ CYCLE (1) ⁽¹⁾

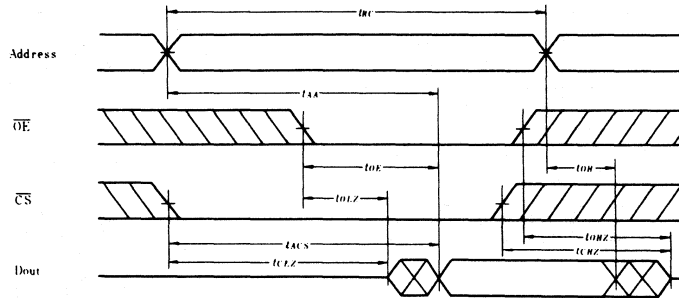

● READ CYCLE (2) ⁽¹⁾⁽²⁾⁽⁴⁾

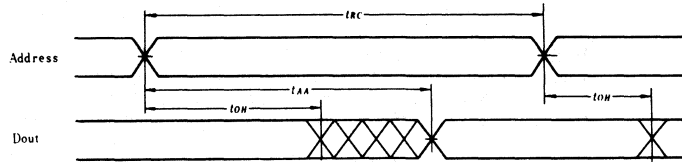

● READ CYCLE (3) ⁽¹⁾⁽³⁾⁽⁴⁾

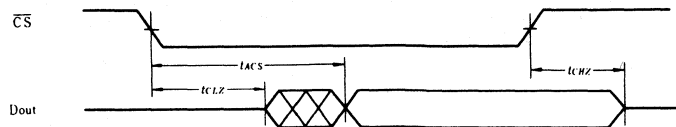

- NOTES: 1. WE is High for Read Cycle.
 2. Device is continuously selected, $\overline{CS} = V_{IL}$.
 3. Address Valid prior to or coincident with \overline{CS} transition Low.
 4. $\overline{OE} = V_{IL}$.

■ TIMING WAVEFORM

● WRITE CYCLE (1) ⁽¹⁾

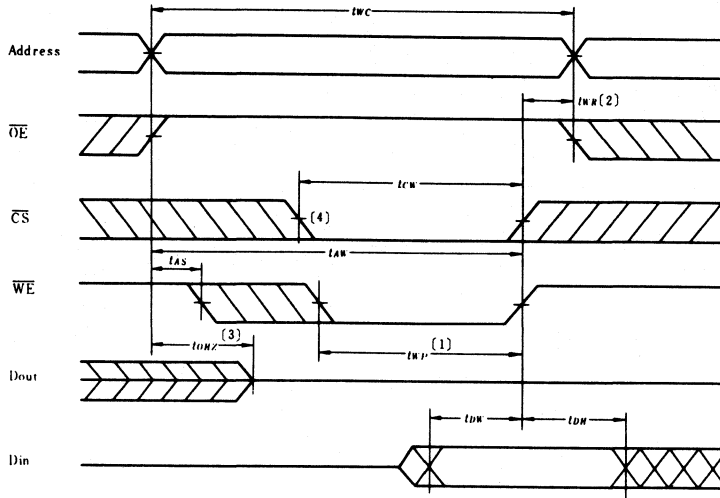

● WRITE CYCLE (2) ⁽⁵⁾

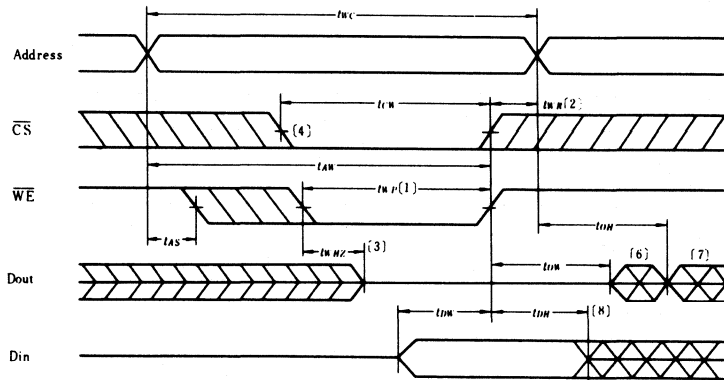

- NOTES:
1. A write occurs during the overlap (t_{WP}) of a low \overline{CS} and a low \overline{WE} .
 2. t_{WR} is measured from the earlier of \overline{CS} or \overline{WE} going high to the end of write cycle.
 3. During this period, I/O pins are in the output state so that the input signals of opposite phase to the outputs must not be applied.
 4. If the \overline{CS} low transition occurs simultaneously with the \overline{WE} low transitions or after the \overline{WE} transition, output remain in a high impedance state.
 5. \overline{OE} is continuously low. ($\overline{OE} = V_{IL}$)
 6. D_{out} is the same phase of write data of this write cycle.
 7. D_{out} is the read data of next address.
 8. If \overline{CS} is Low during this period, I/O pins are in the output state. Then the data input signals of opposite phase to the outputs must not be applied to them.

SUPPLY CURRENT vs. SUPPLY VOLTAGE

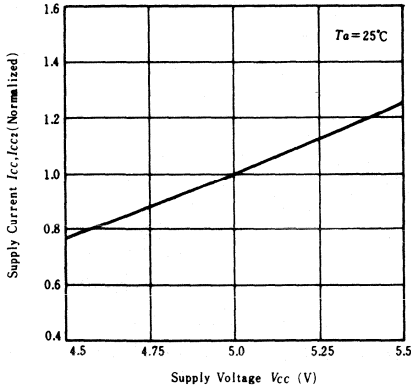

SUPPLY CURRENT vs. AMBIENT TEMPERATURE

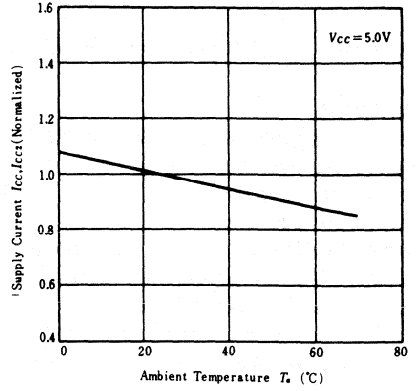

ACCESS TIME vs. SUPPLY VOLTAGE

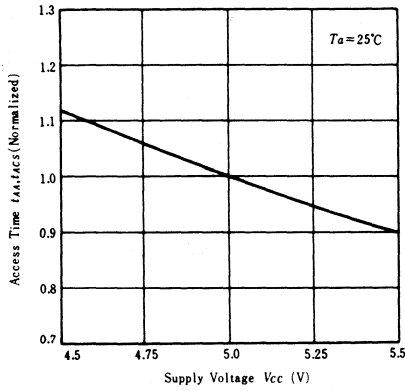

ACCESS TIME vs. AMBIENT TEMPERATURE

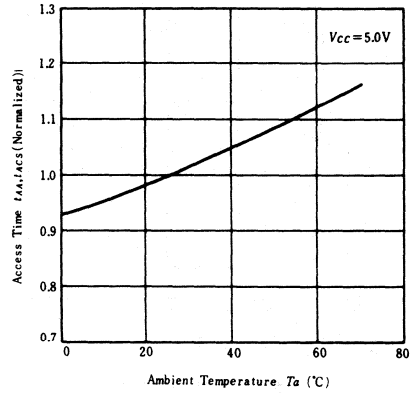

ACCESS TIME vs. LOAD CAPACITANCE

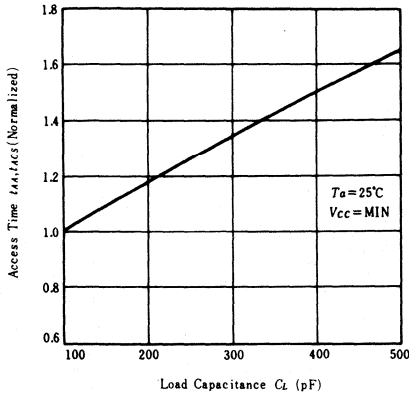

SUPPLY CURRENT vs. FREQUENCY

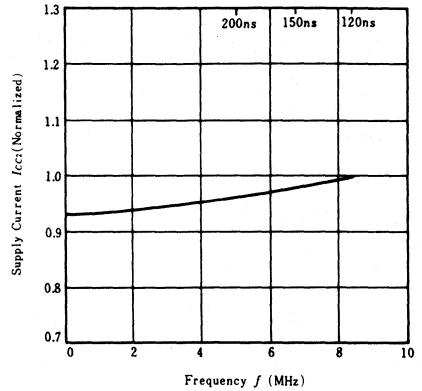

HM6116CG-2, HM6116CG-3, HM6116CG-4

2048-word × 8-bit High Speed Static CMOS RAM

FEATURES

- Single 5V Supply and High Density 32 pin-Leadless-Chip Carrier
- High speed: Fast Access Time 120ns/150ns/200ns (max.)
- Low Power Standby and Standby: 100μW (typ.)
- Low Power Operation Operation: 180mW (typ.)
- Completely Static RAM: No Clock or Timing Strobe Required
- Directly TTL Compatible: All Input and Output
- Equal Access and Cycle Time

FUNCTIONAL BLOCK DIAGRAM

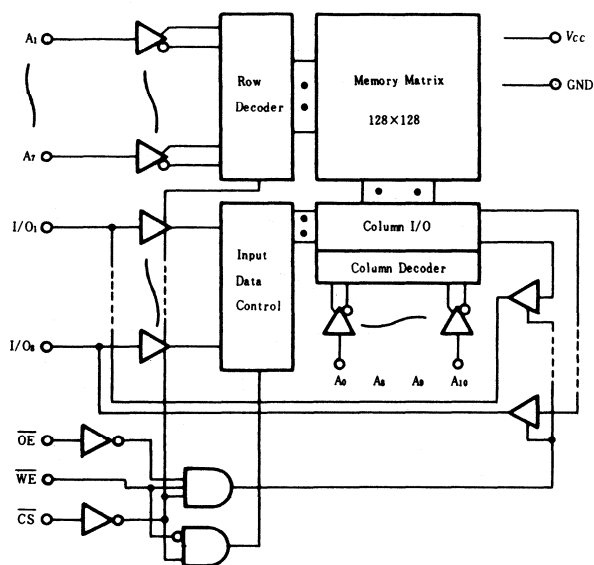

ABSOLUTE MAXIMUM RATINGS

Item	Symbol	Rating	Unit
Voltage on Any Pin Relative to GND	V_T	-0.5* to +7.0	V
Operating Temperature	T_{opr}	0 to +70	°C
Storage Temperature	T_{stg}	-65 to +150	°C
Power Dissipation	P_T	1.0	W

* Pulse Width 50ns : -1.5V

TRUTH TABLE

\overline{CS}	\overline{OE}	\overline{WE}	Mode	V_{CC} Current	I/O Pin	Ref. Cycle
H	×	×	Not Selected	I_{SB}, I_{SB1}	High Z	
L	L	H	Read	I_{CC}	Dout	Read Cycle (1)~(3)
L	H	L	Write	I_{CC}	Din	Write Cycle (1)
L	L	L	Write	I_{CC}	Din	Write Cycle (2)

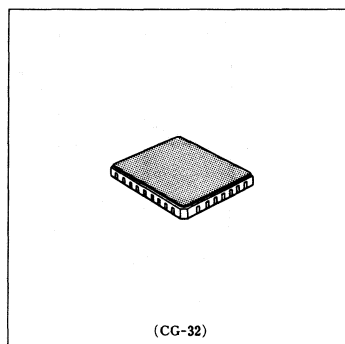

PIN ARRANGEMENT

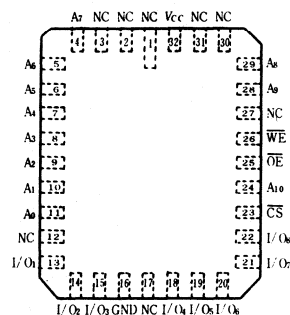

(Top View)

RECOMMENDED DC OPERATING CONDITIONS ($T_a=0$ to $+70^\circ\text{C}$)

Item	Symbol	min	typ	max	Unit
Supply Voltage	V_{CC}	4.5	5.0	5.5	V
	GND	0	0	0	V
Input Voltage	V_{IH}	2.2	3.5	6.0	V
	V_{IL}	-1.0*	—	0.8	V

* Pulse Width : 50ns, DC : V_{IL} min = -0.3V

DC AND OPERATING CHARACTERISTICS ($V_{CC}=5V \pm 10\%$, $GND=0V$, $T_a=0$ to $+70^\circ\text{C}$)

Item	Symbol	Test Conditions	HM6116CG-2			HM6116CG-3/-4			Unit
			min	typ*	max	min	typ*	max	
Input Leakage Current	$ I_{LI} $	$V_{CC}=5.5V$, $V_{in}=GND$ to V_{CC}	—	—	10	—	—	10	μA
Output Leakage Current	$ I_{LO} $	$\overline{CS}=V_{IH}$ or $\overline{OE}=V_{IH}$, $V_{i,o}=GND$ to V_{CC}	—	—	10	—	—	10	μA
Operating Power Supply Current	I_{CC}	$\overline{CS}=V_{IL}$, $I_{i,o}=0\text{mA}$	—	40	80	—	35	70	mA
	I_{CC1}^{**}	$V_{IH}=3.5V$, $V_{IL}=0.6V$, $I_{i,o}=0\text{mA}$	—	35	—	—	30	—	mA
Average Operating Current	I_{CC2}	Min. cycle, duty=100%	—	40	80	—	35	70	mA
Standby Power Supply Current	I_{SB}	$\overline{CS}=V_{IH}$	—	5	15	—	5	15	mA
	I_{SB1}	$\overline{CS} \geq V_{CC}-0.2V$, $V_{in} \geq V_{CC}-0.2V$ or $V_{in} \leq 0.2V$	—	0.02	2	—	0.02	2	mA
Output Voltage	V_{OL}	$I_{OL}=4\text{mA}$	—	—	0.4	—	—	—	V
		$I_{OL}=2.1\text{mA}$	—	—	—	—	—	0.4	V
	V_{OH}	$I_{OH}=-1.0\text{mA}$	2.4	—	—	2.4	—	—	V

* $V_{CC}=5V$, $T_a=25^\circ\text{C}$

** Reference Only

AC CHARACTERISTICS ($V_{CC}=5V \pm 10\%$, $T_a=0$ to $+70^\circ\text{C}$)

AC TEST CONDITIONS

Input Pulse Levels: 0.8 to 2.4V

Input Rise and Fall Times: 10 ns

Input and Output Timing Reference Levels: 1.5V

Output Load: 1TTL Gate and $C_L = 100\text{pF}$ (including scope and jig)

READ CYCLE

Item	Symbol	HM6116CG-2		HM6116CG-3		HM6116CG-4		Unit
		min	max	min	max	min	max	
Read Cycle Time	t_{RC}	120	—	150	—	200	—	ns
Address Access Time	t_{AA}	—	120	—	150	—	200	ns
Chip Select Access Time	t_{ACS}	—	120	—	150	—	200	ns
Chip Selection to Output in Low Z	t_{CLZ}	10	—	15	—	15	—	ns
Output Enable to Output Valid	t_{OE}	—	80	—	100	—	120	ns
Output Enable to Output in Low Z	t_{OLZ}	10	—	15	—	15	—	ns
Chip Deselection to Output in High Z	t_{CHZ}	0	40	0	50	0	60	ns
Chip Disable to Output in High Z	t_{OHZ}	0	40	0	50	0	60	ns
Output Hold from Address Change	t_{OH}	10	—	15	—	15	—	ns

● WRITE CYCLE

Item	Symbol	HM6116CG-2		HM6116CG-3		HM6116CG-4		Unit
		min	max	min	max	min	max	
Write Cycle Time	t_{WC}	120	—	150	—	200	—	ns
Chip Selection to End of Write	t_{CW}	70	—	90	—	120	—	ns
Address Valid to End of Write	t_{AW}	105	—	120	—	140	—	ns
Address Set Up Time	t_{AS}	20	—	20	—	20	—	ns
Write Pulse Width	t_{WP}	70	—	90	—	120	—	ns
Write Recovery Time	t_{WR}	5	—	10	—	10	—	ns
Output Disable to Output in High Z	t_{OHZ}	0	40	0	50	0	60	ns
Write to Output in High Z	t_{WZH}	0	50	0	60	0	60	ns
Data to Write Time Overlap	t_{DW}	35	—	40	—	60	—	ns
Data Hold from Write Time	t_{DH}	5	—	10	—	10	—	ns
Output Active from End of Write	t_{OW}	5	—	10	—	10	—	ns

■ CAPACITANCE ($f=1\text{MHz}$, $T_a=25^\circ\text{C}$)

Item	Symbol	Test Conditions	typ	max	Unit
Input Capacitance	C_{in}	$V_{in}=0\text{V}$	3	5	pF
Input/Output Capacitance	$C_{I/O}$	$V_{I/O}=0\text{V}$	5	7	pF

Note) This parameter is sampled and not 100% tested.

■ TIMING WAVEFORM

● READ CYCLE (1) ⁽¹⁾

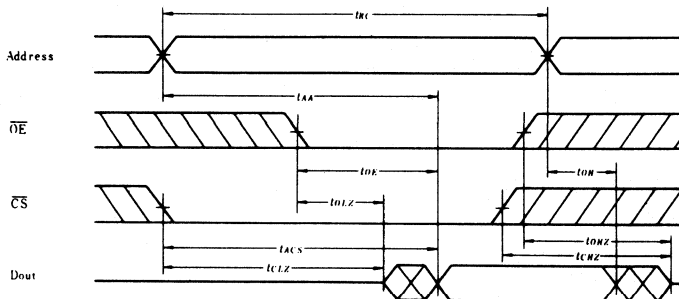

● READ CYCLE (2) ⁽¹⁾⁽²⁾⁽⁴⁾

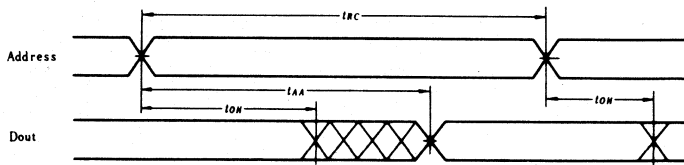

● READ CYCLE (3) ⁽¹⁾⁽³⁾⁽⁴⁾

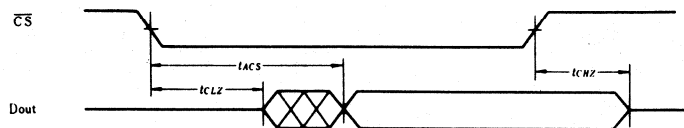

- NOTES: 1. WE is High for Read Cycle.
 2. Device is continuously selected, $\overline{CS} = V_{IL}$.
 3. Address Valid prior to or coincident with \overline{CS} transition Low.
 4. $\overline{OE} = V_{IL}$.

WRITE CYCLE (1) ⁽¹⁾

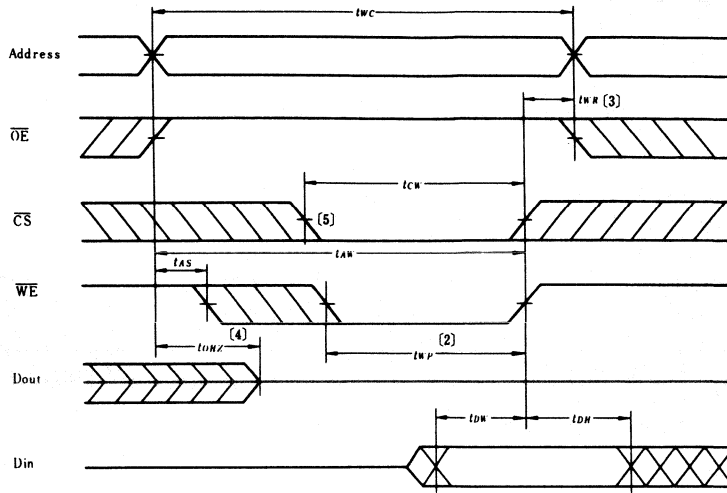

● WRITE CYCLE (2) ⁽⁵⁾

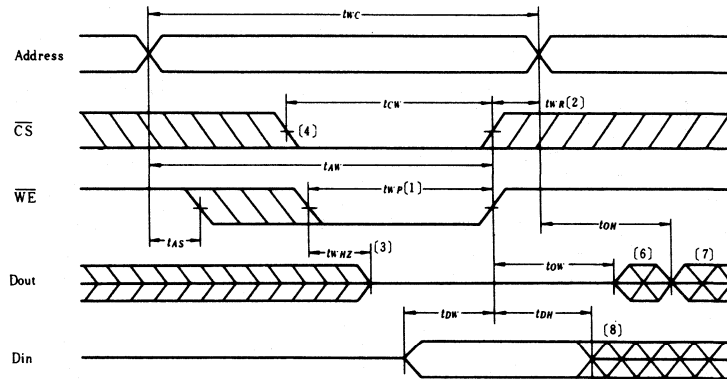

- NOTES:
1. A write occurs during the overlap (t_{WP}) of a low \overline{CS} and a low \overline{WE} .
 2. t_{WR} is measured from the earlier of \overline{CS} or \overline{WE} going high to the end of write cycle.
 3. During this period, I/O pins are in the output state so that the input signals of opposite phase to the outputs must not be applied.
 4. If the \overline{CS} low transition occurs simultaneously with the \overline{WE} low transitions or after the \overline{WE} transition, output remain in a high impedance state.
 5. \overline{OE} is continuously low. ($\overline{OE} = V_{IL}$)
 6. D_{out} is the same phase of write data of this write cycle.
 7. D_{out} is the read data of next address.
 8. If \overline{CS} is Low during this period, I/O pins are in the output state. Then the data input signals of opposite phase to the outputs must not be applied to them.

HM6116L-2, HM6116L-3, HM6116L-4

2048-word × 8-bit High Speed Static CMOS RAM

FEATURES

- Single 5V Supply and High Density 24 Pin Package
- High Speed: Fast Access Time 120ns/150ns/200ns (max.)
Low Power Standby and Standby: 20μW (typ.)
- Low Power Operation; Operation: 160mW (typ.)
- Completely Static RAM: No clock nor Timing Strobe Required
- Directly TTL Compatible: All Input and Output
- Pin Out Compatible with Standard 16K EPROM/MASK ROM
- Equal Access and Cycle Time
- Capability of Battery Back up Operation

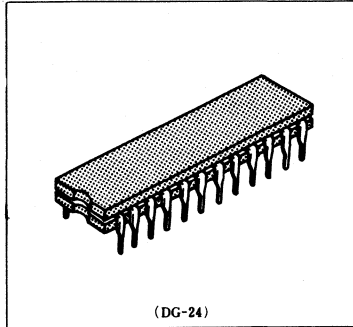

FUNCTIONAL BLOCK DIAGRAM

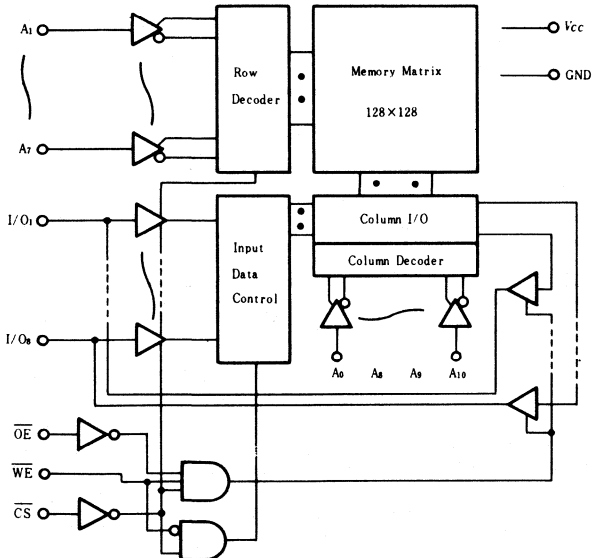

PIN ARRANGEMENT

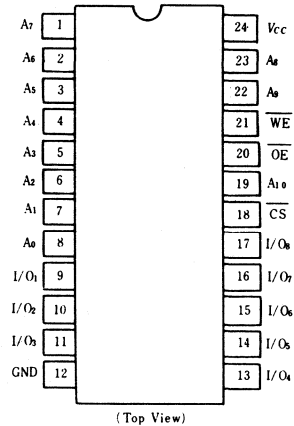

ABSOLUTE MAXIMUM RATINGS

Item	Symbol	Rating	Unit
Voltage on Any Pin Relative to GND	V_T	-0.5* to +7.0	V
Operating Temperature	T_{op}	0 to +70	°C
Storage Temperature	T_{stg}	-65 to +150	°C
Temperature Under Bias	T_{bias}	-10 to +85	°C
Power Dissipation	P_T	1.0	W

* Pulse Width 50ns : -1.5V

TRUTH TABLE

CS	OE	WE	Mode	V_{cc} Current	I/O Pin	Ref. Cycle
H	×	×	Not Selected	I_{SB}, I_{SB1}	High Z	
L	L	H	Read	I_{cc}	Dout	Read Cycle (1)~(3)
L	H	L	Write	I_{cc}	Din	Write Cycle (1)
L	L	L	Write	I_{cc}	Din	Write Cycle (2)

RECOMMENDED DC OPERATING CONDITIONS ($T_a=0$ to $+70^\circ\text{C}$)

Item	Symbol	min	typ	max	Unit
Supply Voltage	V_{CC}	4.5	5.0	5.5	V
	GND	0	0	0	V
Input Voltage	V_{IH}	2.2	3.5	6.0	V
	V_{IL}	-1.0*	—	0.8	V

* Pulse Width: 50ns, DC: V_{IL} min = -0.3V

DC AND OPERATING CHARACTERISTICS ($V_{CC}=5\text{V} \pm 10\%$, GND=0V, $T_a=0$ to $+70^\circ\text{C}$)

Item	Symbol	Test Conditions	HM6116L/P-2			HM6116L/P-3/-4			Unit
			min	typ*	max	min	typ*	max	
Input Leakage Current	$ I_{LI} $	$V_{CC}=5.5\text{V}$, $V_{in}=\text{GND to } V_{CC}$	—	—	2	—	—	2	μA
Output Leakage Current	$ I_{LO} $	$\overline{\text{CS}}=V_{IH}$ or $\overline{\text{OE}}=V_{IH}$, $V_{I/O}=\text{GND to } V_{CC}$	—	—	2	—	—	2	μA
Operating Power Supply Current	I_{CC}	$\overline{\text{CS}}=V_{IL}$, $I_{I/O}=0\text{mA}$	—	35	70	—	30	60	mA
	I_{CC1}^{**}	$V_{IH}=3.5\text{V}$, $V_{IL}=0.6\text{V}$, $I_{I/O}=0\text{mA}$	—	30	—	—	25	—	mA
Average Operating Current	I_{CC2}	min. cycle, duty = 100%	—	35	70	—	30	60	mA
Standby Power Supply Current	I_{SB}	$\overline{\text{CS}}=V_{IH}$	—	4	12	—	4	12	mA
	I_{SB1}	$\overline{\text{CS}} \geq V_{CC} - 0.2\text{V}$, $V_{in} \geq V_{CC} - 0.2\text{V}$ or $V_{in} \leq 0.2\text{V}$	—	4	100	—	4	100	μA
Output Voltage	V_{OL}	$I_{OL}=4\text{mA}$	—	—	0.4	—	—	—	V
		$I_{OL}=2.1\text{mA}$	—	—	—	—	—	0.4	
	V_{OH}	$I_{OH}=-1.0\text{mA}$	2.4	—	—	2.4	—	—	V

* : $V_{CC}=5\text{V}$, $T_a=25^\circ\text{C}$

** : Reference Only

AC CHARACTERISTICS ($V_{CC}=5\text{V} \pm 10\%$, $T_a=0$ to $+70^\circ\text{C}$)

AC TEST CONDITIONS

Input Pulse Levels: 0.8 to 2.4V

Input Rise and Fall Times: 10 ns

Input and Output Timing Reference Levels: 1.5V

Output Load: 1TTL Gate and $C_L = 100\text{pF}$ (including scope and jig)

READ CYCLE

Item	Symbol	HM6116L-2		HM6116L-3		HM6116L-4		Unit
		min	max	min	max	min	max	
Read Cycle Time	t_{RC}	120	—	150	—	200	—	ns
Address Access Time	t_{AA}	—	120	—	150	—	200	ns
Chip Select Access Time	t_{ACS}	—	120	—	150	—	200	ns
Chip Selection to Output in Low Z	t_{CLZ}	10	—	15	—	15	—	ns
Output Enable to Output Valid	t_{OE}	—	80	—	100	—	120	ns
Output Enable to Output in Low Z	t_{OLZ}	10	—	15	—	15	—	ns
Chip deselection to Output in High Z	t_{CHZ}	0	40	0	50	0	60	ns
Chip Disable to Output in High Z	t_{OHZ}	0	40	0	50	0	60	ns
Output Hold from Address Change	t_{OH}	10	—	15	—	15	—	ns

● WRITE CYCLE

Item	Symbol	HM6116L-2		HM6116L-3		HM6116L-4		Unit
		min	max	min	max	min	max	
Write Cycle Time	t_{WC}	120	—	150	—	200	—	ns
Chip Selection to End of Write	t_{CW}	70	—	90	—	120	—	ns
Address Valid to End of Write	t_{AW}	105	—	120	—	140	—	ns
Address Set Up Time	t_{AS}	20	—	20	—	20	—	ns
Write Pulse Width	t_{WP}	70	—	90	—	120	—	ns
Write Recovery Time	t_{WR}	5	—	10	—	10	—	ns
Output Disable to Output in High Z	t_{OHZ}	0	40	0	50	0	60	ns
Write to Output in High Z	t_{WHZ}	0	50	0	60	0	60	ns
Data to Write Time Overlap	t_{DW}	35	—	40	—	60	—	ns
Data Hold from Write Time	t_{DH}	5	—	10	—	10	—	ns
Output Active from End of Write	t_{OW}	5	—	10	—	10	—	ns

■ CAPACITANCE ($f=1\text{MHz}$, $T_a=25^\circ\text{C}$)

Item	Symbol	Test Conditions	typ	max	Unit
Input Capacitance	C_{in}	$V_{in}=0\text{V}$	3	5	pF
Input/Output Capacitance	$C_{I/O}$	$V_{I/O}=0\text{V}$	5	7	pF

Note) This parameter is sampled and not 100% tested.

■ TIMING WAVEFORM

● Read Cycle (1) ⁽¹⁾

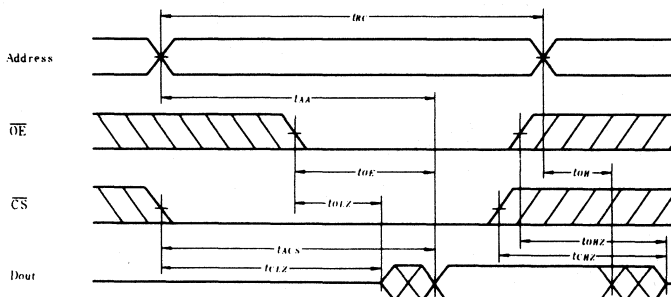

● Read Cycle (2) ^{(1), (2), (4)}

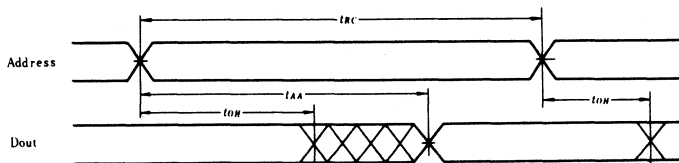

● Read Cycle (3) ^{(1), (3), (4)}

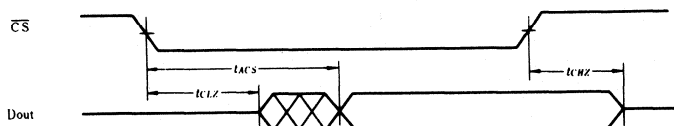

- NOTES: 1. \overline{WE} is High for Read Cycle.
 2. Device is continuously selected, $\overline{CS} = V_{IL}$.
 3. Address Valid prior to or coincident with \overline{CS} transition Low.
 4. $\overline{OE} = V_{IL}$.

● Write Cycle (1)

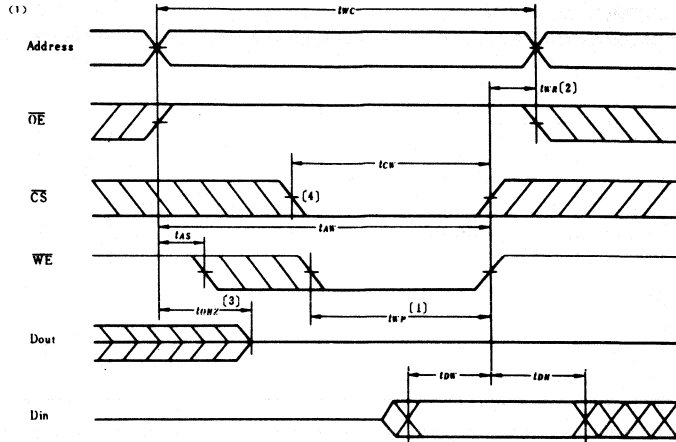

● Write Cycle (2)

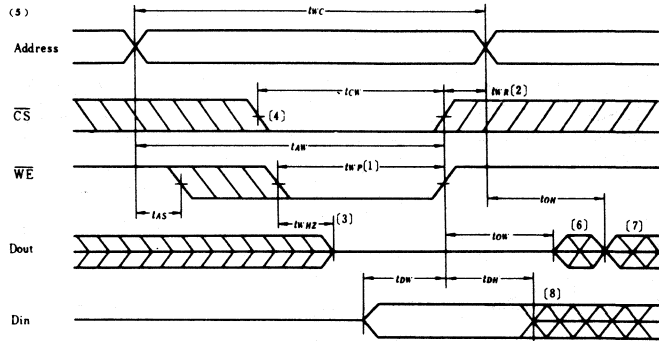

- NOTES: 1. A write occurs during the overlap (t_{WP}) of a low \overline{CS} and a low \overline{WE} .
 2. t_{WR} is measured from the earlier of \overline{CS} or \overline{WE} going high to the end of write cycle.
 3. During this period, I/O pins are in the output state so that the input signals of opposite phase to the outputs must not be applied.
 4. If the \overline{CS} low transition occurs simultaneously with the \overline{WE} low transitions or after the \overline{WE}

- transition, output remain in a high impedance state.
 5. \overline{OE} is continuously low. ($\overline{OE} = V_{IL}$)
 6. D_{OUT} is the same phase of write data of this write cycle.
 7. D_{OUT} is the read data of next address.
 8. If \overline{CS} is Low during this period, I/O pins are in the output state. Then the data input signals of opposite phase to the outputs must not be applied to them.

■ LOW V_{CC} DATA RETENTION CHARACTERISTICS ($T_a = 0$ to $+70^\circ\text{C}$)

Item	Symbol	Test Conditions	min	typ	max	Unit
V_{CC} for Data Retention	V_{DR}	$\overline{CS} \geq V_{CC} - 0.2V, V_{iA} \geq V_{CC} - 0.2V$ or $V_{iA} \leq 0.2V$	2.0	—	—	V
Data Retention Current	I_{CCDR}^{**}	$V_{CC} = 3.0V, \overline{CS} \geq 2.8V, V_{iA} \geq 2.8V$ or $V_{iA} \leq 0.2V$	—	—	50	μA
Chip Deselect to Data Retention Time	t_{CDR}	See Retention Waveform	0	—	—	ns
Operation Recovery Time	t_R		t_{RC}^{**}	—	—	ns

* $V_{iL} = -0.3V$ min.
 ** t_{RC} - Read Cycle Time.

● Low V_{CC} Data Retention Waveform

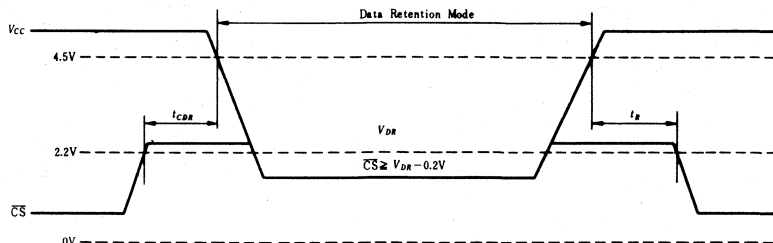

SUPPLY CURRENT vs. SUPPLY VOLTAGE

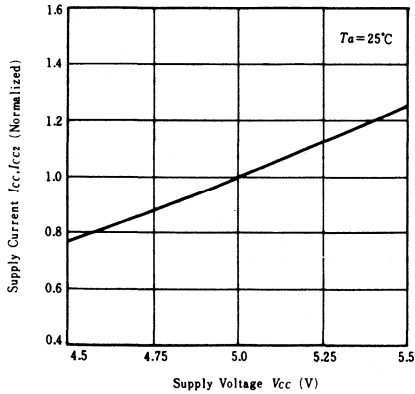

SUPPLY CURRENT vs. AMBIENT TEMPERATURE

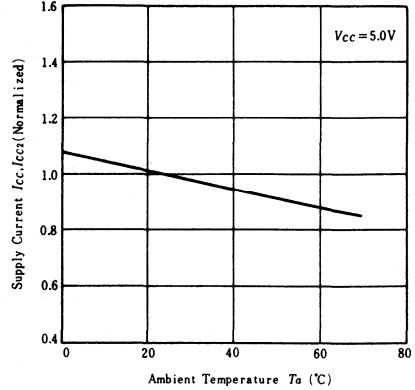

ACCESS TIME vs. SUPPLY VOLTAGE

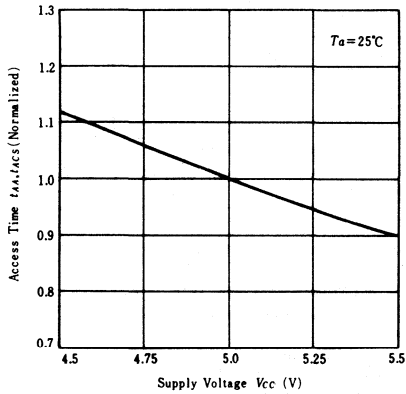

ACCESS TIME vs. AMBIENT TEMPERATURE

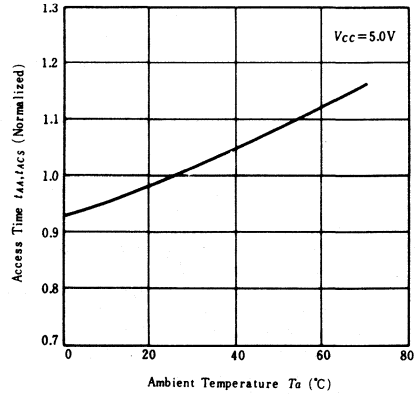

ACCESS TIME vs. LOAD CAPACITANCE

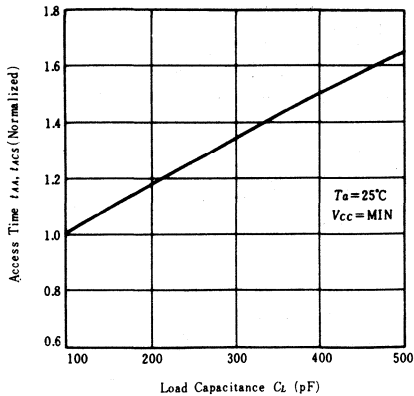

SUPPLY CURRENT vs. FREQUENCY

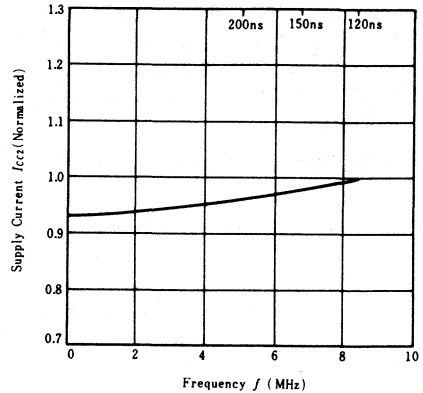

LOW INPUT VOLTAGE vs. SUPPLY VOLTAGE

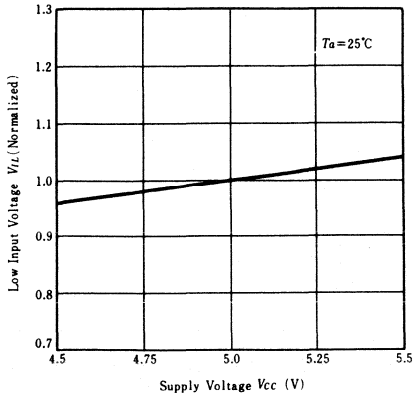

HIGH INPUT VOLTAGE vs. SUPPLY VOLTAGE

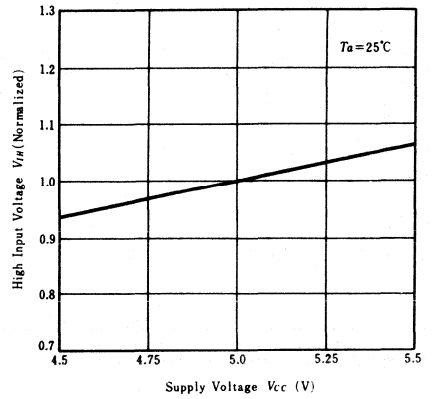

OUTPUT CURRENT vs. OUTPUT VOLTAGE

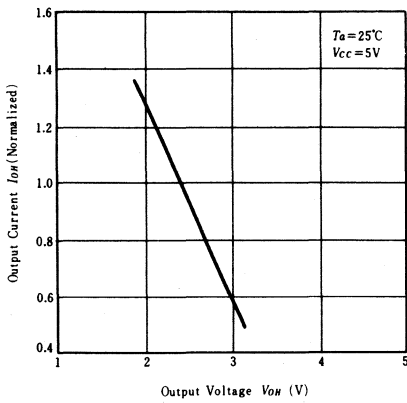

OUTPUT CURRENT vs. OUTPUT VOLTAGE

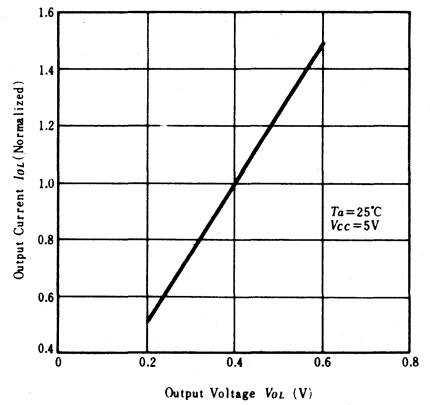

STANDBY CURRENT vs. AMBIENT TEMPERATURE

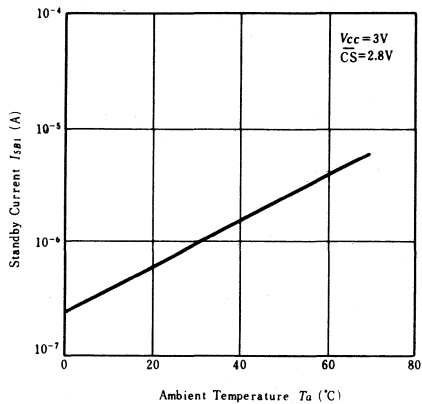

STANDBY CURRENT vs. SUPPLY VOLTAGE

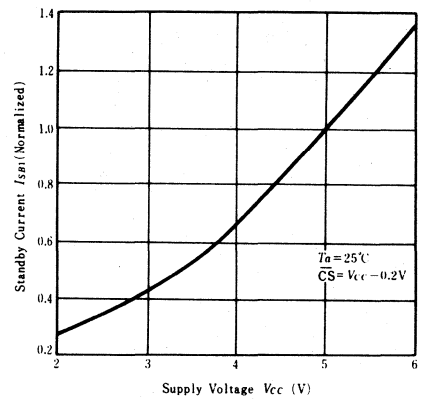

**STANDBY CURRENT vs.
INPUT VOLTAGE**

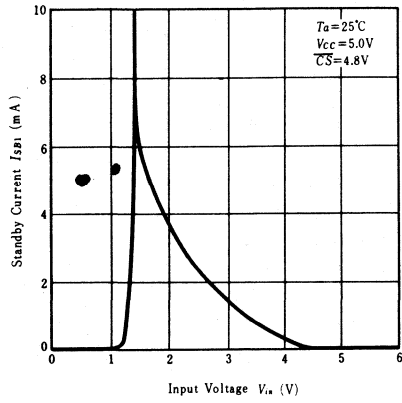

HM6116LI-2, HM6116LI-3, HM6116LI-4

— Wide Operating Temperature Range —

2048-word × 8-bit High Speed Static CMOS RAM

FEATURES

- Wide Operating Temperature Range -40~+85°C
- Single 5V Supply and High Density 24 Pin Package
- High Speed: Fast Access Time 120ns/150ns/200ns (max.)
- Low Power Standby and Standby: 20μW (typ.)
Low Power Operation; Operation: 160m W (typ.)
- Completely Static RAM: No clock nor Timing Strobe Required
- Directly TTL Compatible: All Input and Output
- Pin Out Compatible with Standard 16K EPROM/MASK ROM
- Equal Access and Cycle Time
- Capability of Battery Back up Operation

FUNCTIONAL BLOCK DIAGRAM

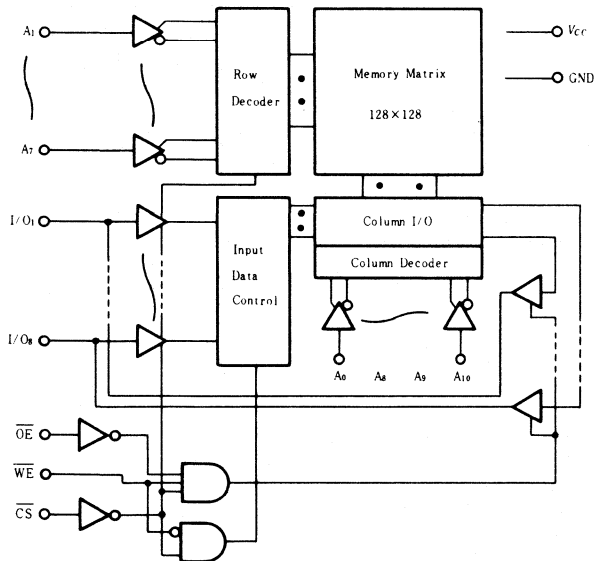

ABSOLUTE MAXIMUM RATINGS

Item	Symbol	Rating	Unit
Voltage on Any Pin Relative to GND	V_T	-0.5* to +7.0	V
Operating Temperature	T_{opr}	-40 to +85	°C
Storage Temperature	T_{stg}	-65 to +150	°C
Power Dissipation	P_T	1.0	W

* Pulse Width 50ns : - 1.5 V

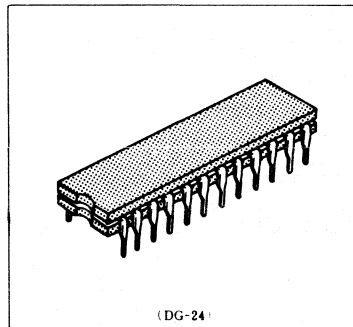

PIN ARRANGEMENT

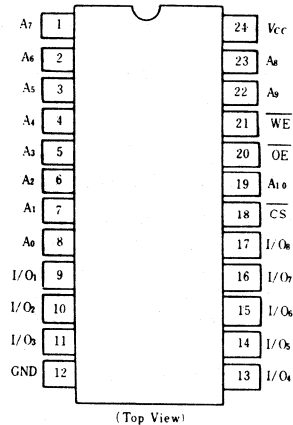

■ TRUTH TABLE

CS	OE	WE	Mode	V _{CC} Current	I/O Pin	Ref. Cycle
H	×	×	Not Selected	I _{SB} , I _{SB1}	High Z	
L	L	H	Read	I _{CC}	Dout	Read Cycle (1)~(3)
L	H	L	Write	I _{CC}	Din	Write Cycle (1)
L	L	L	Write	I _{CC}	Din	Write Cycle (2)

■ RECOMMENDED DC OPERATING CONDITIONS (T_a = -40 to +85°C)

Item	Symbol	min	typ	max	Unit
Supply Voltage	V _{CC}	4.5	5.0	5.5	V
	GND	0	0	0	V
Input Voltage	V _{IH}	2.2	3.5	6.0	V
	V _{IL}	-1.0*	—	0.8	V

* Pulse Width: 50ns, DC: V_{IL} min = -0.3V

■ DC AND OPERATING CHARACTERISTICS (V_{CC} = 5V ±10%, GND = 0V, T_a = -40 to +85°C)

Item	Symbol	Test Conditions	min	typ*	max	Unit
Input Leakage Current	I _{LI}	V _{CC} = 5.5V, V _{IN} = GND to V _{CC}	—	—	2	μA
Output Leakage Current	I _{LO}	CS = V _{IH} or OE = V _{IH} , V _{I/O} = GND to V _{CC}	—	—	2	μA
Operating Power Supply Current	I _{CC}	CS = V _{IL} , I _{I/O} = 0mA	—	35	90	mA
	I _{CC1} **	V _{IH} = 3.5V, V _{IL} = 0.6V, I _{I/O} = 0mA	—	30	—	mA
Average Operating Current	I _{CC2}	min. cycle, duty = 100%	—	35	90	mA
Standby Power Supply Current	I _{SB}	CS = V _{IH}	—	4	20	mA
	I _{SB1}	CS ≥ V _{CC} - 0.2V, V _{IN} ≥ V _{CC} - 0.2V or V _{IN} ≤ 0.2V	—	4	200	μA
Output Voltage	V _{OL}	I _{OL} = 2.1mA	—	—	0.4	V
	V _{OH}	I _{OH} = -1.0mA	2.4	—	—	V

* : V_{CC} = 5V, T_a = 25°C ** : Reference Only

■ AC CHARACTERISTICS (V_{CC} = 5V ±10%, T_a = -40 to +85°C)

● AC TEST CONDITIONS

Input Pulse Levels: 0.8 to 2.4V

Input Rise and Fall Times: 10 ns

Input and Output Timing Reference Levels: 1.5V

Output Load: 1TTL Gate and C_L = 100pF (including scope and jig)

● READ CYCLE

Item	Symbol	HM6116LI-2		HM6116LI-3		HM6116LI-4		Unit
		min	max	min	max	min	max	
Read Cycle Time	t _{RC}	120	—	150	—	200	—	ns
Address Access Time	t _{AA}	—	120	—	150	—	200	ns
Chip Select Access Time	t _{ACS}	—	120	—	150	—	200	ns
Chip Selection to Output in Low Z	t _{CLZ}	10	—	10	—	10	—	ns
Output Enable to Output Valid	t _{OE}	—	80	—	100	—	120	ns
Output Enable to Output in Low Z	t _{OLZ}	10	—	10	—	10	—	ns
Chip deselection to Output in High Z	t _{CHZ}	0	40	0	50	0	60	ns
Chip Disable to Output in High Z	t _{OHZ}	0	40	0	50	0	60	ns
Output Hold from Address Change	t _{OH}	10	—	10	—	10	—	ns

● WRITE CYCLE

Item	Symbol	HM6116LI-2		HM6116LI-3		HM6116LI-4		Unit
		min	max	min	max	min	max	
Write Cycle Time	t_{WC}	120	—	150	—	200	—	ns
Chip Selection to End of Write	t_{CW}	70	—	90	—	120	—	ns
Address Valid to End of Write	t_{AW}	105	—	120	—	140	—	ns
Address Set Up Time	t_{AS}	20	—	20	—	20	—	ns
Write Pulse Width	t_{WP}	70	—	90	—	120	—	ns
Write Recovery Time	t_{WR}	5	—	10	—	10	—	ns
Output Disable to Output in High Z	t_{OHZ}	0	40	0	50	0	60	ns
Write to Output in High Z	t_{WHZ}	0	50	0	60	0	60	ns
Data to Write Time Overlap	t_{DW}	35	—	40	—	60	—	ns
Data Hold from Write Time	t_{DH}	5	—	10	—	10	—	ns
Output Active from End of Write	t_{OW}	5	—	10	—	10	—	ns

■ CAPACITANCE ($f = 1\text{MHz}$, $T_a = 25^\circ\text{C}$)

Item	Symbol	Test Conditions	typ	max	Unit
Input Capacitance	C_{in}	$V_{in} = 0\text{V}$	3	5	pF
Input/Output Capacitance	$C_{I/O}$	$V_{I/O} = 0\text{V}$	5	7	pF

Note) This parameter is sampled and not 100% tested.

■ TIMING WAVEFORM

● Read Cycle (1) (1), (5)

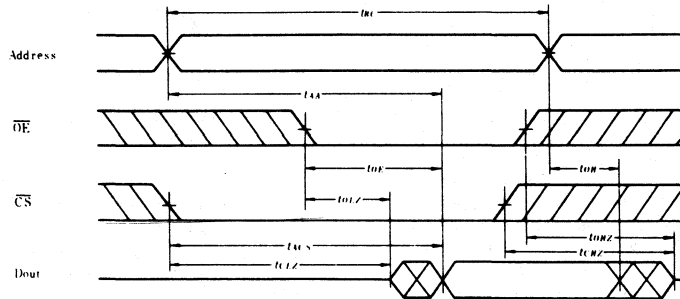

● Read Cycle (2) (1), (2), (4)

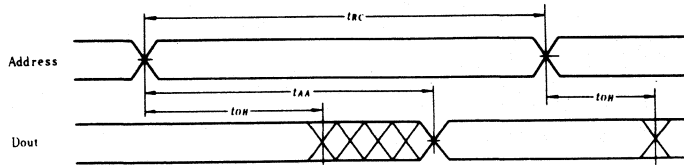

● Read Cycle (3) (1), (3), (4)

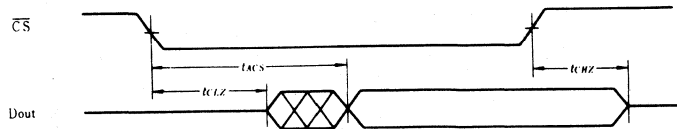

- NOTES: 1. \overline{WE} is High for Read Cycle.
 2. Device is continuously selected, $\overline{CS} = V_{IL}$.
 3. Address Valid prior to or coincident with \overline{CS} transition Low.
 4. $\overline{OE} = V_{IL}$.

● Write Cycle (1)

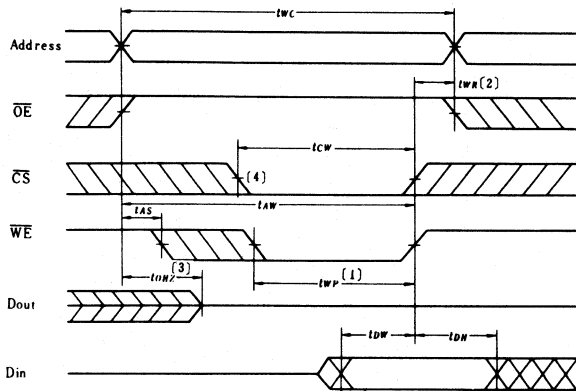

● Write Cycle (2)

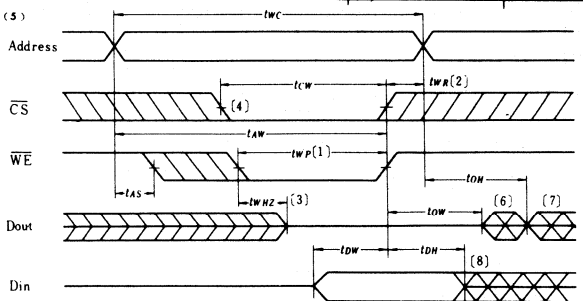

- NOTES: 1. A write occurs during the overlap (t_{WHP}) of a low \overline{CS} and a low \overline{WE} .
 2. t_{WR} is measured from the earlier of \overline{CS} or \overline{WE} going high to the end of write cycle.
 3. During this period, I/O pins are in the output state so that the input signals of opposite phase to the outputs must not be applied.
 4. If the \overline{CS} low transition occurs simultaneously with the \overline{WE} low transitions or after the \overline{WE}

- transition, output remain in a high impedance state.
 5. \overline{OE} is continuously low. ($\overline{OE} = V_{LL}$)
 6. D_{out} is the same phase of write data of this write cycle.
 7. D_{out} is the read data of next address.
 8. If \overline{CS} is Low during this period, I/O pins are in the output state. Then the data input signals of opposite phase to the outputs must not be applied to them.

■ LOW V_{CC} DATA RETENTION CHARACTERISTICS ($T_a = -40$ to $+85^\circ\text{C}$)

Item	Symbol	Test Conditions	min	typ	max	Unit
V_{CC} for Data Retention	V_{DR}	$\overline{CS} \geq V_{CC} - 0.2V$, $V_{i1} \geq V_{CC} - 0.2V$ or $V_{i1} \leq 0.2V$	2.0	—	—	V
Data Retention Current	I_{CCDR}^*	$V_{CC} = 3.0V$, $\overline{CS} \geq 2.8V$, $V_{i1} \geq 2.8V$ or $-0.3V \leq V_{i1} \leq 0.2V$	—	—	100	μA
Chip Deselect to Data Retention Time	t_{CDR}	See Retention Waveform	0	—	—	ns
Operation Recovery Time	t_R	See Retention Waveform	t_{RC}^{**}	—	—	ns

* $V_{i1} = -0.3V$ min. ** t_{RC} = Read Cycle Time.

● Low V_{CC} Data Retention Waveform

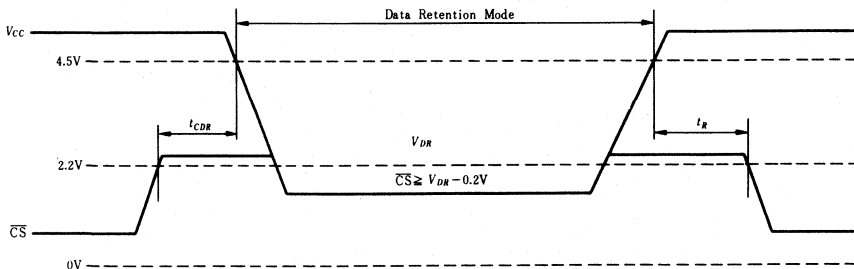

HM6116LP-2, HM6116LP-3, HM6116LP-4

2048-word × 8-bit High Speed Static CMOS RAM

■ FEATURES

- Single 5V Supply and High Density 24 Pin Package
- High Speed: Fast Access Time 120ns/150ns/200ns (max.)
- Low Power Standby and Standby: 10μW (typ.)
- Low Power Operation; Operation: 160mW (typ.)
- Completely Static RAM: No clock nor Timing Strobe Required
- Directly TTL Compatible: All Input and Output
- Pin Out Compatible with Standard 16K EPROM/MASK ROM
- Equal Access and Cycle Time
- Capability of Battery Back up Operation

■ FUNCTIONAL BLOCK DIAGRAM

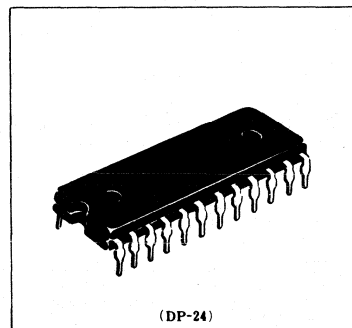
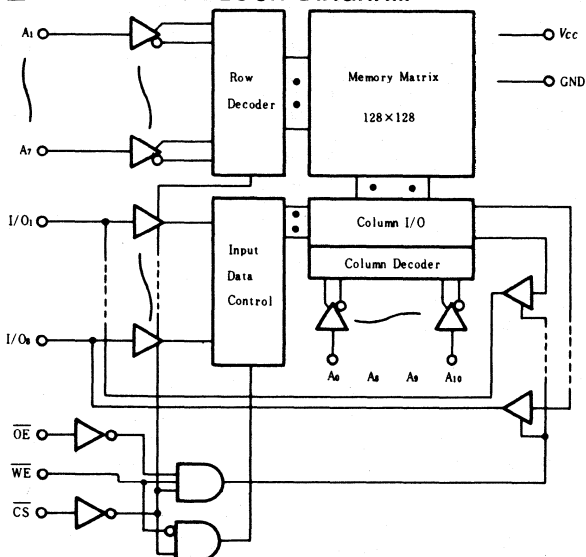

(DP-24)

■ PIN ARRANGEMENT

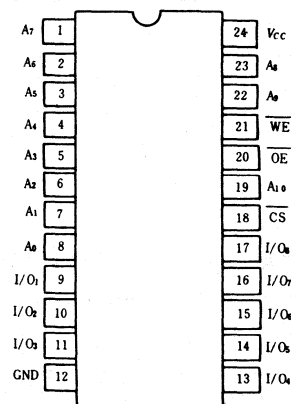

(Top View)

■ ABSOLUTE MAXIMUM RATINGS

Item	Symbol	Rating	Unit
Voltage on Any Pin Relative to GND	V_T	-0.5* to +7.0	V
Operating Temperature	T_{op}	0 to +70	°C
Storage Temperature	T_{stg}	-55 to +125	°C
Temperature Under Bias	T_{mb}	-10 to +85	°C
Power Dissipation	P_T	1.0	W

* Pulse Width 50ns : -1.5V

■ TRUTH TABLE

\overline{CS}	\overline{OE}	\overline{WE}	Mode	V_{cc} Current	I/O Pin	Ref. Cycle
H	×	×	Not Selected	I_{SB}, I_{SB1}	High Z	
L	L	H	Read	I_{cc}	Dout	Read Cycle (1)~(3)
L	H	L	Write	I_{cc}	Din	Write Cycle (1)
L	L	L	Write	I_{cc}	Din	Write Cycle (2)

RECOMMENDED DC OPERATING CONDITIONS ($T_a=0$ to $+70^\circ\text{C}$)

Item	Symbol	min			typ			max			Unit
Supply Voltage	V_{CC}	4.5			5.0			5.5			V
	GND	0			0			0			V
Input Voltage	V_{IH}	2.2			3.5			6.0			V
	V_{IL}	-1.0*			—			0.8			V

 * Pulse Width: 50ns, DC: V_{IL} min = -0.3V

DC AND OPERATING CHARACTERISTICS ($V_{CC}=5\text{V} \pm 10\%$, GND=0V, $T_a=0$ to $+70^\circ\text{C}$)

Item	Symbol	Test Conditions	HM6116LP-2			HM6116LP-3/-4			Unit
			min	typ*	max	min	typ*	max	
Input Leakage Current	$ I_{LI} $	$V_{CC}=5.5\text{V}$, $V_{in}=\text{GND to } V_{CC}$	—	—	2	—	—	2	μA
Output Leakage Current	$ I_{LO} $	$\overline{\text{CS}}=V_{IH}$ or $\overline{\text{OE}}=V_{IH}$, $V_{ILO}=\text{GND to } V_{CC}$	—	—	2	—	—	2	μA
Operating Power Supply Current	I_{CC}	$\overline{\text{CS}}=V_{IL}$, $I_{ILO}=0\text{mA}$	—	35	70	—	30	60	mA
	I_{CC1}^{**}	$V_{IH}=3.5\text{V}$, $V_{IL}=0.6\text{V}$, $I_{ILO}=0\text{mA}$	—	30	—	—	25	—	mA
Average Operating Current	I_{CC2}	min. cycle, duty = 100%	—	35	70	—	30	60	mA
Standby Power Supply Current	I_{SB}	$\overline{\text{CS}}=V_{IH}$	—	4	12	—	4	12	mA
	I_{SB1}	$\overline{\text{CS}} \geq V_{CC} - 0.2\text{V}$, $V_{in} \geq V_{CC} - 0.2\text{V}$ or $V_{in} \leq 0.2\text{V}$	—	2	50	—	2	50	μA
Output Voltage	V_{OL}	$I_{OL}=4\text{mA}$	—	—	0.4	—	—	—	V
		$I_{OL}=2.1\text{mA}$	—	—	—	—	—	0.4	V
	V_{OH}	$I_{OH}=-1.0\text{mA}$	2.4	—	—	2.4	—	—	V

 * : $V_{CC}=5\text{V}$, $T_a=25^\circ\text{C}$

** : Reference Only

AC CHARACTERISTICS ($V_{CC}=5\text{V} \pm 10\%$, $T_a=0$ to $+70^\circ\text{C}$)

AC TEST CONDITIONS

Input Pulse Levels: 0.8 to 2.4V

Input Rise and Fall Times: 10 ns

Input and Output Timing Reference Levels: 1.5V

 Output Load: 1TTL Gate and $C_L = 100\text{pF}$ (including scope and jig)

READ CYCLE

Item	Symbol	HM6116LP-2		HM6116LP-3		HM6116LP-4		Unit
		min	max	min	max	min	max	
Read Cycle Time	t_{RC}	120	—	150	—	200	—	ns
Address Access Time	t_{AA}	—	120	—	150	—	200	ns
Chip Select Access Time	t_{ACS}	—	120	—	150	—	200	ns
Chip Selection to Output in Low Z	t_{CLZ}	10	—	15	—	15	—	ns
Output Enable to Output Valid	t_{OE}	—	80	—	100	—	120	ns
Output Enable to Output in Low Z	t_{OLZ}	10	—	15	—	15	—	ns
Chip Deselection to Output in High Z	t_{CHZ}	0	40	0	50	0	60	ns
Chip Disable to Output in High Z	t_{OHZ}	0	40	0	50	0	60	ns
Output Hold from Address Change	t_{OH}	10	—	15	—	15	—	ns

● WRITE CYCLE

Item	Symbol	HM6116LP-2		HM6116LP-3		HM6116LP-4		Unit
		min	max	min	max	min	max	
Write Cycle Time	t_{WC}	120	—	150	—	200	—	ns
Chip Selection to End of Write	t_{CW}	70	—	90	—	120	—	ns
Address Valid to End of Write	t_{AW}	105	—	120	—	140	—	ns
Address Set Up Time	t_{AS}	20	—	20	—	20	—	ns
Write Pulse Width	t_{WP}	70	—	90	—	120	—	ns
Write Recovery Time	t_{WR}	5	—	10	—	10	—	ns
Output Disable to Output in High Z	t_{OHZ}	0	40	0	50	0	60	ns
Write to Output in High Z	t_{WHZ}	0	50	0	60	0	60	ns
Data to Write Time Overlap	t_{DW}	35	—	40	—	60	—	ns
Data Hold from Write Time	t_{DH}	5	—	10	—	10	—	ns
Output Active from End of Write	t_{OW}	5	—	10	—	10	—	ns

■ CAPACITANCE ($f=1\text{MHz}$, $T_a=25^\circ\text{C}$)

Item	Symbol	Test Conditions	typ	max	Unit
Input Capacitance	C_{iA}	$V_{iA} = 0\text{V}$	3	5	pF
Input/Output Capacitance	C_{iO}	$V_{iO} = 0\text{V}$	5	7	pF

Note) This parameter is sampled and not 100% tested.

■ TIMING WAVEFORM

● Read Cycle (1) ⁽¹⁾

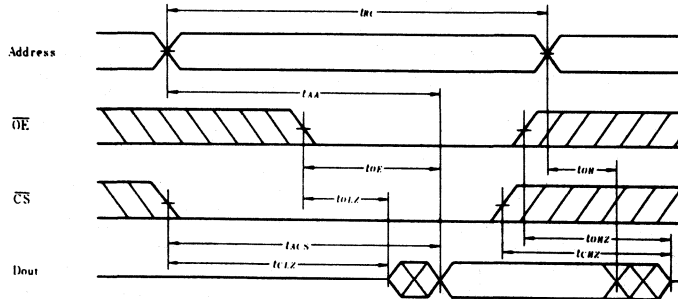

● Read Cycle (2) ^{(1), (2), (4)}

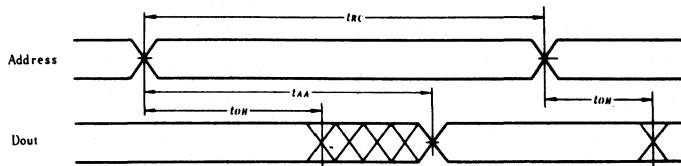

● Read Cycle (3) ^{(1), (3), (4)}

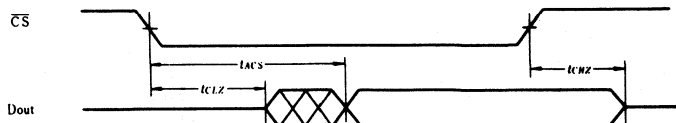

- NOTES: 1. \overline{OE} is High for Read Cycle.
 2. Device is continuously selected, $\overline{CS} = V_{IL}$.
 3. Address Valid prior to or coincident with \overline{CS} transition Low.
 4. $\overline{OE} = V_{IL}$.

● Write Cycle (1)

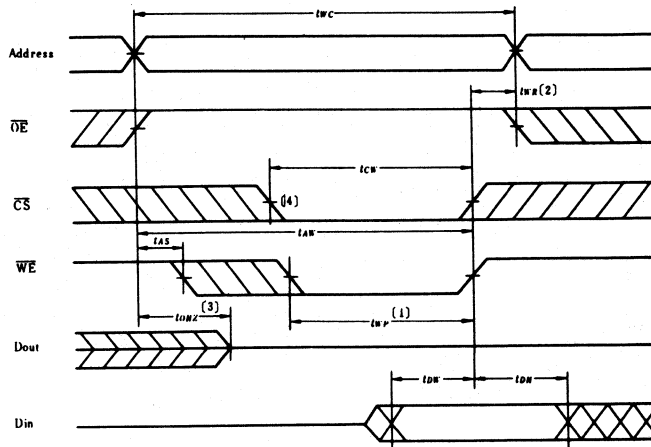

● Write Cycle (2)

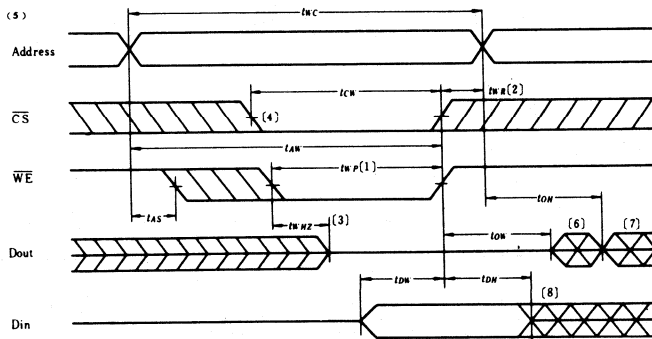

- NOTES: 1. A write occurs during the overlap (t_{WP}) of a low \overline{CS} and a low \overline{WE} .
 2. t_{WR} is measured from the earlier of \overline{CS} or \overline{WE} going high to the end of write cycle.
 3. During this period, I/O pins are in the output state so that the input signals of opposite phase to the outputs must not be applied.
 4. If the \overline{CS} low transition occurs simultaneously with the \overline{WE} low transitions or after the \overline{WE}

- transition, output remain in a high impedance state.
 5. \overline{OE} is continuously low. ($\overline{OE} = V_{IL}$)
 6. D_{out} is the same phase of write data of this write cycle.
 7. D_{out} is the read data of next address.
 8. If \overline{CS} is Low during this period, I/O pins are in the output state. Then the data input signals of opposite phase to the outputs must not be applied to them.

■ LOW V_{cc} DATA RETENTION CHARACTERISTICS ($T_a=0$ to $+70^\circ\text{C}$)

Item	Symbol	Test Conditions	min	typ	max	Unit
V_{cc} for Data Retention	V_{DR}	$\overline{CS} \geq V_{cc} - 0.2V, V_{i1} \geq V_{cc} - 0.2V$ or $V_{i1} \leq 0.2V$	2.0	—	—	V
Data Retention Current	I_{CCDR}^*	$V_{cc} = 3.0V, \overline{CS} \geq 2.8V, V_{i1} \geq 2.8V$ or $V_{i1} \leq 0.2V$	—	—	30	μA
Chip Deselect to Data Retention Time	t_{CDR}	See Retention Waveform	0	—	—	ns
Operation Recovery Time	t_R		t_{RC}^{**}	—	—	ns

* $10 \mu\text{A}$ max at $T_a=0^\circ\text{C}$ to $+40^\circ\text{C}$, V_{i1} min = $-0.3V$

** t_{RC} = Read Cycle Time.

● Low V_{cc} Data Retention Waveform

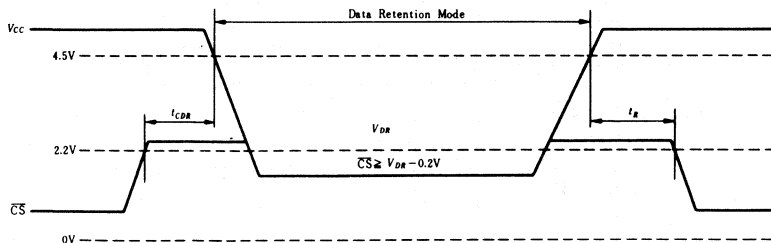

SUPPLY CURRENT vs. SUPPLY VOLTAGE

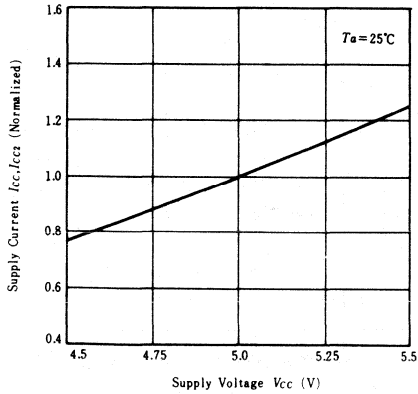

SUPPLY CURRENT vs. AMBIENT TEMPERATURE

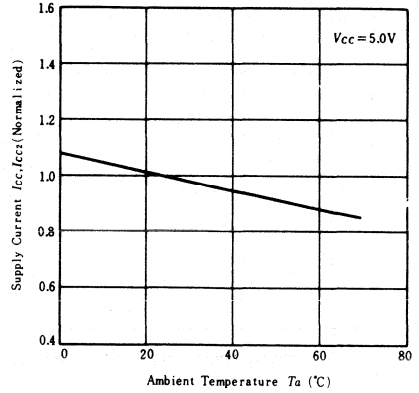

ACCESS TIME vs. SUPPLY VOLTAGE

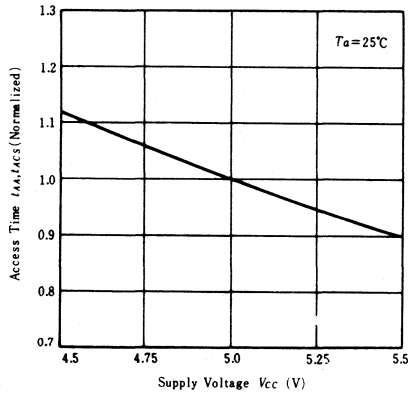

ACCESS TIME vs. AMBIENT TEMPERATURE

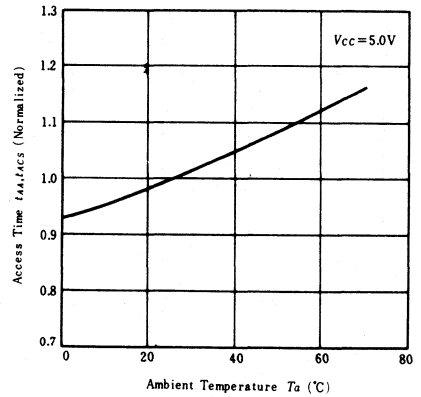

ACCESS TIME vs. LOAD CAPACITANCE

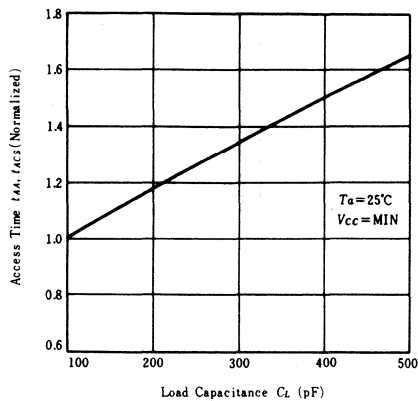

SUPPLY CURRENT vs. FREQUENCY

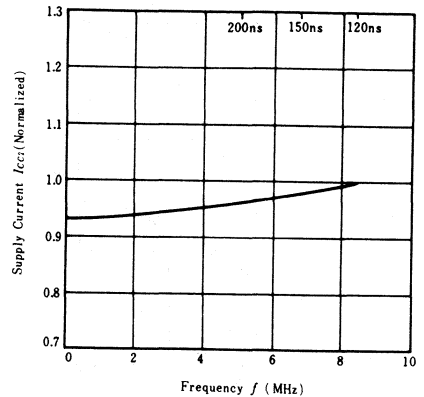

LOW INPUT VOLTAGE vs. SUPPLY VOLTAGE

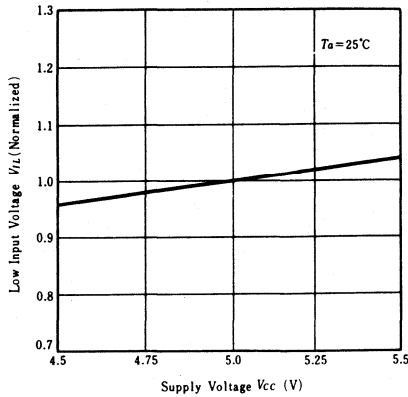

HIGH INPUT VOLTAGE vs. SUPPLY VOLTAGE

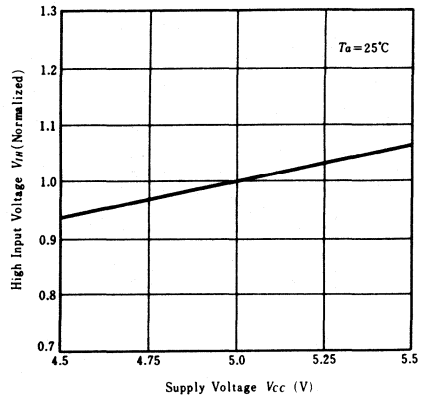

OUTPUT CURRENT vs. OUTPUT VOLTAGE

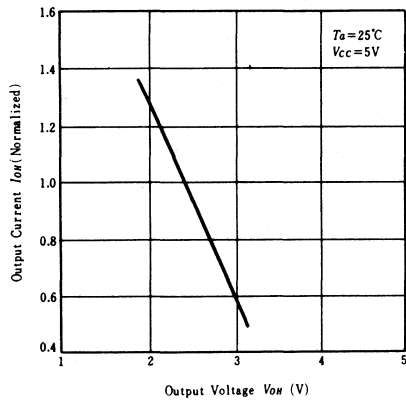

OUTPUT CURRENT vs. OUTPUT VOLTAGE

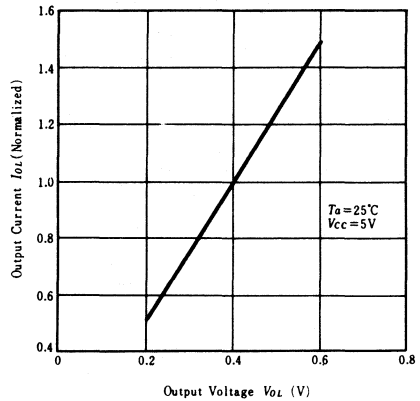

STANDBY CURRENT vs. AMBIENT TEMPERATURE

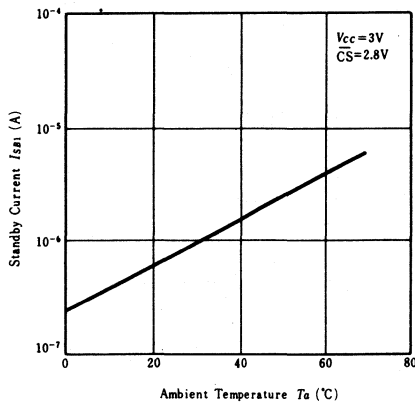

STANDBY CURRENT vs. SUPPLY VOLTAGE

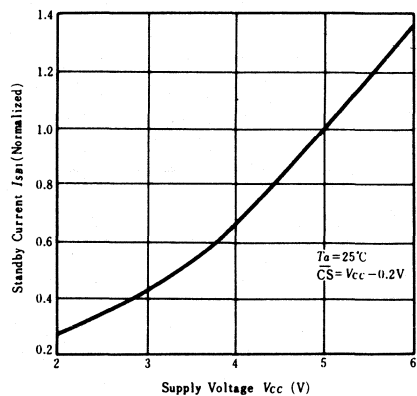

**STANDBY CURRENT vs.
INPUT VOLTAGE**

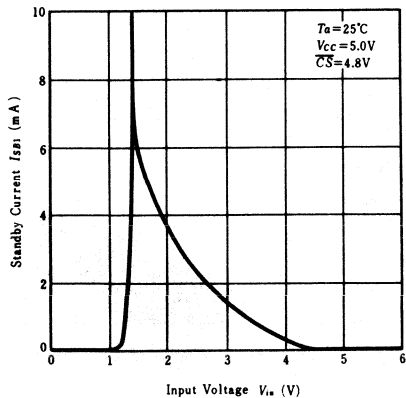

HM6116LPI-2, HM6116LPI-3, HM6116LPI-4 — Wide Operating Temperature Range —

2048-word × 8-bit High Speed Static CMOS RAM

■ FEATURES

- Wide Operating Temperature Range $-40 \sim +85^{\circ}\text{C}$
- Single 5V Supply and High Density 24 Pin Package
- High Speed: Fast Access Time 120ns/150ns/200ns (max.)
- Low Power Standby and Standby: $10\mu\text{W}$ (typ.)
Low Power Operation; Operation: 160mW (typ.)
- Completely Static RAM: No clock nor Timing Strobe Required
- Directly TTL Compatible: All Input and Output
- Pin Out Compatible with Standard 16K EPROM/MASK ROM
- Equal Access and Cycle Time
- Capability of Battery Back up Operation

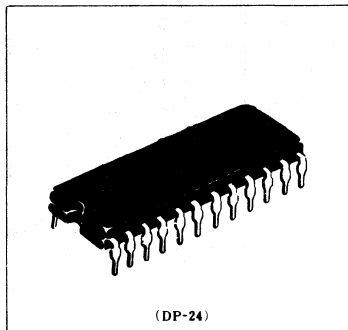

■ FUNCTIONAL BLOCK DIAGRAM

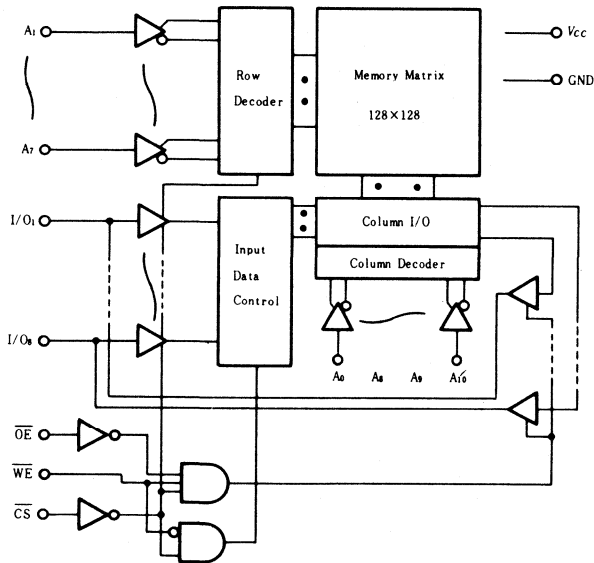

■ PIN ARRANGEMENT

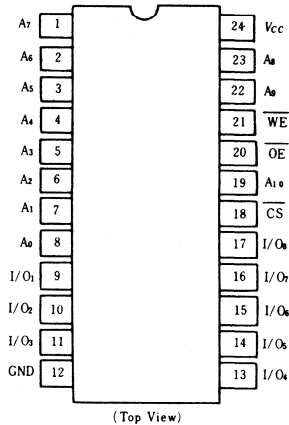

■ ABSOLUTE MAXIMUM RATINGS

Item	Symbol	Rating	Unit
Voltage on Any Pin Relative to GND	V_T	-0.5^* to $+7.0$	V
Operating Temperature	T_{opr}	-40 to $+85$	$^{\circ}\text{C}$
Storage Temperature	T_{stg}	-55 to $+125$	$^{\circ}\text{C}$
Power Dissipation	P_T	1.0	W

* Pulse Width 50ns : -1.5V

TRUTH TABLE

CS	OE	WE	Mode	V _{CC} Current	I/O Pin	Ref. Cycle
H	X	X	Not Selected	I _{SB} , I _{SB1}	High Z	
L	L	H	Read	I _{CC}	Dout	Read Cycle (1)~(3)
L	H	L	Write	I _{CC}	Din	Write Cycle (1)
L	L	L	Write	I _{CC}	Din	Write Cycle (2)

RECOMMENDED DC OPERATING CONDITIONS (T_a = -40 to +85°C)

Item	Symbol	min	typ	max	Unit
Supply Voltage	V _{CC}	4.5	5.0	5.5	V
	GND	0	0	0	V
Input Voltage	V _{IH}	2.2	3.5	6.0	V
	V _{IL}	-1.0*	—	0.8	V

* Pulse Width: 50ns, DC: V_{IL} min = -0.3V

DC AND OPERATING CHARACTERISTICS (V_{CC} = 5V ±10%, GND = 0V, T_a = -40 to +85°C)

Item	Symbol	Test Conditions	min	typ*	max	Unit
Input Leakage Current	I _{LI}	V _{CC} = 5.5V, V _{in} = GND to V _{CC}	—	—	2	μA
Output Leakage Current	I _{LO}	CS = V _{IH} or OE = V _{IH} , V _{I/O} = GND to V _{CC}	—	—	2	μA
Operating Power Supply Current	I _{CC}	CS = V _{IL} , I _{I/O} = 0mA	—	35	90	mA
	I _{CC1} **	V _{IH} = 3.5V, V _{IL} = 0.6V, I _{I/O} = 0mA	—	30	—	mA
Average Operating Current	I _{CC2}	min. cycle, duty = 100%	—	35	90	mA
Standby Power Supply Current	I _{SB}	CS = V _{IH}	—	4	20	mA
	I _{SB1}	CS ≥ V _{CC} - 0.2V, V _{in} ≥ V _{CC} - 0.2V or V _{in} ≤ 0.2V	—	2	100	μA
Output Voltage	V _{OL}	I _{OL} = 2.1mA	—	—	0.4	V
	V _{OH}	I _{OH} = -1.0mA	2.4	—	—	V

* : V_{CC} = 5V, T_a = 25°C

** : Reference Only

AC CHARACTERISTICS (V_{CC} = 5V ±10%, T_a = -40 to +85°C)

AC TEST CONDITIONS

Input Pulse Levels: 0.8 to 2.4V

Input Rise and Fall Times: 10 ns

Input and Output Timing Reference Levels: 1.5V

Output Load: 1TTL Gate and C_L = 100pF (including scope and jig)

READ CYCLE

Item	Symbol	HM6116LPI-2		HM6116LPI-3		HM6116LPI-4		Unit
		min	max	min	max	min	max	
Read Cycle Time	t _{RC}	120	—	150	—	200	—	ns
Address Access Time	t _{AA}	—	120	—	150	—	200	ns
Chip Select Access Time	t _{ACS}	—	120	—	150	—	200	ns
Chip Selection to Output in Low Z	t _{CLZ}	10	—	10	—	10	—	ns
Output Enable to Output Valid	t _{OE}	—	80	—	100	—	120	ns
Output Enable to Output in Low Z	t _{OLZ}	10	—	10	—	10	—	ns
Chip Deselection to Output in High Z	t _{CHZ}	0	40	0	50	0	60	ns
Chip Disable to Output in High Z	t _{ONZ}	0	40	0	50	0	60	ns
Output Hold from Address Change	t _{OH}	10	—	10	—	10	—	ns

● WRITE CYCLE

Item	Symbol	HM6116LPI-2		HM6116LPI-3		HM6116LPI-4		Unit
		min	max	min	max	min	max	
Write Cycle Time	t_{wc}	120	—	150	—	200	—	ns
Chip Selection to End of Write	t_{cw}	70	—	90	—	120	—	ns
Address Valid to End of Write	t_{aw}	105	—	120	—	140	—	ns
Address Set Up Time	t_{as}	20	—	20	—	20	—	ns
Write Pulse Width	t_{wp}	70	—	90	—	120	—	ns
Write Recovery Time	t_{wr}	5	—	10	—	10	—	ns
Output Disable to Output in High Z	t_{ohz}	0	40	0	50	0	60	ns
Write to Output in High Z	t_{whz}	0	50	0	60	0	60	ns
Data to Write Time Overlap	t_{dw}	35	—	40	—	60	—	ns
Data Hold from Write Time	t_{dh}	5	—	10	—	10	—	ns
Output Active from End of Write	t_{ow}	5	—	10	—	10	—	ns

■ CAPACITANCE ($f=1\text{MHz}$, $T_a=25^\circ\text{C}$)

Item	Symbol	Test Conditions	typ	max	Unit
Input Capacitance	$C_{i,a}$	$V_{i,a}=0\text{V}$	3	5	pF
Input/Output Capacitance	$C_{i,o}$	$V_{i,o}=0\text{V}$	5	7	pF

Note) This parameter is sampled and not 100% tested.

■ TIMING WAVEFORM

● Read Cycle (1) (1)

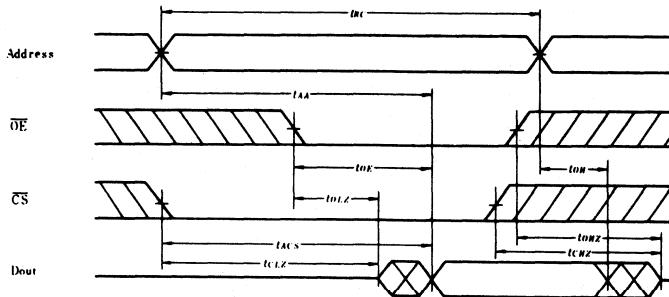

● Read Cycle (2) (1), (2), (4)

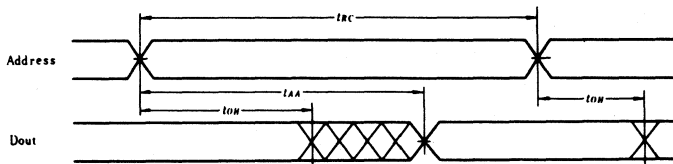

● Read Cycle (3) (1), (3), (4)

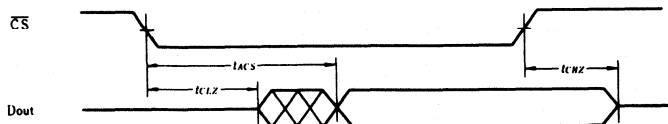

- NOTES: 1. \overline{WE} is High for Read Cycle.
 2. Device is continuously selected, $\overline{CS} = V_{IL}$.
 3. Address Valid prior to or coincident with \overline{CS} transition Low.
 4. $\overline{OE} = V_{IL}$.

● Write Cycle (1)

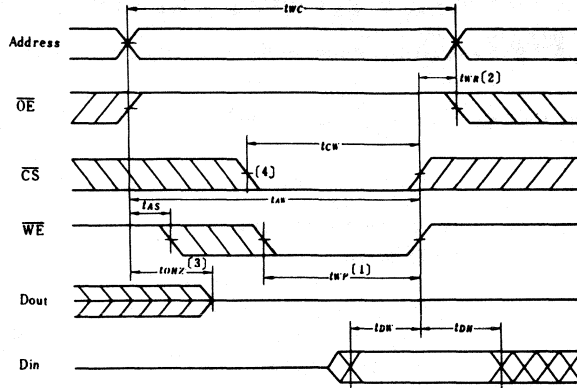

● Write Cycle (2)

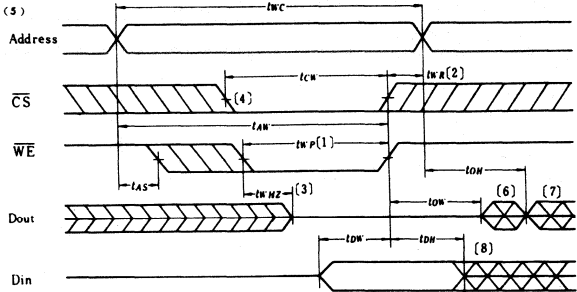

- NOTES: 1. A write occurs during the overlap (t_{WP}) of a low \overline{CS} and a low \overline{WE} .
 2. t_{WR} is measured from the earlier of \overline{CS} or \overline{WE} going high to the end of write cycle.
 3. During this period, I/O pins are in the output state so that the input signals of opposite phase to the outputs must not be applied.
 4. If the \overline{CS} low transition occurs simultaneously with the \overline{WE} low transitions or after the \overline{WE}

- transition, output remain in a high impedance state.
 5. \overline{OE} is continuously low. ($\overline{OE} = V_{IL}$)
 6. D_{out} is the same phase of write data of this write cycle.
 7. D_{out} is the read data of next address.
 8. If \overline{CS} is Low during this period, I/O pins are in the output state. Then the data input signals of opposite phase to the outputs must not be applied to them.

■ LOW V_{CC} DATA RETENTION CHARACTERISTICS ($T_a = -40$ to $+85^\circ\text{C}$)

Item	Symbol	Test Conditions	min	typ	max	Unit
V_{CC} for Data Retention	V_{DR}	$\overline{CS} \geq V_{CC} - 0.2\text{V}$, $V_{i.s} \geq V_{CC} - 0.2\text{V}$ or $V_{i.s} \leq 0.2\text{V}$	2.0	—	—	V
Data Retention Current	I_{CCDR}^*	$V_{CC} = 3.0\text{V}$, $\overline{CS} \geq 2.8\text{V}$, $V_{i.s} \geq 2.8\text{V}$ or $-0.3\text{V} \leq V_{i.s} \leq 0.2\text{V}$	—	—	50	μA
Chip Deselect to Data Retention Time	t_{CDR}	See Retention Waveform	0	—	—	ns
Operation Recovery Time	t_R		t_{RC}^{**}	—	—	ns

* 10 μA max at $T_a = -40^\circ\text{C}$ to $+40^\circ\text{C}$ V_{iL} min = -0.3V
 ** t_{RC} = Read Cycle Time.

● Low V_{CC} Data Retention Waveform

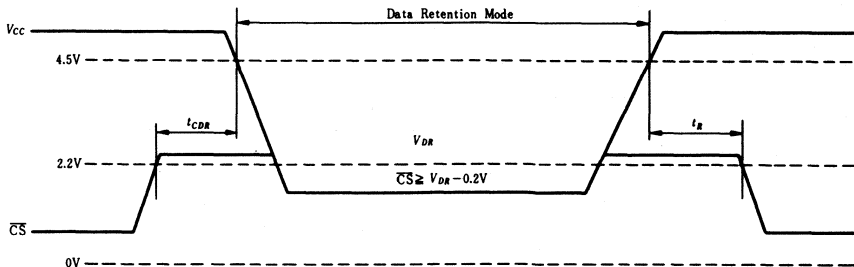

HM6116LFP-2, HM6116LFP-3, HM6116LFP-4

2048-word × 8-bit High Speed Static CMOS RAM

■ FEATURES

- High Density Small-sized Package
- Projection Area Reduced to One-Thirds of Conventional DIP
- Thickness Reduced to a Half of Conventional DIP
- Single 5V Supply
- High Speed: Fast Access Time 120ns/150ns/200ns (max.)
- Low Power Standby and Standby: 10μW (typ.)
- Low Power Operation; Operation: 160mW (typ.)
- Completely Static RAM: No Clock nor Timing Strobe Required
- Directly TTL Compatible: All Input and Output
- Equal Access and Cycle Time
- Capability of Battery Back up Operation

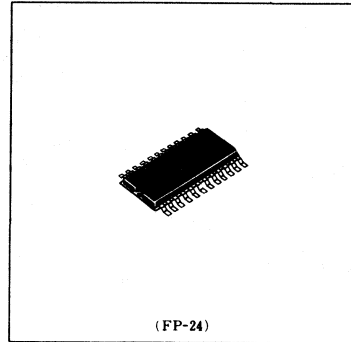

■ FUNCTIONAL BLOCK DIAGRAM

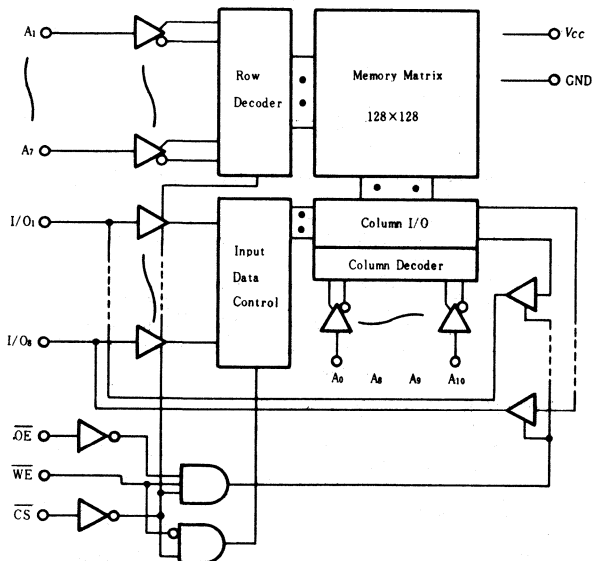

■ PIN ARRANGEMENT

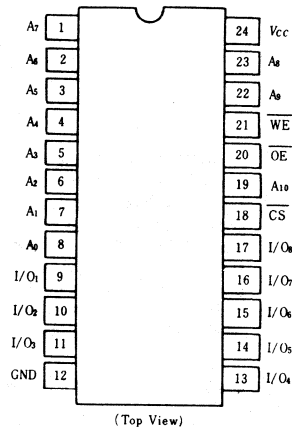

■ ABSOLUTE MAXIMUM RATINGS

Item	Symbol	Rating	Unit
Voltage on Any Pin Relative to GND	V_T	-0.5* to +7.0	V
Operating Temperature	T_{opr}	0 to +70	°C
Storage Temperature	T_{stg}	-55 to +125	°C
Temperature Under Bias	T_{bias}	-10 to +85	°C
Power Dissipation	P_T	1.0	W

* V_{IN} min = -1.5V (Pulse Width ≤ 50ns)

TRUTH TABLE

\overline{CS}	\overline{OE}	\overline{WE}	Mode	V_{CC} Current	I/O Pin	Ref. Cycle
H	X	X	Not Selected	I_{SB}, I_{SB1}	High Z	
L	L	H	Read	I_{CC}	Dout	Read Cycle (1)~(3)
L	H	L	Write	I_{CC}	Din	Write Cycle (1)
L	L	L	Write	I_{CC}	Din	Write Cycle (2)

RECOMMENDED DC OPERATING CONDITIONS ($T_a=0$ to $+70^\circ\text{C}$)

Item	Symbol	min	typ	max	Unit
Supply Voltage	V_{CC}	4.5	5.0	5.5	V
	GND	0	0	0	V
Input Voltage	V_{IH}	2.2	3.5	6.0	V
	V_{IL}	-1.0*	—	0.8	V

* Pulse Width : 50ns, DC : V_{IL} min = -0.3V.

DC AND OPERATING CHARACTERISTICS ($V_{CC}=5V\pm 10\%$, GND=0V, $T_a=0$ to $+70^\circ\text{C}$)

Item	Symbol	Test Conditions	HM6116LFP-2			HM6116LFP-3/-4			Unit
			min	typ*	max	min	typ*	max	
Input Leakage Current	$ I_{LI} $	$V_{CC}=5.5V$, $V_{i\alpha}=\text{GND to } V_{CC}$	—	—	2	—	—	2	μA
Output Leakage Current	$ I_{LO} $	$\overline{CS}=V_{IH}$ or $\overline{OE}=V_{IH}$, $V_{L\alpha}=\text{GND to } V_{CC}$	—	—	2	—	—	2	μA
Operating Power Supply Current	I_{CC}	$\overline{CS}=V_{IL}$, $I_{L\alpha}=0\text{mA}$	—	35	70	—	30	60	mA
	I_{CC1}^{**}	$V_{IH}=3.5V$, $V_{IL}=0.6V$, $I_{L\alpha}=0\text{mA}$	—	30	—	—	25	—	mA
Average Operating Current	I_{CC2}	Min cycle, duty=100%	—	35	70	—	30	60	mA
Standby Power Supply Current	I_{SB}	$\overline{CS}=V_{IH}$	—	4	12	—	4	12	mA
	I_{SB1}	$\overline{CS}\geq V_{CC}-0.2V$, $V_{i\alpha}\geq V_{CC}-0.2V$ or $V_{i\alpha}\leq 0.2V$	—	2	50	—	2	50	μA
Output Voltage	V_{OL}	$I_{OL}=4\text{mA}$	—	—	0.4	—	—	—	V
		$I_{OL}=2.1\text{mA}$	—	—	—	—	—	0.4	V
	V_{OH}	$I_{OH}=-1.0\text{mA}$	2.4	—	—	2.4	—	—	V

* : $V_{CC}=5V$, $T_a=25^\circ\text{C}$

** : Reference Only

AC CHARACTERISTICS ($V_{CC}=5V\pm 10\%$, $T_a=0$ to $+70^\circ\text{C}$)

AC TEST CONDITIONS

Input Pulse Levels: 0.8 to 2.4V

Input Rise and Fall Times: 10 ns

Input and Output Timing Reference Levels: 1.5V

Output Load: 1TTL Gate and $C_L = 100\text{pF}$ (including scope and jig)

READ CYCLE

Item	Symbol	HM6116LFP-2		HM6116LFP-3		HM6116LFP-4		Unit
		min	max	min	max	min	max	
Read Cycle Time	t_{RC}	120	—	150	—	200	—	ns
Address Access Time	t_{AA}	—	120	—	150	—	200	ns
Chip Select Access Time	t_{ACS}	—	120	—	150	—	200	ns
Chip Selection to Output in Low Z	t_{CLZ}	10	—	15	—	15	—	ns
Output Enable to Output Valid	t_{OE}	—	80	—	100	—	120	ns
Output Enable to Output in Low Z	t_{OLZ}	10	—	15	—	15	—	ns
Chip deselection to Output in High Z	t_{CHZ}	0	40	0	50	0	60	ns
Chip Disable to Output in High Z	t_{OHZ}	0	40	0	50	0	60	ns
Output Hold from Address Change	t_{OH}	10	—	15	—	15	—	ns

● WRITE CYCLE

Item	Symbol	HM6116LFP-2		HM6116LFP-3		HM6116LFP-4		Unit
		min	max	min	max	min	max	
Write Cycle Time	t_{wc}	120	—	150	—	200	—	ns
Chip Selection to End of Write	t_{cw}	70	—	90	—	120	—	ns
Address Valid to End of Write	t_{aw}	105	—	120	—	140	—	ns
Address Set Up Time	t_{as}	20	—	20	—	20	—	ns
Write Pulse Width	t_{wp}	70	—	90	—	120	—	ns
Write Recovery Time	t_{wr}	5	—	10	—	10	—	ns
Output Disable to Output in High Z	t_{onz}	0	40	0	50	0	60	ns
Write to Output in High Z	t_{whz}	0	50	0	60	0	60	ns
Data to Write Time Overlap	t_{dw}	35	—	40	—	60	—	ns
Data Hold from Write Time	t_{dh}	5	—	10	—	10	—	ns
Output Active from End of Write	t_{ow}	5	—	10	—	10	—	ns

■ CAPACITANCE ($f=1\text{MHz}$, $T_a=25^\circ\text{C}$)

Item	Symbol	Test Conditions	typ	max	Unit
Input Capacitance	C_{in}	$V_{in}=0\text{V}$	3	5	pF
Input/Output Capacitance	$C_{i/o}$	$V_{i/o}=0\text{V}$	5	7	pF

Note) This parameter is sampled and not 100% tested.

■ TIMING WAVEFORM

● READ CYCLE (1) ⁽¹⁾

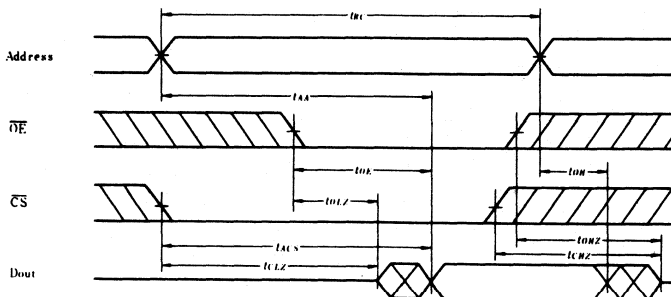

● READ CYCLE (3) ⁽¹⁾ (3) (4)

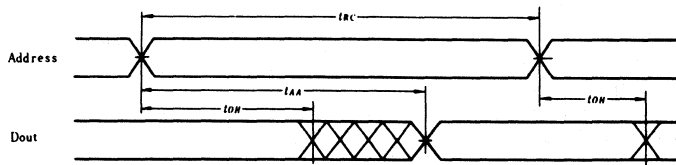

● READ CYCLE (2) ⁽¹⁾ (2) (4)

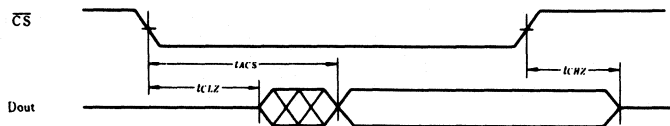

- NOTES: 1. \overline{WE} is High for Read Cycle
 2. Device is continuously selected, $\overline{CS} = V_{IL}$
 3. Address Valid prior to or coincident with \overline{CS} transition Low.
 4. $OE = V_{IL}$.

● WRITE CYCLE (1)

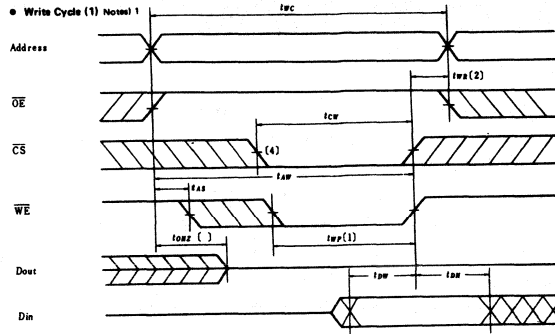

● WRITE CYCLE (2)

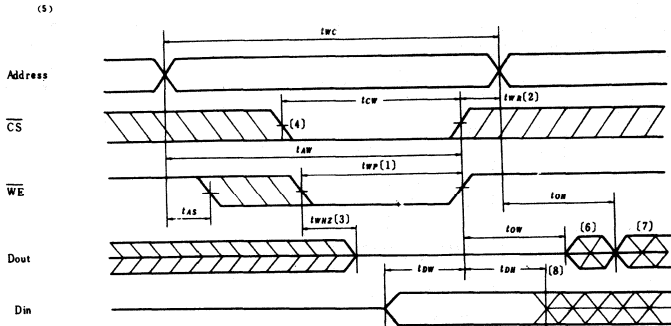

- NOTES: 1. A write occurs during the overlap (t_{WP}) of a low \overline{CS} and a low \overline{WE} .
 2. t_{WR} is measured from the earlier of \overline{CS} or \overline{WE} going high to the end of write cycle.
 3. During this period, I/O pins are in the output state so that the input signals of opposite phase to the outputs must not be applied.
 4. If the \overline{CS} low transition occurs simultaneously with the \overline{WE} low transitions or after the \overline{WE} transition, output remain in a high impedance state.
 5. \overline{OE} is continuously low. ($\overline{OE} = V_{IL}$)
 6. D_{out} is the same phase of write data of this write cycle.
 7. D_{out} is the read data of next address.
 8. If \overline{CS} is Low during this period, I/O pins are in the output state. Then the data input signals of opposite phase to the outputs must not be applied to them.

■ LOW V_{CC} DATA RETENTION CHARACTERISTICS ($T_a=0$ to $+70^\circ\text{C}$)

Item	Symbol	Test Conditions	min	typ	max	Unit
V_{CC} for Data Retention	V_{DR}	$\overline{CS} \geq V_{CC} - 0.2V$ $V_{IN} \geq V_{CC} - 0.2V$ or $V_{IN} \leq 0.2V$	2.0	—	—	V
Data Retention Current	I_{CCDR}^*	$V_{CC} = 3.0V$, $\overline{CS} \geq 2.8V$ $V_{IN} \geq 2.8V$ or $V_{IN} \leq 0.2V$	—	—	30	μA
Chip Deselect to Data Retention Time	t_{CDR}	See Retention Waveform	0	—	—	ns
Operation Recovery Time	t_R		** t_{RC}	—	—	ns

* V_{IL} min = $-0.3V$, $10\mu\text{A}$ max (at $T_a=0$ to $+40^\circ\text{C}$)
 ** t_{RC} - Read Cycle Time.

● Low V_{CC} DATA RETENTION WAVEFORM

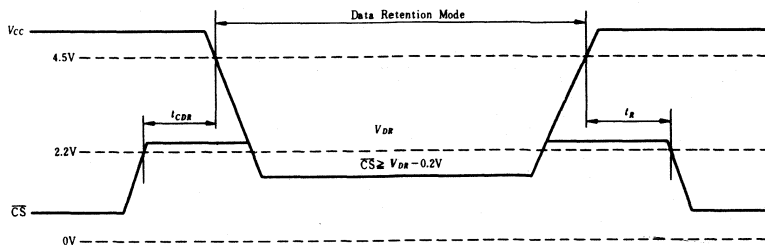

HM6116K-3, HM6116K-4

2048-word × 8-bit High Speed Static CMOS RAM

■ FEATURES

- Industrial Temperature Range 55 to +125°C
- Single 5V Supply and High Density 24 Pin Package
- High speed: Fast Access Time 150ns/200ns (max.)
- Low Power Standby and Standby: 100μW (type.)
Low Power Operation Operation: 180mW (typ.)
- Completely Static RAM: No clock or Timing Strobe Required
- Directly TTL Compatible: All Input and Output
- Pin Out Compatible with Standard 16K EPROM/MASK ROM
- Equal Access and Cycle Time

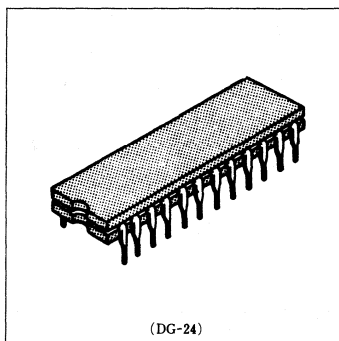

■ FUNCTIONAL BLOCK DIAGRAM

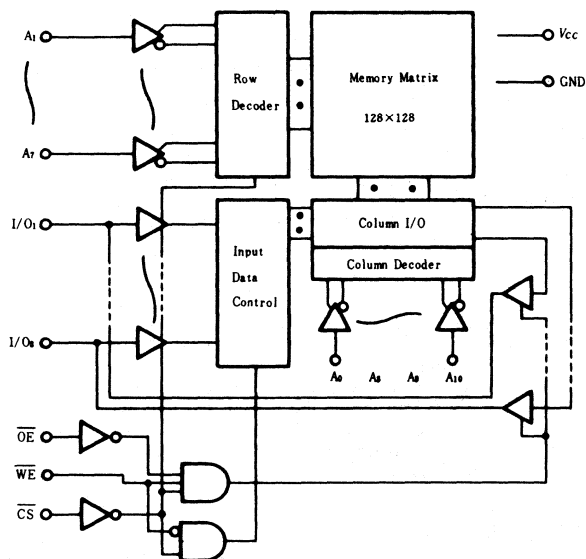

■ PIN ARRANGEMENT

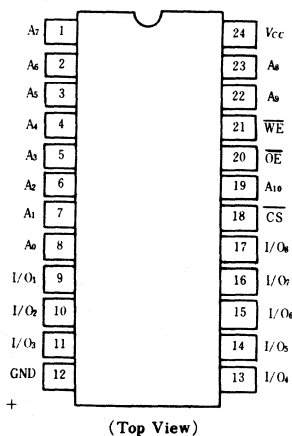

■ ABSOLUTE MAXIMUM RATINGS

Item	Symbol	Rating	Unit
Voltage on Any Pin Relative to GND	V_T	-0.5* to +7.0	V
Operating Temperature	T_{opr}	-55 to +125	°C
Storage Temperature	T_{stg}	-65 to +150	°C
Power Dissipation	P_T	1.0	W

* Pulse Width 50ns : -1.5V

■ TRUTH TABLE

\overline{CS}	\overline{OE}	\overline{WE}	Mode	V_{CC} Current	I/O Pin	Ref. Cycle
H	×	×	Not Selected	I_{SB}, I_{SB1}	High Z	
L	L	H	Read	I_{CC}	Dout	Read Cycle (1)~(3)
L	H	L	Write	I_{CC}	Din	Write Cycle (1)
L	L	L	Write	I_{CC}	Din	Write Cycle (2)

RECOMMENDED DC OPERATING CONDITIONS ($T_a=0$ to $+70^\circ\text{C}$)

Item	Symbol	min	typ	max	Unit
Supply Voltage	V_{CC}	4.5	5.0	5.5	V
	GND	0	0	0	V
Input Voltage	V_{IH}	2.2	3.5	6.0	V
	V_{IL}	-1.0*	—	0.8	V

* Pulse Width : 50ns, DC : $V_{IL\ min} = -0.3\text{V}$

DC AND OPERATING CHARACTERISTICS ($V_{CC}=5\text{V}\pm 10\%$, GND=0V, $T_a=-55\sim+125^\circ\text{C}$)

Item	Symbol	Test Conditions	min	typ*	max	Unit
Input Leakage Current	$ I_{LI} $	$V_{CC}=5.5\text{V}$, $V_{in}=\text{GND to } V_{CC}$	—	—	10	μA
Output Leakage Current	$ I_{LO} $	$\overline{\text{CS}}=V_{IH}$ or $\overline{\text{OE}}=V_{IH}$, $V_{I/O}=\text{GND to } V_{CC}$	—	—	10	μA
Operating Power Supply Current	I_{CC}	$\overline{\text{CS}}=V_{IL}$, $I_{I/O}=0\text{mA}$	—	35	90	mA
	I_{CC1}^{**}	$V_{IH}=3.5\text{V}$, $V_{IL}=0.6\text{V}$, $I_{I/O}=0\text{mA}$	—	30	—	mA
Average Operating Current	I_{CC2}	Min. cycle, duty=100%	—	35	90	mA
Standby Power Supply Current	I_{SB}	$\overline{\text{CS}}=V_{IH}$	—	4	20	mA
	I_{SB1}	$\text{CS}\geq V_{CC}-0.2\text{V}$, $V_{in}\geq V_{CC}$ -0.2V or $V_{in}\leq 0.2\text{V}$	—	0.02	2	mA
Output Voltage	V_{OL}	$I_{OL}=2.1\text{mA}$	—	—	0.4	V
	V_{OH}	$I_{OH}=-1.0\text{mA}$	2.4	—	—	V

* $V_{CC}=5\text{V}$, $T_a=25^\circ\text{C}$

** Reference Only

AC CHARACTERISTICS ($V_{CC}=5\text{V}\pm 10\%$, $T_a=-55$ to $+125^\circ\text{C}$)

AC TEST CONDITIONS

Input Pulse Levels: 0.8 to 2.4V

Input Rise and Fall Times: 10 ns

Input and Output Timing Reference Levels: 1.5V

Output Load: 1TTL Gate and $C_L = 100\text{pF}$ (including scope and jig)

READ CYCLE

Item	Symbol	HM6116K-3		HM6116K-4		Unit
		min	max	min	max	
Read Cycle Time	t_{RC}	150	—	200	—	ns
Address Access Time	t_{AA}	—	150	—	200	ns
Chip Select Access Time	t_{ACS}	—	150	—	200	ns
Chip Selection to Output in Low Z	t_{CLZ}	10	—	10	—	ns
Output Enable to Output Valid	t_{OE}	—	100	—	120	ns
Output Enable to Output in Low Z	t_{OLZ}	10	—	10	—	ns
Chip Deselection to Output in High Z	t_{CHZ}	0	50	0	60	ns
Chip Disable to Output in High Z	t_{OHZ}	0	50	0	60	ns
Output Hold from Address Change	t_{OH}	10	—	10	—	ns

● WRITE CYCLE

Item	Symbol	HM6116K-3		HM6116K-4		Unit
		min	max	min	max	
Write Cycle Time	t_{WC}	150	—	200	—	ns
Chip Selection to End of Write	t_{CW}	90	—	120	—	ns
Address Valid to End of Write	t_{AW}	120	—	140	—	ns
Address Set Up Time	t_{AS}	20	—	20	—	ns
Write Pulse Width	t_{WP}	90	—	120	—	ns
Write Recovery Time	t_{WR}	10	—	10	—	ns
Output Disable to Output in High Z	t_{OHZ}	0	50	0	60	ns
Write to Output in High Z	t_{WHZ}	0	60	0	60	ns
Data to Write Time Overlap	t_{DW}	40	—	60	—	ns
Data Hold from Write Time	t_{DH}	10	—	10	—	ns
Output Active from End of Write	t_{OW}	10	—	10	—	ns

■ CAPACITANCE ($f=1\text{MHz}$, $T_a=25^\circ\text{C}$)

Item	Symbol	Test Conditions	typ	max	Unit
Input Capacitance	C_{in}	$V_{in}=0\text{V}$	3	5	pF
Input/Output Capacitance	$C_{L/O}$	$V_{L/O}=0\text{V}$	5	7	pF

Note) This parameter is sampled and not 100% tested.

■ TIMING WAVEFORM

● READ CYCLE (1) ⁽¹⁾

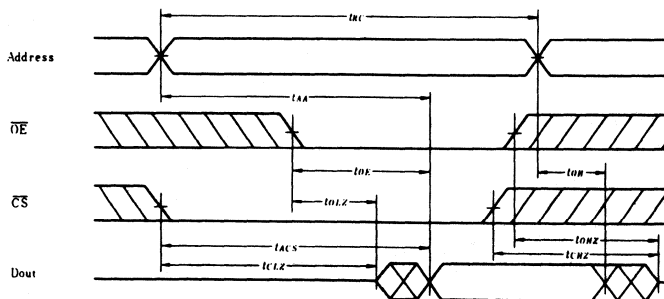

● READ CYCLE (2) ⁽¹⁾⁽²⁾⁽⁴⁾

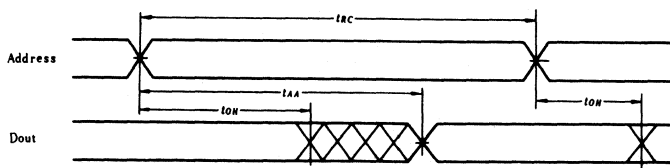

● READ CYCLE (3) ⁽¹⁾⁽³⁾⁽⁴⁾

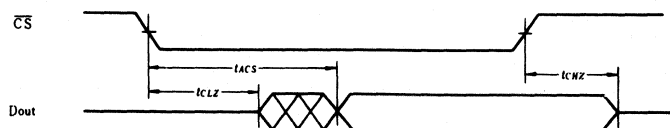

- NOTES: 1. \overline{OE} is High for Read Cycle.
 2. Device is continuously selected, $\overline{CS} = V_{IL}$.
 3. Address Valid prior to or coincident with \overline{CS} transition Low.
 4. $\overline{OE} = V_{IL}$.

WRITE CYCLE (1)

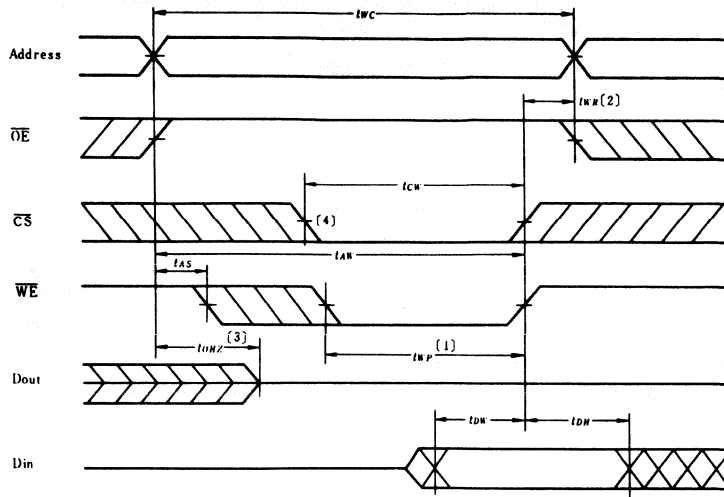
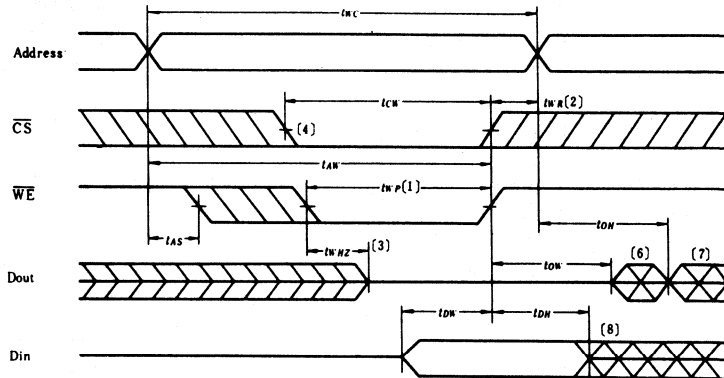
● WRITE CYCLE (2) ⁽⁵⁾

- NOTES:
1. A write occurs during the overlap (t_{WP}) of a low \overline{CS} and a low \overline{WE} .
 2. t_{WR} is measured from the earlier of \overline{CS} or \overline{WE} going high to the end of write cycle.
 3. During this period, I/O pins are in the output state so that the input signals of opposite phase to the outputs must not be applied.
 4. If the \overline{CS} low transition occurs simultaneously with the \overline{WE} low transitions or after the \overline{WE} transition, output remain in a high impedance state.
 5. \overline{OE} is continuously low. ($\overline{OE} = V_{IL}$)
 6. D_{out} is the same phase of write data of this write cycle.
 7. D_{out} is the read data of next address.
 8. If \overline{CS} is Low during this period, I/O pins are in the output state. Then the data input signals of opposite phase to the outputs must not be applied to them.

HM6116AP-10, HM6116AP-12, HM6116AP-15, HM6116AP-20, HM6116ASP-10, HM6116ASP-12, HM6116ASP-15, HM6116ASP-20

2048-word × 8-bit High Speed Static CMOS RAM

■ FURTURES

- High speed: Fast Access Time 100ns/120ns/150ns/200ns (max.)
- Low Power Standby and Standby: 100μW (typ.)
- Low Power Operation Operation: 15mW (typ.) (f = 1MHz)
- Single 5V Supply and High Density 24 Pin Package
- Completely Static RAM: No clock or Timing Strobe Required
- Directly TTL Compatible: All Input and Output
- Pin Out Compatible with Standard 16K EPROM/MASK ROM
- Equal Access and Cycle Time

■ FUNCTIONAL BLOCK DIAGRAM

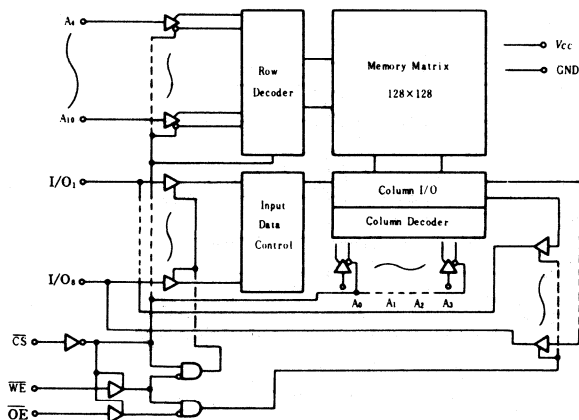

■ ABSOLUTE MAXIMUM RATINGS

Item	Symbol	Rating	Unit
Voltage on Any Pin Relative to GND	V_T	-0.5* to +7.0	V
Operating Temperature	T_{op}	0 to +70	°C
Storage Temperature	T_{stg}	-55 to +125	°C
Temperature Under Bias	T_{mb}	-10 to +85	°C
Power Dissipation	P_T	1.0	W

* Pulse Width 50ns : -1.5V

■ TRUTH TABLE

\overline{CS}	\overline{OE}	WE	Mode	V_{CC} Current	I/O Pin	Ref. Cycle
H	x	x	Not Selected	I_{SB}, I_{SB1}	High Z	
L	L	H	Read	I_{CC}	Dout	Read Cycle (1)~(3)
L	H	L	Write	I_{CC}	Din	Write Cycle (1)
L	L	L	Write	I_{CC}	Din	Write Cycle (2)

HM6116AP Series

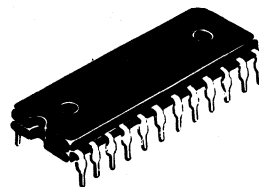

(DP-24)

HM6116ASP Series

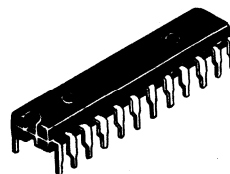

(DP-24A)

■ PIN ARRANGEMENT

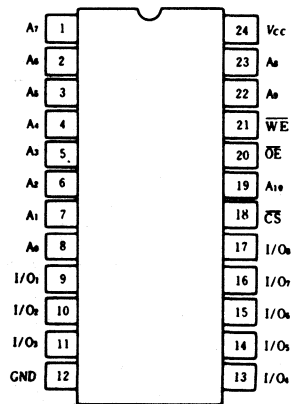

(Top View)

RECOMMENDED DC OPERATING CONDITIONS ($T_a=0$ to $+70^\circ\text{C}$)

Item	Symbol	min	typ	max	Unit
Supply Voltage	V_{CC}	4.5	5.0	5.5	V
	GND	0	0	0	V
Input Voltage	V_{IH}	2.2	3.5	6.0	V
	V_{IL}	-1.0*	—	0.8	V

* Pulse Width : 50ns, DC : $V_{IL\ min} = -0.3V$

DC AND OPERATING CHARACTERISTICS ($V_{CC}=5V \pm 10\%$, GND=0V, $T_a=0$ to $+70^\circ\text{C}$)

Item	Symbol	Test Conditions	HM6116AP/ASP-10			HM6116AP/ASP-12			HM6116AP/ASP-15			HM6116AP/ASP-20			Unit
			min	typ*	max	min	typ*	max	min	typ*	max	min	typ*	max	
Input Leakage Current	$ I_{LI} $	$V_{CC}=5.5V, V_{in}=\text{GND to } V_{CC}$	—	—	2	—	—	2	to	—	2	—	—	2	μA
Output Leakage Current	$ I_{LO} $	$\overline{CS}=V_{IH}$ or $\text{OE}=V_{IH}, V_{I/O}=\text{GND to } V_{CC}$	—	—	2	—	—	2	—	—	2	—	—	2	μA
Operating Power Supply Current	I_{CC}	$\overline{CS}=V_{IL}, I_{I/O}=0\text{mA}, V_{in}=V_{IH}$ or V_{IL}	—	5	15	—	5	15	—	5	15	—	5	15	mA
	I_{CC1}	$V_{IH}=V_{CC}, V_{IL}=0V, \overline{CS}=V_{IL}, I_{I/O}=0\text{mA}, f=1\text{MHz}$	—	3	6	—	3	6	—	3	6	—	3	6	mA
Average Operating Current	I_{CC2}	min. cycle, duty=100%	—	40	70	—	35	60	—	25	45	—	20	35	mA
Standby Power Supply Current	I_{SB}	$\overline{CS}=V_{IH}$	—	1	4	—	1	4	—	1	4	—	1	4	mA
	I_{SB1}	$\overline{CS} \geq V_{CC} - 0.2V$	—	0.02	2	—	0.02	2	—	0.02	2	—	0.02	2	mA
Output Voltage	V_{OL}	$I_{OL}=4\text{mA}$	—	—	0.4	—	—	0.4	—	—	0.4	—	—	0.4	V
	V_{OH}	$I_{OH}=-1.0\text{mA}$	2.4	—	—	2.4	—	—	2.4	—	—	2.4	—	—	V

* $V_{CC}=5V, T_a=25^\circ\text{C}$

AC CHARACTERISTICS ($V_{CC}=5V \pm 10\%$, $T_a=0$ to $+70^\circ\text{C}$)

AC TEST CONDITIONS

Input Pulse Levels: 0.8 to 2.4V

Input Rise and Fall Times: 10 ns

Input and Output Timing Reference Levels: 1.5V

Output Load: 1TTL Gate and $C_L = 100\text{pF}$ (including scope and jig)

READ CYCLE

Item	Symbol	HM6116AP/ASP-10		HM6116AP/ASP-12		HM6116AP/ASP-15		HM6116AP/ASP-20		Unit
		min	max	min	max	min	max	min	max	
Read Cycle Time	t_{RC}	100	—	120	—	150	—	200	—	ns
Address Access Time	t_{AA}	—	100	—	120	—	150	—	200	ns
Chip Select Access Time	t_{ACS}	—	100	—	120	—	150	—	200	ns
Chip Selection to Output in Low Z	t_{CLZ}	10	—	10	—	10	—	10	—	ns
Output Enable to Output Valid	t_{OE}	—	50	—	55	—	60	—	70	ns
Output Enable to Output in Low Z	t_{OLZ}	10	—	10	—	10	—	10	—	ns
Chip Deselection to Output in High Z	t_{CHZ}	0	40	0	40	0	50	0	60	ns
Chip Disable to Output in High Z	t_{OHZ}	0	40	0	40	0	50	0	60	ns
Output Hold from Address Change	t_{OH}	10	—	10	—	15	—	20	—	ns

● WRITE CYCLE

Item	Symbol	HM6116AP/ ASP-10		HM6116AP/ ASP-12		HM6116AP/ ASP-15		HM6116AP/ ASP-20		Unit
		min	max	min	max	min	max	min	max	
Write Cycle Time	t_{WC}	100	—	120	—	150	—	200	—	ns
Chip Selection to End of Write	t_{CW}	65	—	70	—	90	—	120	—	ns
Address Valid to End of Write	t_{AW}	80	—	105	—	120	—	140	—	ns
Address Set Up Time	t_{AS}	0	—	0	—	0	—	0	—	ns
Write Pulse Width	t_{WP}	60	—	70	—	80	—	100	—	ns
Write Recovery Time	t_{WR}	0	—	0	—	0	—	0	—	ns
Output Disable to Output in High Z	t_{OHZ}	0	40	0	40	0	50	0	60	ns
Write to Output in High Z	t_{WHZ}	0	30	0	35	0	40	0	50	ns
Data to Write Time Overlap	t_{DW}	30	—	35	—	40	—	50	—	ns
Data Hold from Write Time	t_{DH}	0	—	0	—	0	—	0	—	ns
Output Active from End of Write	t_{OW}	10	—	10	—	10	—	10	—	ns

■ CAPACITANCE ($f=1\text{MHz}$, $T_a=25^\circ\text{C}$)

Item	Symbol	Test Conditions	typ	max	Unit
Input Capacitance	$C_{i\bullet}$	$V_{i\bullet}=0\text{V}$	3	5	pF
Input/Output Capacitance	$C_{i/o}$	$V_{i/o}=0\text{V}$	5	7	pF

Note) This parameter is sampled and not 100% tested.

■ TIMING WAVEFORM

● READ CYCLE (1)⁽¹⁾

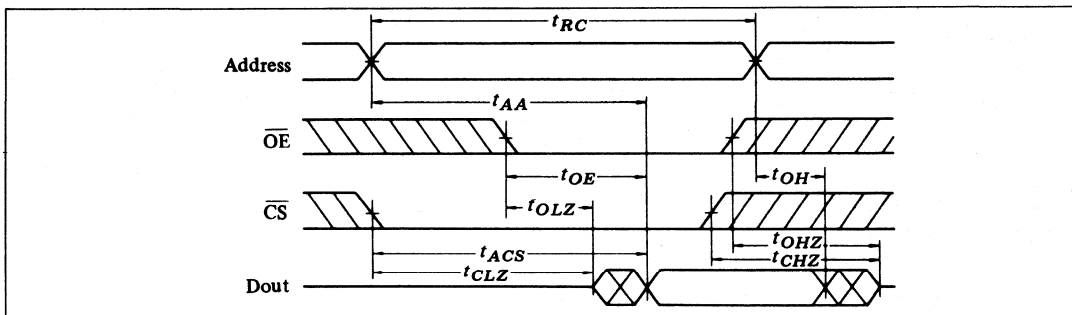

● READ CYCLE (2)⁽¹⁾⁽²⁾⁽⁴⁾

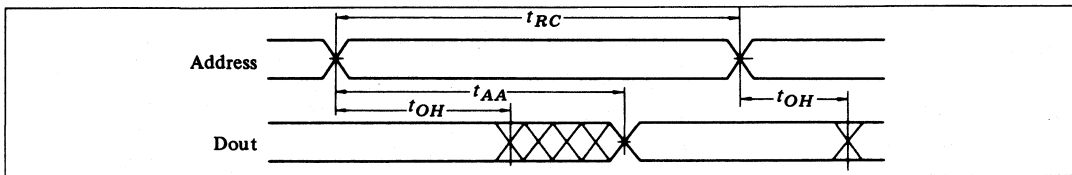

● READ CYCLE (3)⁽¹⁾⁽³⁾⁽⁴⁾

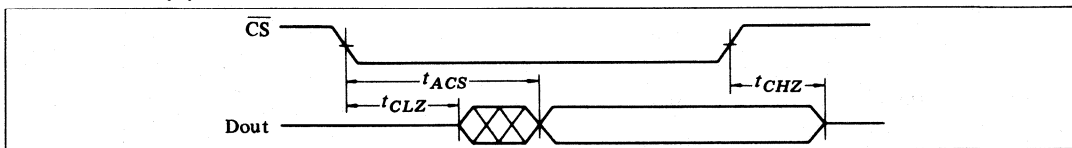

- NOTES: 1. \overline{WE} is High for Read Cycle.
 2. Device is continuously selected, $\overline{CS} = V_{IL}$.
 3. Address Valid prior to or coincident with \overline{CS} transition Low.
 4. $\overline{OE} = V_{IL}$.

● WRITE CYCLE(1)

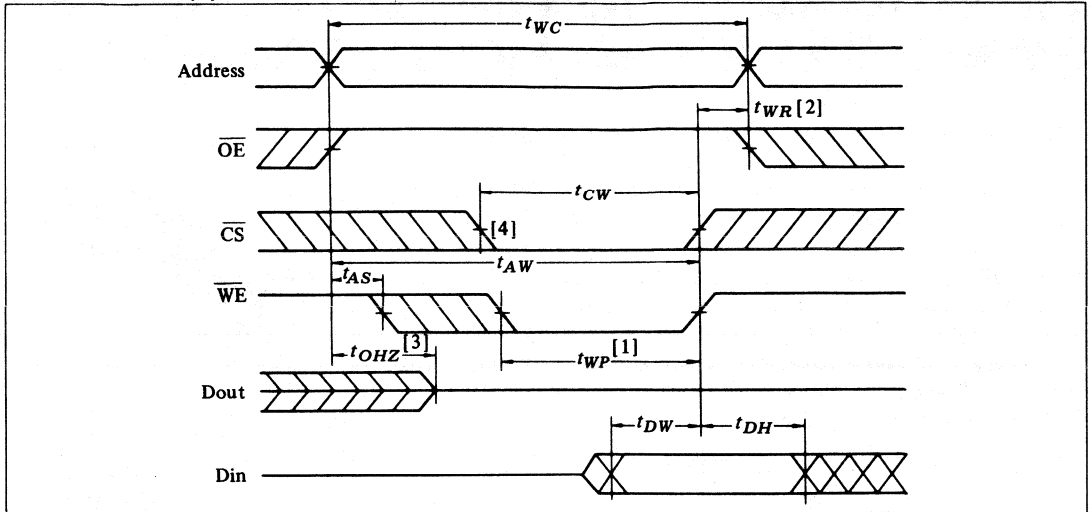

● WRITE CYCLE (2) ^(*)

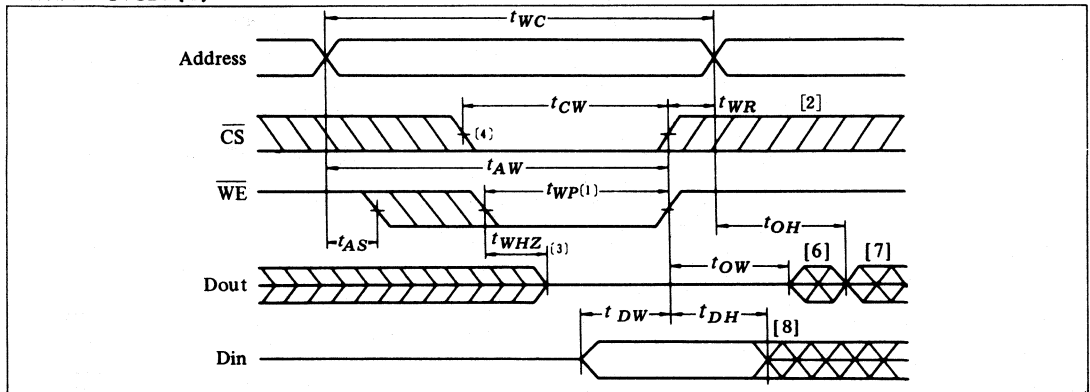

- NOTES:
1. A write occurs during the overlap (t_{WP}) of a low \overline{CS} and a low \overline{WE} .
 2. t_{WR} is measured from the earlier of \overline{CS} or \overline{WE} going high to the end of write cycle.
 3. During this period, I/O pins are in the output state so that the input signals of opposite phase to the outputs must not be applied.
 4. If the \overline{CS} low transition occurs simultaneously with the \overline{WE} low transitions or after the \overline{WE} transition, output remain in a high impedance state.
 5. \overline{OE} is continuously low. ($\overline{OE} = V_{IL}$)
 6. D_{out} is the same phase of write data of this write cycle.
 7. D_{out} is the read data of next address.
 8. If \overline{CS} is Low during this period, I/O pins are in the output state. Then the data input signals of opposite phase to the outputs must not be applied to them.

HM6116ALP-10, HM6116ALP-12, HM6116ALP-15, HM6116ALP-20, HM6116ALSP-10, HM6116ALSP-12, HM6116ALSP-15, HM6116ALSP-20

2048-word × 8-bit High Speed Static CMOS RAM

■ FEATURES

- High Speed: Fast Access Time 100ns/120ns/150ns/200ns (max.)
- Low Power Standby and Standby: 5μW (typ.)
- Low Power Operation; Operation: 10mW (typ.) (f = 1MHz)
- Capability of Battery Back up Operation
- Single 5V Supply and High Density 24 Pin Package
- Completely Static RAM: No clock nor Timing Strobe Required
- Directly TTL Compatible: All Input and Output
- Pin Out Compatible with Standard 16K EPROM/MASK ROM
- Equal Access and Cycle Time

■ FUNCTIONAL BLOCK DIAGRAM

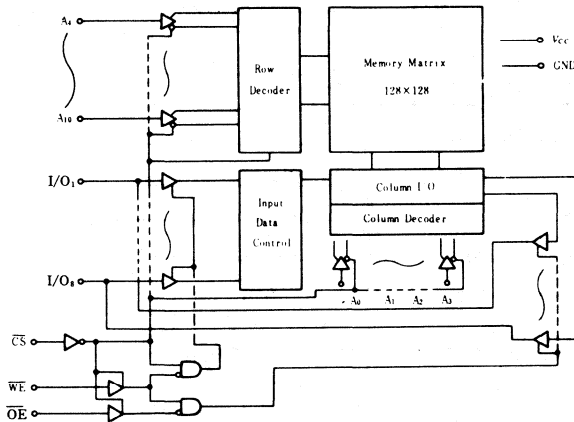

■ ABSOLUTE MAXIMUM RATINGS

Item	Symbol	Rating	Unit
Voltage on Any Pin Relative to GND	V_T	-0.5* to +7.0	V
Operating Temperature	T_{opr}	0 to +70	°C
Storage Temperature	T_{stg}	-55 to +125	°C
Temperature Under Bias	T_{mb}	-10 to +85	°C
Power Dissipation	P_T	1.0	W

* Pulse Width 50ns : -1.5V

■ TRUTH TABLE

\overline{CS}	\overline{OE}	\overline{WE}	Mode	V_{CC} Current	I/O Pin	Ref. Cycle
H	x	x	Not Selected	I_{SB}, I_{SB1}	High Z	
L	L	H	Read	I_{CC}	Dout	Read Cycle (1)~(3)
L	H	L	Write	I_{CC}	Din	Write Cycle (1)
L	L	L	Write	I_{CC}	Din	Write Cycle (2)

HM6116ALP Series

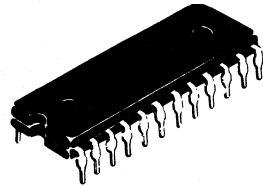

(DP-24)

HM6116ALSP Series

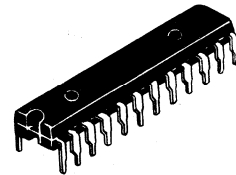

(DP-24A)

■ PIN ARRANGEMENT

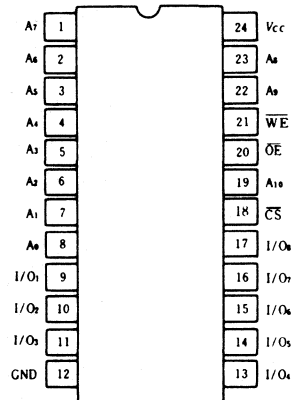

(Top View)

■ RECOMMENDED DC OPERATING CONDITIONS ($T_a=0$ to $+70^\circ\text{C}$)

Item	Symbol	min	typ	max	Unit
Supply Voltage	V_{CC}	4.5	5.0	5.5	V
	GND	0	0	0	V
Input Voltage	V_{IH}	2.2	3.5	6.0	V
	V_{IL}	-1.0*	—	0.8	V

* Pulse Width : 50ns, DC : V_{IL} min = -0.3V

■ DC AND OPERATING CHARACTERISTICS ($V_{CC}=5\text{V} \pm 10\%$, GND=0V, $T_a=0$ to $+70^\circ\text{C}$)

Item	Symbol	Test Conditions	HM6116ALP/ ALSP-10			HM6116ALP/ ALSP-12			HM6116ALP/ ALSP-15			HM6116ALP/ ALSP-20			Unit
			min	typ*	max	min	typ*	max	min	typ*	max	min	typ*	max	
Input Leakage Current	$ I_{LI} $	$V_{CC}=5.5\text{V}$, $V_{in}=\text{GND}$ to V_{CC}	—	—	2	—	—	2	—	—	2	—	—	2	μA
Output Leakage Current	$ I_{LO} $	$\overline{\text{CS}}=V_{IH}$ or $\overline{\text{OE}}=V_{IH}$, $V_{I/O}=\text{GND}$ to V_{CC}	—	—	2	—	—	2	—	—	2	—	—	2	μA
Operating Power Supply Current	I_{CC}	$\overline{\text{CS}}=V_{IL}$, $I_{I/O}=0\text{mA}$ $V_{in}=V_{IH}$ or V_{IL}	—	4	12	—	4	12	—	4	12	—	4	12	mA
	I_{CC1}	$V_{IH}=V_{CC}$, $V_{IL}=0\text{V}$, $\overline{\text{CS}}=V_{IL}$, $I_{I/O}=0\text{mA}$, $f=1\text{MHz}$	—	2	5	—	2	5	—	2	5	—	2	5	mA
Average Operating Current	I_{CC2}	min. cycle, duty=100%	—	35	60	—	30	50	—	20	40	—	15	30	mA
Standby Power Supply Current	I_{SB}	$\overline{\text{CS}}=V_{IH}$	—	0.5	3	—	0.5	3	—	0.5	3	—	0.5	3	mA
	I_{SB1}	$\overline{\text{CS}} \geq V_{CC} - 0.2\text{V}$	—	1	50	—	1	50	—	1	50	—	1	50	μA
Output Voltage	V_{OL}	$I_{OL}=4\text{mA}$	—	—	0.4	—	—	0.4	—	—	0.4	—	—	0.4	V
	V_{OH}	$I_{OH}=-1.0\text{mA}$	2.4	—	—	2.4	—	—	2.4	—	—	2.4	—	—	V

* : $V_{CC}=5\text{V}$, $T_a=25^\circ\text{C}$

■ AC CHARACTERISTICS ($V_{CC}=5\text{V} \pm 10\%$, $T_a=0$ to $+70^\circ\text{C}$)

● AC TEST CONDITIONS

Input Pulse Levels: 0.8 to 2.4V

Input Rise and Fall Times: 10 ns

Input and Output Timing Reference Levels: 1.5V

Output Load: 1TTL Gate and $C_L = 100\text{pF}$ (including scope and jig)

● READ CYCLE

Item	Symbol	HM6116ALP/ ALSP-10		HM6116ALP/ ALSP-12		HM6116ALP/ ALSP-15		HM6116ALP/ ALSP-20		Unit
		min	max	min	max	min	max	min	max	
Read Cycle Time	t_{RC}	100	—	120	—	150	—	200	—	ns
Address Access Time	t_{AA}	—	100	—	120	—	150	—	200	ns
Chip Select Access Time	t_{ACS}	—	100	—	120	—	150	—	200	ns
Chip Selection to Output in Low Z	t_{CLZ}	10	—	10	—	10	—	10	—	ns
Output Enable to Output Valid	t_{OE}	—	50	—	55	—	60	—	70	ns
Output Enable to Output in Low Z	t_{OLZ}	10	—	10	—	10	—	10	—	ns
Chip Deselection to Output in High Z	t_{CHZ}	0	40	0	40	0	50	0	60	ns
Chip Disable to Output in High Z	t_{OHZ}	0	40	0	40	0	50	0	60	ns
Output Hold from Address Change	t_{OH}	10	—	10	—	15	—	20	—	ns

● WRITE CYCLE

Item	Symbol	HM6116ALP/ ALSP-10		HM6116ALP/ ALSP-12		HM6116ALP/ ALSP-15		HM6116ALP/ ALSP-20		Unit
		min	max	min	max	min	max	min	max	
Write Cycle Time	t_{WC}	100	—	120	—	150	—	200	—	ns
Chip Selection to End of Write	t_{CW}	65	—	70	—	90	—	120	—	ns
Address Valid to End of Write	t_{AW}	80	—	105	—	120	—	140	—	ns
Address Set Up Time	t_{AS}	0	—	0	—	0	—	0	—	ns
Write Pulse Width	t_{WP}	60	—	70	—	80	—	100	—	ns
Write Recovery Time	t_{WR}	0	—	0	—	0	—	0	—	ns
Output Disable to Output in High Z	t_{OHZ}	0	40	0	40	0	50	0	60	ns
Write to Output in High Z	t_{WHZ}	0	30	0	35	0	40	0	50	ns
Data to Write Time Overlap	t_{DW}	30	—	35	—	40	—	50	—	ns
Data Hold from Write Time	t_{DH}	0	—	0	—	0	—	0	—	ns
Output Active from End of Write	t_{OW}	10	—	10	—	10	—	10	—	ns

■ CAPACITANCE ($f=1\text{MHz}$, $T_a=25^\circ\text{C}$)

Item	Symbol	Test Conditions	typ	max	Unit
Input Capacitance	C_{i1}	$V_{i1} = 0\text{V}$	3	5	pF
Input/Output Capacitance	$C_{i/o}$	$V_{i/o} = 0\text{V}$	5	7	pF

Note) This parameter is sampled and not 100% tested.

■ TIMING WAVEFORM

● Read Cycle (1)

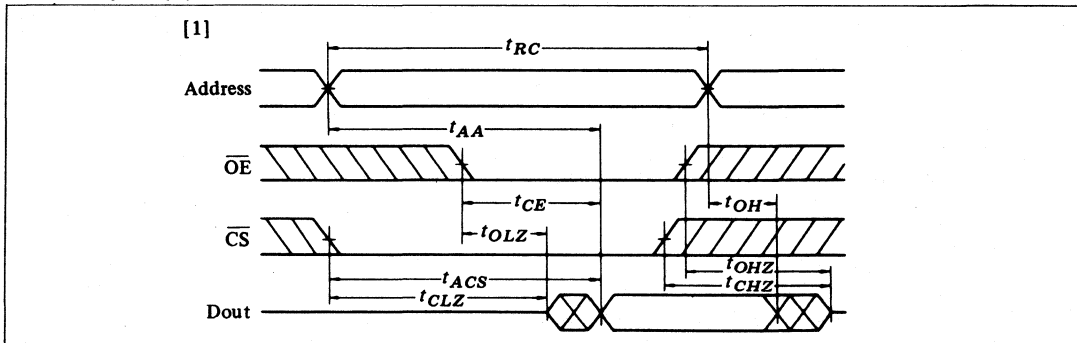

● Read Cycle (2)

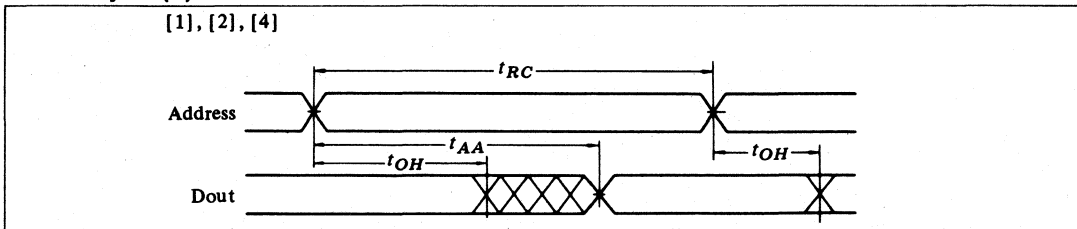

● Read Cycle (3)

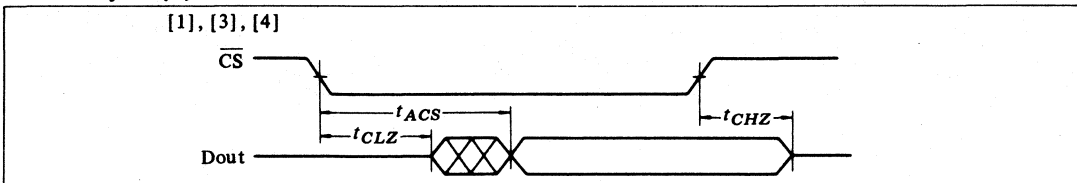

- NOTES: 1. \overline{WE} is High for Read Cycle.
 2. Device is continuously selected, $\overline{CS} = V_{IL}$.
 3. Address Valid prior to or coincident with \overline{CS} transition Low.
 4. $\overline{OE} = V_{IL}$.

● Write Cycle (1)

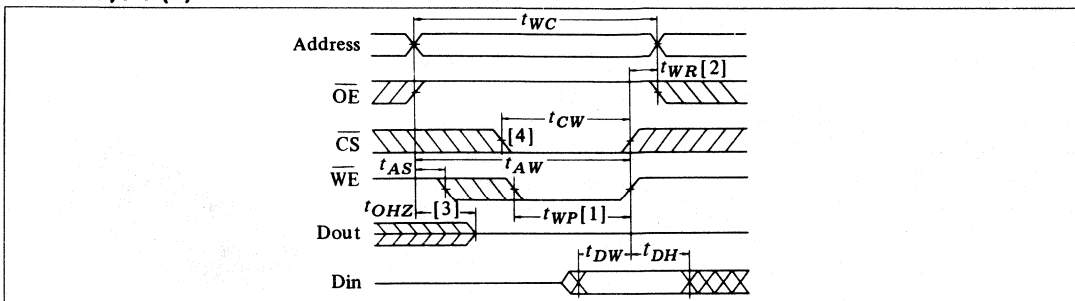

● Write Cycle (2)

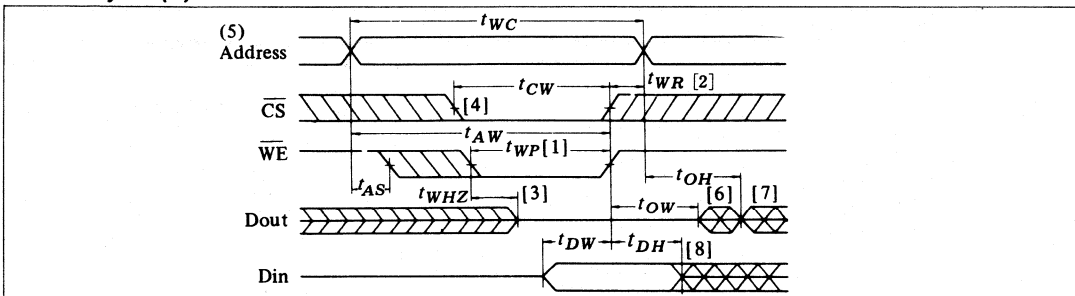

- NOTES: 1. A write occurs during the overlap (t_{WP}) of a low \overline{CS} and a low \overline{WE} .
 2. t_{WR} is measured from the earlier of \overline{CS} or \overline{WE} going high to the end of write cycle.
 3. During this period, I/O pins are in the output state so that the input signals of opposite phase to the outputs must not be applied.
 4. If the \overline{CS} low transition occurs simultaneously with the \overline{WE} low transitions or after the \overline{WE}

- transition, output remain in a high impedance state.
 5. \overline{OE} is continuously low. ($\overline{OE} = V_{IL}$)
 6. D_{out} is the same phase of write data of this write cycle.
 7. D_{out} is the read data of next address.
 8. If \overline{CS} is Low during this period, I/O pins are in the output state. Then the data input signals of opposite phase to the outputs must not be applied to them.

■ LOW V_{cc} DATA RETENTION CHARACTERISTICS ($T_a = 0$ to $+70^\circ\text{C}$)

Item	Symbol	Test Conditions	min	typ	max	Unit
V_{cc} for Data Retention	V_{DR}	$\overline{CS} \geq V_{cc} - 0.2V$	2.0	—	—	V
Data Retention Current	I_{CCDR}^*	$V_{cc} = 3.0V, \overline{CS} \geq 2.8V$	—	—	30	μA
Chip Deselect to Data Retention Time	t_{CDR}	See Retention Waveform	0	—	—	ns
Operation Recovery Time	t_R		t_{RC}^{**}	—	—	ns

* $10 \mu A$ max at $T_a = 0^\circ\text{C}$ to $+40^\circ\text{C}$. V_{IL} min = $-0.3V$

** t_R = Read Cycle Time.

● Low V_{cc} Data Retention Waveform

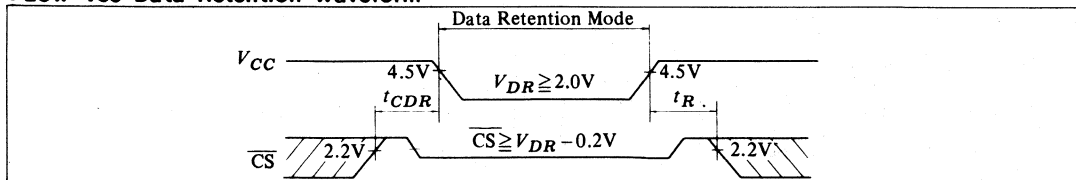

HM6117P-3, HM6117P-4

2048-word × 8-bit High Speed Static CMOS RAM

FEATURES

- Single 5V Supply and High Density 24 pin Package.
- High Speed: Fast Access Time 150ns/200ns (max.)
- Low Power Standby and Standby: 100μW (typ.)
- Low Power Operation: Operation: 200mW (typ.)
- Completely Static RAM: No clock nor Timing Strobe Required
- Directly TTL Compatible: All Input and Output
- Equal Access and Cycle Time

FUNCTIONAL BLOCK DIAGRAM

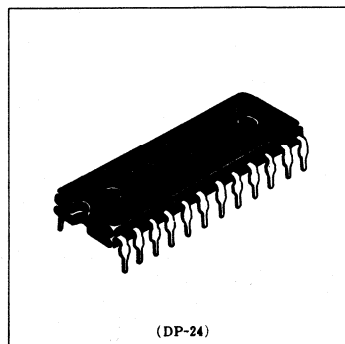
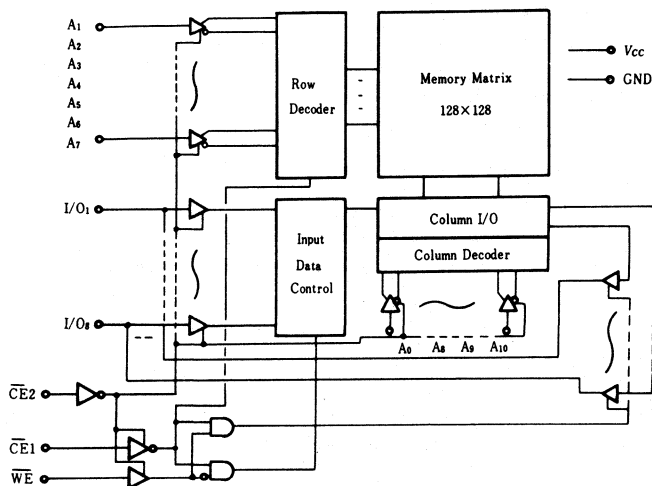

PIN ARRANGEMENT

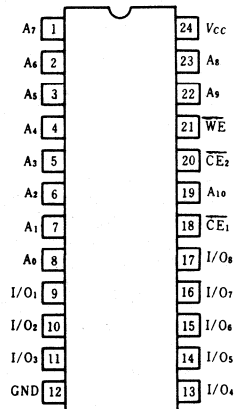

(Top View)

ABSOLUTE MAXIMUM RATINGS

Item	Symbol	Rating	Unit
Voltage on Any Pin Relative to GND	V_T	*-0.5 to +7.0	V
Power Dissipation	P_T	1.0	W
Operating Temperature	T_{opr}	0 to +70	°C
Storage Temperature	T_{stg}	-55 to +125	°C
Temperature Under Bias	T_{smb}	-10 to +85	°C

* Pulse width 50ns: -1.5V

TRUTH TABLE

$\overline{CE1}$	$\overline{CE2}$	\overline{WE}	Mode	V_{CC} Current	I/O Pin
H	×	×	Not Selected	I_{ccl1}	High Z
×	H	×	Not Selected	I_{ccl2}	High Z
L	L	H	Read	I_{cc}	Dout
L	L	L	Write	I_{cc}	Din

RECOMMENDED DC OPERATING CONDITIONS ($0^{\circ}\text{C} \leq T_a \leq 70^{\circ}\text{C}$)

Item	Symbol	min	typ	max	Unit
Supply Voltage	V_{CC}	4.5	5.0	5.5	V
	GND	0	0	0	V
Input High (logic 1) Voltage	V_{IH}	2.2	3.5	6.0	V
Input Low (logic 0) Voltage	V_{IL}	-1.0*	—	0.8	V

* Pulse width : 50ns, DC : $V_{ILmin} = -0.3\text{V}$

DC AND OPERATING CHARACTERISTICS ($T_a = 0^{\circ}\text{C}$ to $+70^{\circ}\text{C}$, $V_{CC} = 5\text{V} \pm 10\%$, GND = 0V)

Item	Symbol	Test Conditions	min	typ	max	Unit
Input Leakage Current	$ I_{LI} $	$V_{in} = \text{GND to } V_{CC}$	—	—	10	μA
Output Leakage Current	$ I_{LO} $	$\overline{CE}_1 = V_{IH}$ or $\overline{CE}_2 = V_{IH}$ $V_{I,o} = \text{GND to } V_{CC}$	—	—	10	μA
Operating Power Supply Current : DC	I_{CC}	$\overline{CE}_1 = \overline{CE}_2 = V_{IL}$, $I_{I,o} = 0\text{mA}$	—	40	80	mA
Average Operating Current	I_{CC1}	Min cycle, duty=100% $\overline{CE}_1 = V_{IL}$, $\overline{CE}_2 = V_{IL}$	—	40	80	mA
Standby Power Supply Current (1) : DC	I_{CC1}^*	$\overline{CE}_1 \geq V_{CC} - 0.2\text{V}$, $V_{IN} \geq V_{CC} - 0.2\text{V}$ or $V_{IN} \leq 0.2\text{V}$	—	0.02	2	mA
Standby Power Supply Current (2) : DC	I_{CC2}^*	$\overline{CE}_2 \geq V_{CC} - 0.2\text{V}$	—	0.02	2	mA
Output low Voltage	V_{OL}	$I_{OL} = 2.1\text{mA}$	—	—	0.4	V
Output High Voltage	V_{OH}	$I_{OH} = -1.0\text{mA}$	2.4	—	—	V

Notes : 1) Typical limits are at $V_{CC} = 5.0\text{V}$, $T_a = +25^{\circ}\text{C}$

2) * : $V_{ILmin} = -0.3\text{V}$

CAPACITANCE ($T_a = 25^{\circ}\text{C}$, $f = 1.0\text{MHz}$)

Item	Symbol	Test Conditions	typ	max	Unit
Input Capacitance	C_{IN}	$V_{IN} = 0\text{V}$	3	5	pF
Input/Output Capacitance	$C_{I,o}$	$V_{I,o} = 0\text{V}$	5	7	pF

Note) This parameter is sampled and not 100% tested.

AC CHARACTERISTICS ($T_a = 0^{\circ}\text{C}$ to $+70^{\circ}\text{C}$, $V_{CC} = 5\text{V} \pm 10\%$ unless otherwise noted)

AC TEST CONDITIONS

Input Pulse Levels: 0.8 to 2.4V

Input Rise and Fall Times: 10 ns

Input and Output Timing Reference Levels: 1.5V

Output Load: 1 TTL Gate and $C_L = 100\text{pF}$ (including scope and jig)

READ CYCLE

Item	Symbol	HM6117P-3		HM6117P-4		Unit
		min	max	min	max	
Read Cycle Time	t_{RC}	150	—	200	—	ns
Address Access Time	t_{AA}	—	150	—	200	ns
Chip Enable (\overline{CE}_1) to Output	t_{CO1}	—	150	—	200	ns
Chip Enable (\overline{CE}_2) to Output	t_{CO2}	—	150	—	200	ns
Chip Enable (\overline{CE}_1) to Output in Low Z	t_{LZ1}	10	—	10	—	ns
Chip Enable (\overline{CE}_2) to Output in Low Z	t_{LZ2}	10	—	10	—	ns
Chip Disable (\overline{CE}_1) to Output in High Z	t_{HZ1}	0	70	0	80	ns
Chip Disable (\overline{CE}_2) to Output in High Z	t_{HZ2}	0	70	0	80	ns
Output Hold from Address Change	t_{OH}	15	—	15	—	ns

● TIMING WAVEFORM OF READ CYCLE (Notes 1)

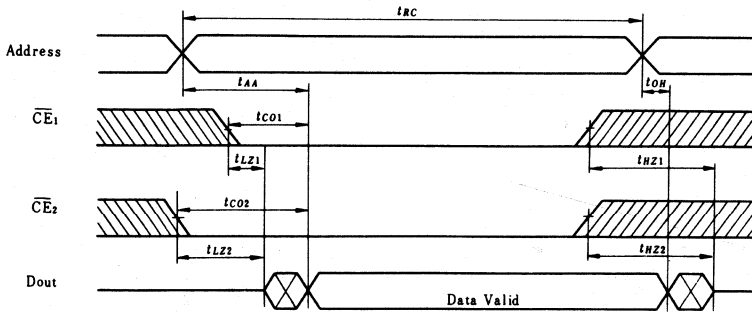

NOTES: 1. \overline{WE} is High for Read Cycle.

● WRITE CYCLE

Item	Symbol	HM6117P-3		HM6117P-4		Unit
		min	max	min	max	
Write Cycle Time	t_{wc}	150	—	200	—	ns
Chip Enable (\overline{CE}_1) to End of Write	t_{cw1}	100	—	120	—	ns
Chip Enable (\overline{CE}_2) to End of Write	t_{cw2}	110	—	130	—	ns
Address Set Up Time	t_{as}	20	—	20	—	ns
Address Valid to End of Write	t_{aw}	130	—	150	—	ns
Write Pulse Width	t_{wp}	100	—	120	—	ns
Write Recovery Time	t_{wr}	15	—	15	—	ns
Write to Output in High Z	t_{whz}	0	60	0	70	ns
Data to Write Time Overlap	t_{dw}	50	—	60	—	ns
Data Hold from Write Time	t_{dh}	20	—	20	—	ns
Output Active from End of Write	t_{ow}	10	—	10	—	ns

● TIMING WAVEFORM OF WRITE CYCLE

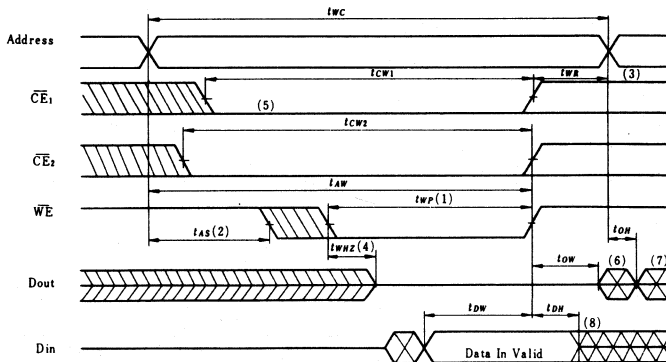

- NOTES: 1. A write occurs during the overlap (t_{WP}) of low \overline{CE}_1 , \overline{CE}_2 and \overline{WE} .
2. t_{AS} is measured from the address changes to the beginning of the write.
3. t_{WR} is measured from the earlier of \overline{CE}_1 , \overline{CE}_2 or \overline{WE} going high to the end/of write cycle.
4. During this period, I/O pins are in the output state so that the input signals of opposite phase to the outputs must not be applied.
5. If the \overline{CE}_1 or \overline{CE}_2 low transition occurs simultaneously with the \overline{WE} low transitions or after the \overline{WE} low transitions, output remain in a high impedance state.
6. Dout is the same phase of write data of this write cycle.
7. Dout is the read data of next address.
8. If \overline{CE}_1 and \overline{CE}_2 are low during this period, I/O pins are in the output state. Then the data input signals of opposite phase to the outputs must not be applied to them.

**SUPPLY CURRENT
vs. SUPPLY VOLTAGE**

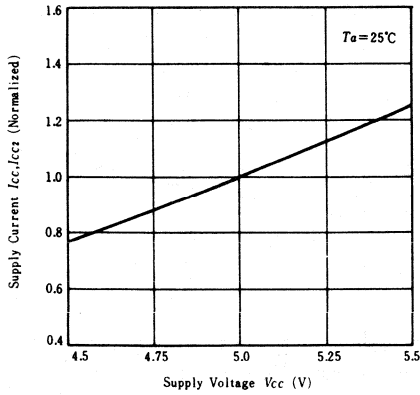

**SUPPLY CURRENT
vs. AMBIENT TEMPERATURE**

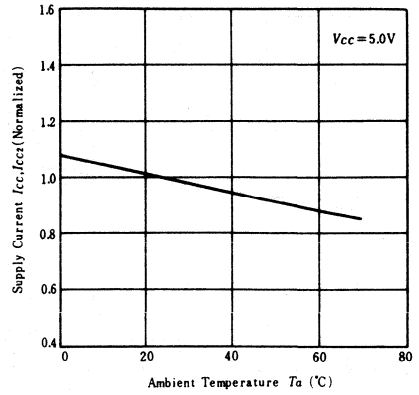

**ACCESS TIME
vs. SUPPLY VOLTAGE**

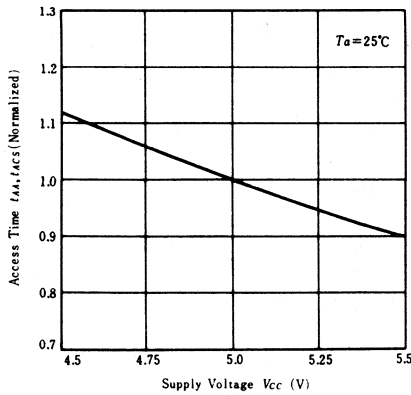

**ACCESS TIME
vs. AMBIENT TEMPERATURE**

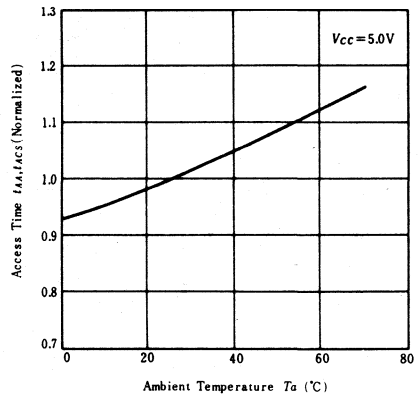

**ACCESS TIME
vs. LOAD CAPACITANCE**

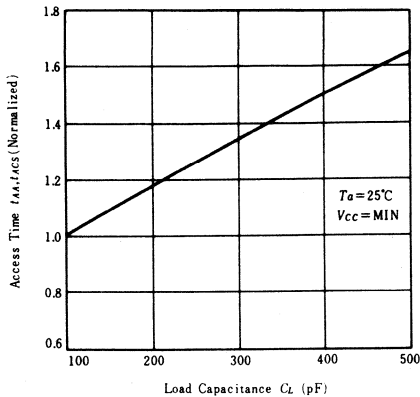

**SUPPLY CURRENT
vs. FREQUENCY**

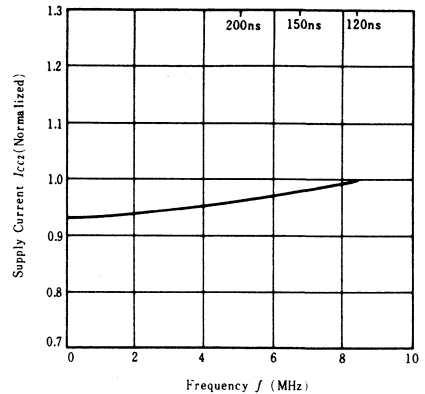

**INPUT LOW VOLTAGE
vs. SUPPLY VOLTAGE**

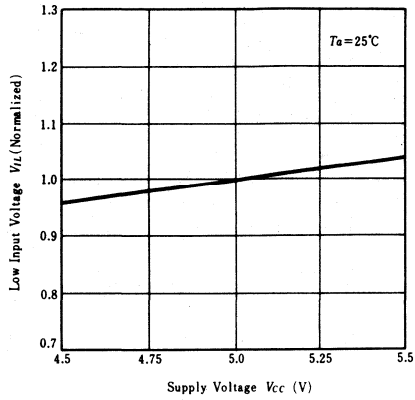

**INPUT HIGH VOLTAGE
vs. SUPPLY VOLTAGE**

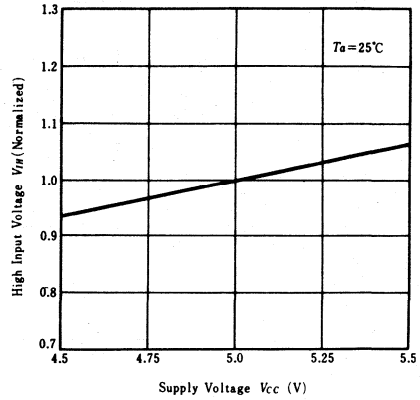

**OUTPUT HIGH CURRENT
vs. OUTPUT HIGH VOLTAGE**

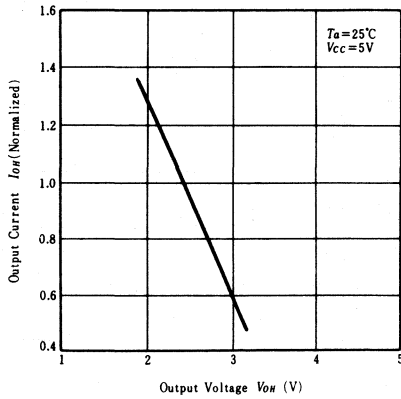

**OUTPUT LOW CURRENT
vs. OUTPUT LOW VOLTAGE**

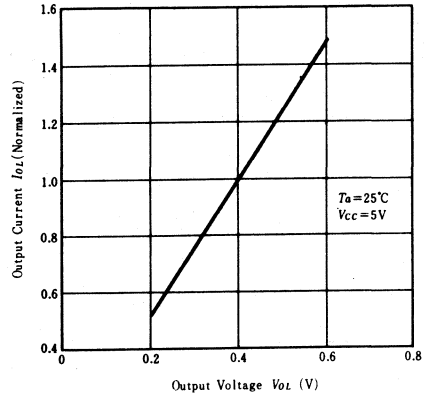

HM6117FP-3, HM6117FP-4

2048-word × 8-bit High Speed Static CMOS RAM

FEATURES

- High Density Small Sized Package
- Projection Area Reduced to One-Thirds of Conventional DIP
- Thickness Reduced to a Half of Conventional DIP
- Single 5V Supply and High Density 24 pin Package.
- High Speed: Fast Access Time 150ns/200ns (max.)
- Low Power Standby and Standby: 100μW (typ.)
- Low Power Operation: Operation: 200mW (typ.)
- Completely Static RAM: No clock nor Timing Strobe Required
- Directly TTL Compatible: All Input and Output
- Equal Access and Cycle Time

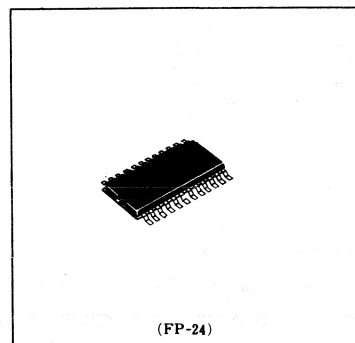

FUNCTIONAL BLOCK DIAGRAM

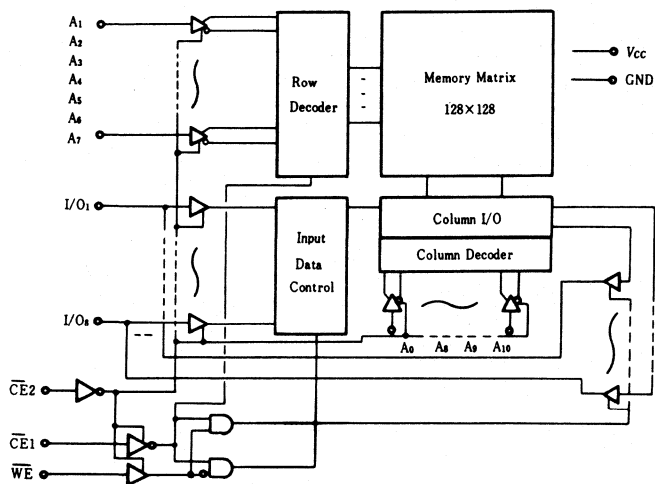

PIN ARRANGEMENT

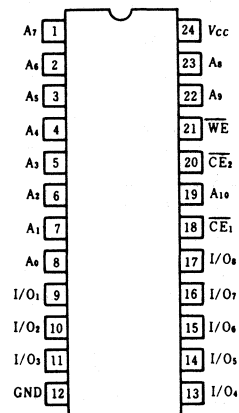

(Top View)

ABSOLUTE MAXIMUM RATINGS

Item	Symbol	Rating	Unit
Voltage on Any Pin Relative to GND	V_T	*-0.5 to +7.0	V
Power Dissipation	P_T	1.0	W
Operating Temperature	T_{opr}	0 to +70	°C
Storage Temperature	T_{stg}	-55 to +125	°C
Temperature Under Bias	T_{bias}	-10 to +85	°C

* Pulse width 50ns: -1.5V

TRUTH TABLE

\overline{CE}_1	\overline{CE}_2	WE	Mode	V_{CC} Current	I/O Pin
H	X	X	Not Selected	I_{CCL1}	High Z
X	H	X	Not Selected	I_{CCL2}	High Z
L	L	H	Read	I_{CC}	Dout
L	L	L	Write	I_{CC}	Din

RECOMMENDED DC OPERATING CONDITIONS ($0^{\circ}\text{C} \leq T_a \leq 70^{\circ}\text{C}$)

Item	Symbol	min	typ	max	Unit
Supply Voltage	V_{CC}	4.5	5.0	5.5	V
	GND	0	0	0	V
Input High (logic 1) Voltage	V_{IH}	2.2	3.5	6.0	V
Input low (logic 0) Voltage	V_{IL}	-1.0*	—	0.8	V

* Pulse width : 50ns, DC : $V_{ILmax} = -0.3\text{V}$

DC AND OPERATING CHARACTERISTICS ($T_a = 0^{\circ}\text{C}$ to $+70^{\circ}\text{C}$, $V_{CC} = 5\text{V} \pm 10\%$, $\text{GND} = 0\text{V}$)

Item	Symbol	Test Conditions	min	typ	max	Unit
Input Leakage Current	$ I_{LI} $	$V_{iN} = \text{GND to } V_{CC}$	—	—	10	μA
Output Leakage Current	$ I_{LO} $	$\overline{\text{CE}}_1 = V_{IH}$ or $\overline{\text{CE}}_2 = V_{IH}$ $V_{iO} = \text{GND to } V_{CC}$	—	—	10	μA
Operating Power Supply Current : DC	I_{CC}	$\overline{\text{CE}}_1 = \overline{\text{CE}}_2 = V_{IL}$, $I_{iO} = 0\text{mA}$	—	40	80	mA
Average Operating Current	I_{CC1}	Min cycle, duty=100% $\overline{\text{CE}}_1 = V_{IL}$, $\overline{\text{CE}}_2 = V_{IL}$	—	40	80	mA
Standby Power Supply Current (1) : DC	I_{CC1}^*	$\overline{\text{CE}}_1 \geq V_{CC} - 0.2\text{V}$, $V_{iN} \geq V_{CC} - 0.2\text{V}$ or $V_{iN} \leq 0.2\text{V}$	—	0.02	2	mA
Standby Power Supply Current (2) : DC	I_{CC2}^*	$\overline{\text{CE}}_2 \geq V_{CC} - 0.2\text{V}$	—	0.02	2	mA
Output low Voltage	V_{OL}	$I_{OL} = 2.1\text{mA}$	—	—	0.4	V
Output High Voltage	V_{OH}	$I_{OH} = -1.0\text{mA}$	2.4	—	—	V

Notes : 1) Typical limits are at $V_{CC} = 5.0\text{V}$, $T_a = +25^{\circ}\text{C}$

2) * : $V_{ILmax} = -0.3\text{V}$

CAPACITANCE ($T_a = 25^{\circ}\text{C}$, $f = 1.0\text{MHz}$)

Item	Symbol	Test Conditions	typ	max	Unit
Input Capacitance	C_{IN}	$V_{iN} = 0\text{V}$	3	5	pF
Input/Output Capacitance	C_{iO}	$V_{iO} = 0\text{V}$	5	7	pF

Note) This parameter is sampled and not 100% tested.

AC CHARACTERISTICS ($T_a = 0^{\circ}\text{C}$ to $+70^{\circ}\text{C}$, $V_{CC} = 5\text{V} \pm 10\%$ unless otherwise noted)

AC TEST CONDITIONS

Input Pulse Levels: 0.8 to 2.4V

Input Rise and Fall Times: 10 ns

Input and Output Timing Reference Levels: 1.5V

Output Load: 1TTL Gate and $C_L = 100\text{pF}$ (including scope and jig)

READ CYCLE

Item	Symbol	HM6117P-3		HM6117P-4		Unit
		min	max	min	max	
Read Cycle Time	t_{RC}	150	—	200	—	ns
Address Access Time	t_{AA}	—	150	—	200	ns
Chip Enable ($\overline{\text{CE}}_1$) to Output	t_{CO1}	—	150	—	200	ns
Chip Enable ($\overline{\text{CE}}_2$) to Output	t_{CO2}	—	150	—	200	ns
Chip Enable ($\overline{\text{CE}}_1$) to Output in Low Z	t_{LZ1}	10	—	10	—	ns
Chip Enable ($\overline{\text{CE}}_2$) to Output in Low Z	t_{LZ2}	10	—	10	—	ns
Chip Disable ($\overline{\text{CE}}_1$) to Output in High Z	t_{HZ1}	0	70	0	80	ns
Chip Disable ($\overline{\text{CE}}_2$) to Output in High Z	t_{HZ2}	0	70	0	80	ns
Output Hold from Address Change	t_{OH}	15	—	15	—	ns

● TIMING WAVEFORM OF READ CYCLE (Notes 1)

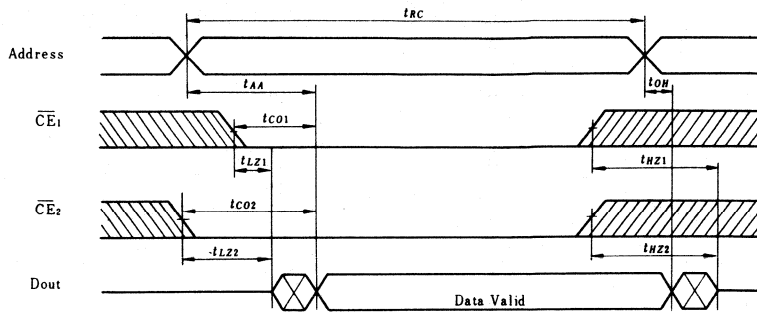

NOTES: 1. \overline{WE} is High for Read Cycle.

● WRITE CYCLE

Item	Symbol	HM6117P-3		HM6117P-4		Unit
		min	max	min	max	
Write Cycle Time	t_{WC}	150	—	200	—	ns
Chip Enable (\overline{CE}_1) to End of Write	t_{CW1}	100	—	120	—	ns
Chip Enable (\overline{CE}_2) to End of Write	t_{CW2}	110	—	130	—	ns
Address Set Up Time	t_{AS}	20	—	20	—	ns
Address Valid to End of Write	t_{AW}	130	—	150	—	ns
Write Pulse Width	t_{WP}	100	—	120	—	ns
Write Recovery Time	t_{WR}	15	—	15	—	ns
Write to Output in High Z	t_{WHZ}	0	60	0	70	ns
Data to Write Time Overlap	t_{DW}	50	—	60	—	ns
Data Hold from Write Time	t_{DH}	20	—	20	—	ns
Output Active from End of Write	t_{OW}	10	—	10	—	ns

● TIMING WAVEFORM OF WRITE CYCLE

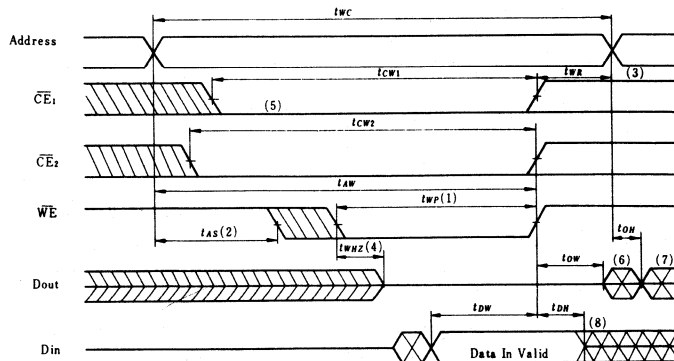

- NOTES: 1. A write occurs during the overlap (t_{WP}) of low \overline{CE}_1 , \overline{CE}_2 and \overline{WE} .
2. t_{AS} is measured from the address changes to the beginning of the write.
3. t_{WR} is measured from the earlier of \overline{CE}_1 , \overline{CE}_2 or \overline{WE} going high to the end/of write cycle.

4. During this period, I/O pins are in the output state so that the input signals of opposite phase to the outputs must not be applied.
5. If the \overline{CE}_1 or \overline{CE}_2 low transition occurs simultaneously with the \overline{WE} low transitions or after the \overline{WE} transitions, output remain in a high impedance state.

6. D_{out} is the same phase of write data of this write cycle.
7. D_{out} is the read data of next address.
8. If \overline{CE}_1 and \overline{CE}_2 are low during this period, I/O pins are in the output state. Then the data input signals of opposite phase to the outputs must not be applied to them.

**SUPPLY CURRENT
vs. SUPPLY VOLTAGE**

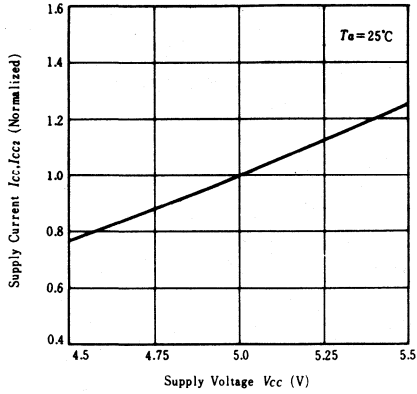

**SUPPLY CURRENT
vs. AMBIENT TEMPERATURE**

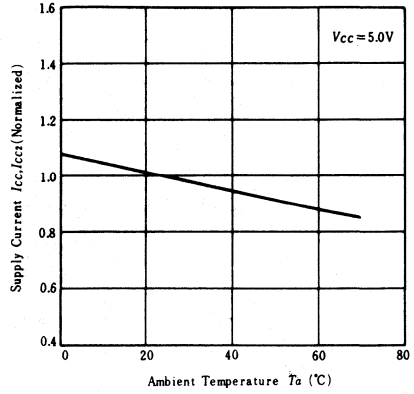

**ACCESS TIME
vs. SUPPLY VOLTAGE**

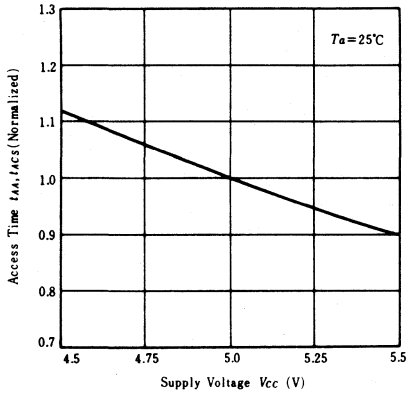

**ACCESS TIME
vs. AMBIENT TEMPERATURE**

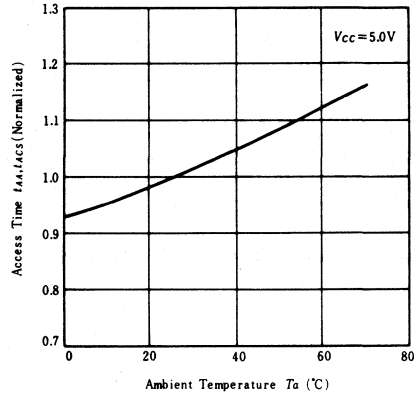

**ACCESS TIME
vs. LOAD CAPACITANCE**

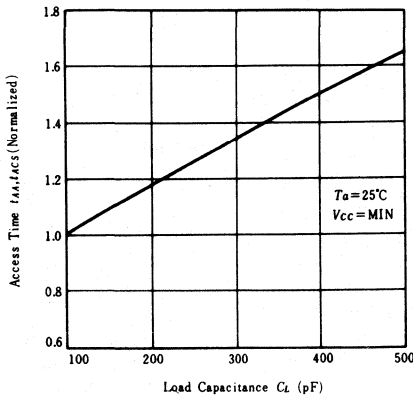

**SUPPLY CURRENT
vs. FREQUENCY**

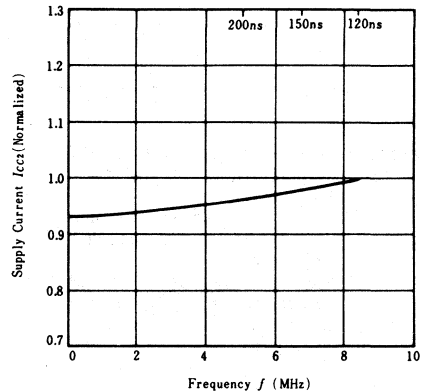

**INPUT LOW VOLTAGE
vs. SUPPLY VOLTAGE**

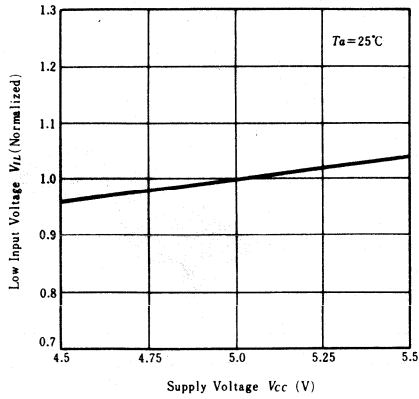

**INPUT HIGH VOLTAGE
vs. SUPPLY VOLTAGE**

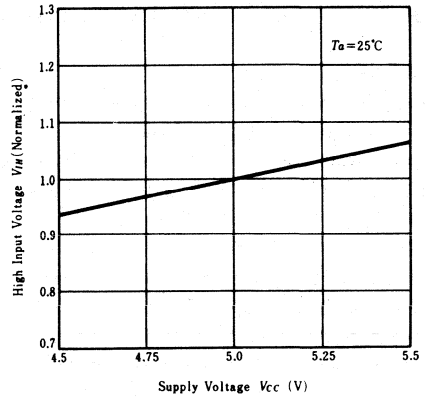

**OUTPUT HIGH CURRENT
vs. OUTPUT HIGH VOLTAGE**

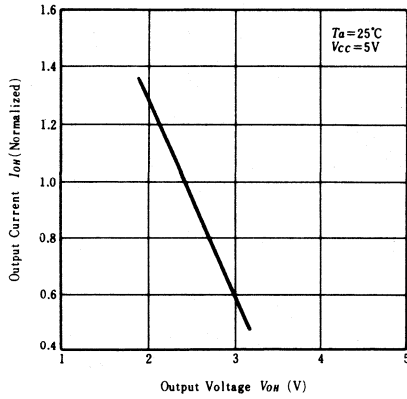

**OUTPUT LOW CURRENT
vs. OUTPUT LOW VOLTAGE**

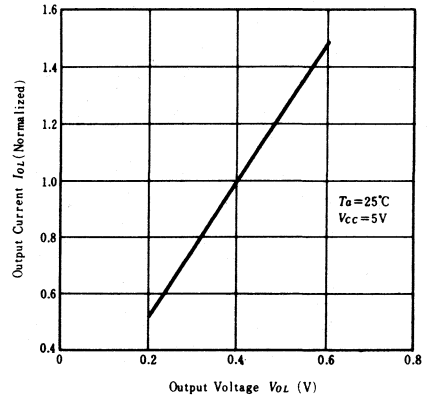

HM6117LP-3, HM6117LP-4

2048-word × 8-bit High Speed Static CMOS RAM

FEATURES

- Single 5V Supply and High Density 24 Pin Package.
- High Speed: Fast Access Time 150ns/200ns max.
- Low Power Standby and Low Power Operation;
Standby: 10μW (typ.) Two Chip Enable Input for Battery Back up Operation: 180mW (typ.)
- Completely Static RAM: No clock nor Timing Strobe Required
- Directly TTL Compatible: All Input and Output
- Equal Access and Cycle Time
- Capability of Battery Back up Operation

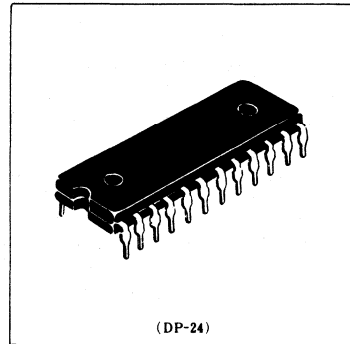

FUNCTIONAL BLOCK DIAGRAM

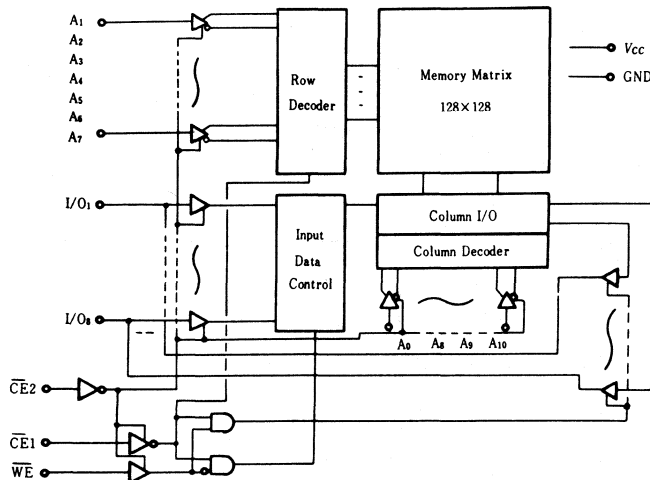

PIN ARRANGEMENT

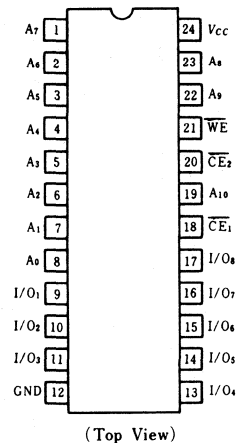

ABSOLUTE MAXIMUM RATINGS

Item	Symbol	Rating	Unit
Voltage on Any Pin Relative to GND	V_T	*-0.5 to +7.0	V
Operating Temperature	T_{opr}	0 to +70	°C
Storage Temperature	T_{stg}	-55 to +125	°C
Temperature Under Bias	T_{bias}	-10 to +85	°C
Power Dissipation	P_T	1.0	W

* Pulse width 50ns : -1.5V

TRUTH TABLE

\overline{CE}_1	\overline{CE}_2	WE	Mode	V_{cc} Current	I/O Pin
H	×	×	Not Selected	I_{ccl1}	High Z
×	H	×	Not Selected	I_{ccl2}	High Z
L	L	H	Read	I_{cc}	Dout
L	L	L	Write	I_{cc}	Din

■ RECOMMENDED DC OPERATING CONDITIONS ($T_a=0^{\circ}\text{C}$ to $+70^{\circ}\text{C}$)

Item	Symbol	min	typ	max	Unit
Supply Voltage	V_{CC}	4.5	5.0	5.5	V
	GND	0	0	0	V
Input High (logic 1) Voltage	V_{IH}	2.2	3.5	6.0	V
Input low (logic 0) Voltage	V_{IL}	-1.0*	—	0.8	V

* Pulse Width: 50ns, DC: $V_{ILmin} = -0.3\text{V}$.

■ DC AND OPERATING CHARACTERISTICS ($T_a=0^{\circ}\text{C}$ to $+70^{\circ}\text{C}$, $V_{CC}=5\text{V}\pm 10\%$, GND=0V)

Item	Symbol	Test Conditions	min	typ	max	Unit
Input Leakage Current	$ I_{LI} $	$V_{IN}=\text{GND to } V_{CC}$	—	—	2	μA
Output Leakage Current	$ I_{LO} $	$\overline{\text{CE}}_1=V_{IH}$ or $\overline{\text{CE}}_2=V_{IH}$ $V_{I/O}=\text{GND to } V_{CC}$	—	—	2	μA
Operating Power Supply Current : DC	I_{CC}	$\overline{\text{CE}}_1=\overline{\text{CE}}_2=V_{IL}$, $I_{I/O}=0\text{mA}$	—	35	70	mA
Average Operating Current	I_{CC1}	Min cycle, duty=100% $\overline{\text{CE}}_1=V_{IL}$, $\overline{\text{CE}}_2=V_{IL}$	—	35	70	mA
Standby Power Supply Current (1) : DC	I_{CC1}^*	$\overline{\text{CE}}_1 \geq V_{CC}-0.2\text{V}$ $V_{IN} \geq V_{CC}-0.2\text{V}$ or $V_{IN} \leq 0.2\text{V}$	—	2	50	μA
Standby Power Supply Current (2) : DC	I_{CC2}^*	$\overline{\text{CE}}_2 \geq V_{CC}-0.2\text{V}$	—	2	50	μA
Output low Voltage	V_{OL}	$I_{OL}=2.1\text{mA}$	—	—	0.4	V
Output High Voltage	V_{OH}	$I_{OH}=-1.0\text{mA}$	2.4	—	—	V

Notes: 1) Typical limits are at $V_{CC}=5.0\text{V}$, $T_a=+25^{\circ}\text{C}$

2) * : $V_{ILmin} = -0.3\text{V}$

■ CAPACITANCE ($T_a=25^{\circ}\text{C}$, $f=1.0\text{MHz}$)

Item	Symbol	Test Conditions	typ	max	Unit
Input Capacitance	C_{IN}	$V_{IN}=0\text{V}$	3	5	pF
Input/Output Capacitance	$C_{I/O}$	$V_{I/O}=0\text{V}$	5	7	pF

Note :1) This parameter is sampled and not 100% tested.

■ AC CHARACTERISTICS ($T_a=0^{\circ}\text{C}$ to $+70^{\circ}\text{C}$, $V_{CC}=5\text{V}\pm 10\%$ unless otherwise noted)

● AC TEST CONDITIONS

Input Pulse Levels 0.8V to 2.4V

Input Rise and Fall Times 10ns

Input and Output Timing Reference Levels . . . 1.5V

Output Load 1 TTL Gate and $C_L = 100\text{pF}$ (Including Scope & Jig)

● READ CYCLE

Item	Symbol	HM6117LP-3		HM6117LP-4		Unit
		min	max	min	max	
Read Cycle Time	t_{RC}	150	—	200	—	ns
Address Access Time	t_{AA}	—	150	—	200	ns
Chip Enable ($\overline{\text{CE}}_1$) to Output	t_{CO1}	—	150	—	200	ns
Chip Enable ($\overline{\text{CE}}_2$) to Output	t_{CO2}	—	150	—	200	ns
Chip Enable ($\overline{\text{CE}}_1$) to Output in Low Z	t_{LZ1}	10	—	10	—	ns
Chip Enable ($\overline{\text{CE}}_2$) to Output in Low Z	t_{LZ2}	10	—	10	—	ns
Chip Disable ($\overline{\text{CE}}_1$) to Output in High Z	t_{HZ1}	0	70	0	80	ns
Chip Disable ($\overline{\text{CE}}_2$) to Output in High Z	t_{HZ2}	0	70	0	80	ns
Output Hold from Address Change	t_{OH}	15	—	15	—	ns

● TIMING WAVEFORM OF READ CYCLE (Notes 1)

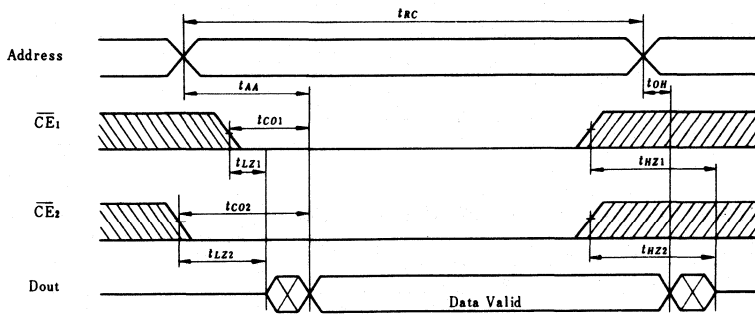

NOTES: 1. \overline{WE} is High for Read Cycle.

● WRITE CYCLE

Item	Symbol	HM6117LP-3		HM6117LP-4		Unit
		min	max	min	max	
Write Cycle Time	t_{WC}	150	—	200	—	ns
Chip Enable (\overline{CE}_1) to End of Write	t_{CW1}	100	—	120	—	ns
Chip Enable (\overline{CE}_2) to End of Write	t_{CW2}	110	—	130	—	ns
Address Set Up Time	t_{AS}	20	—	20	—	ns
Address Valid to End of Write	t_{AW}	130	—	150	—	ns
Write Pulse Width	t_{WP}	100	—	120	—	ns
Write Recovery Time	t_{WR}	15	—	15	—	ns
Write to Output in High Z	t_{WHZ}	0	60	0	70	ns
Data to Write Time Overlap	t_{DW}	50	—	60	—	ns
Data Hold from Write Time	t_{DH}	20	—	20	—	ns
Output Active from End of Write	t_{OW}	10	—	10	—	ns

● TIMING WAVEFORM OF WRITE CYCLE

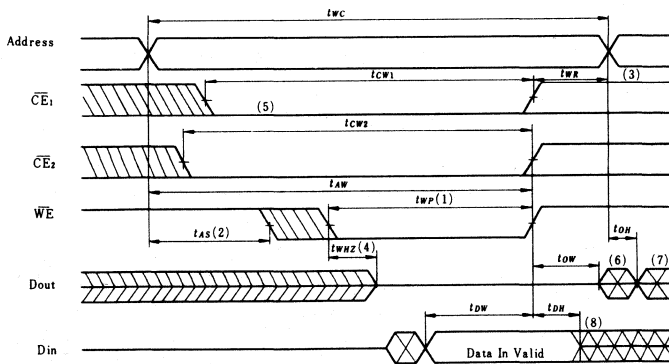

- NOTES: 1. A write occurs during the overlap (t_{WP}) of low \overline{CE}_1 , \overline{CE}_2 and \overline{WE} .
2. t_{AS} is measured from the address changes to the beginning of the write.
3. t_{WR} is measured from the earlier of \overline{CE}_1 , \overline{CE}_2 or \overline{WE} going high to the end/of write cycle.
4. During this period, I/O pins are in the output state so that the input signals of opposite phase to the outputs must not be applied.
5. If the \overline{CE}_1 or \overline{CE}_2 low transition occurs simultaneously with the \overline{WE} low transitions or after the \overline{WE} transitions, output remain in a high impedance state.
6. Dout is the same phase of write data of this write cycle.
7. Dout is the read data of next address.
8. If \overline{CE}_1 and \overline{CE}_2 are low during this period, I/O pins are in the output state. Then the data input signals of opposite phase to the outputs must not be applied to them.

LOW V_{CC} DATA RETENTION CHARACTERISTICS ($T_a=0^{\circ}\text{C}$ to $+70^{\circ}\text{C}$)

Item	Symbol	Test Conditions	min	typ	max	Unit
V_{CC} for Data Retention	V_{DR1}	$\overline{CE}_1 \geq V_{CC} - 0.2\text{V}$, $V_{IN} \geq V_{CC} - 0.2\text{V}$ or $V_{IN} \leq 0.2\text{V}$	2.0	—	—	V
V_{CC} for Data Retention	V_{DR2}	$\overline{CE}_2 \geq V_{CC} - 0.2\text{V}$	2.0	—	—	V
Data Retention Current	I_{CCDR1}	$V_{CC} = 3.0\text{V}$, $\overline{CE}_1 \geq 2.8\text{V}$, $V_{IN} \geq 2.8\text{V}$ or $V_{IN} \leq 0.2\text{V}$	—	—	30*	μA
Data Retention Current	I_{CCDR2}	$V_{CC} = 3.0\text{V}$, $\overline{CE}_2 \geq V_{CC} - 0.2\text{V}$	—	—	30*	μA
Chip Deselect to Data Retention Time	t_{CDR}	See Retention Waveform	0	—	—	ns
Operation Recovery Time	t_R		t_{RC}^{**}	—	—	—

* 10 μA max at $T_a=0^{\circ}\text{C}$ to $+40^{\circ}\text{C}$, V_{IL} min = -0.3V
 ** t_{RC} - Read Cycle Time

LOW V_{CC} DATA RETENTION WAVEFORM

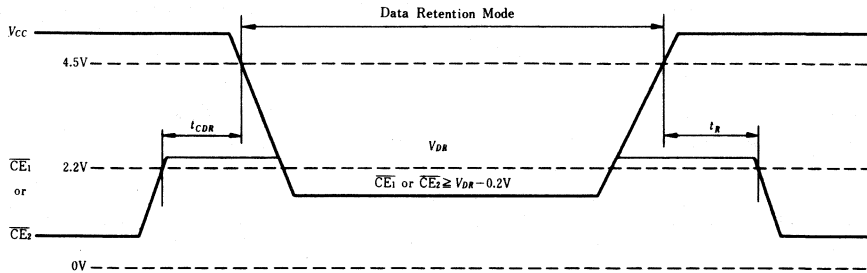

NOTE: 1. \overline{CE}_2 controls Address buffer, \overline{WE} buffer, \overline{CE}_1 buffer and D_{IN} buffer. If \overline{CE}_2 controls data retention mode, V_{IN} level (address, \overline{WE} , \overline{CE}_1 , $D_{I/O}$) can be in the high impedance state. If \overline{CE}_1 controls data retention mode, V_{IN} level (address, \overline{WE} , \overline{DE}_2 , $D_{I/O}$) must be $V_{IN} \geq V_{CC} - 0.2\text{V}$ or $V_{IN} \leq 0.2\text{V}$.

SUPPLY CURRENT vs. SUPPLY VOLTAGE

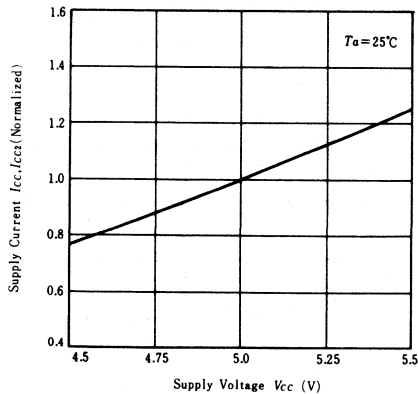

SUPPLY CURRENT vs. AMBIENT TEMPERATURE

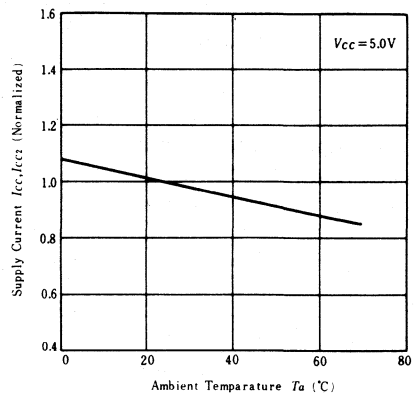

ACCESS TIME vs. SUPPLY VOLTAGE

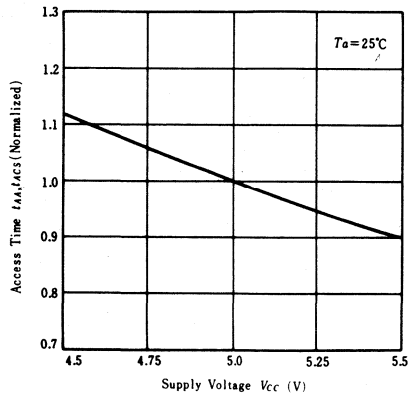

ACCESS TIME vs. AMBIENT TEMPERATURE

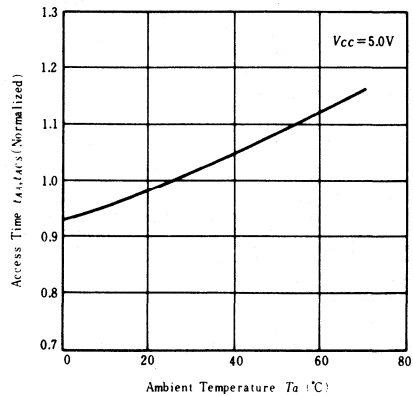

ACCESS TIME vs. LOAD CAPACITANCE

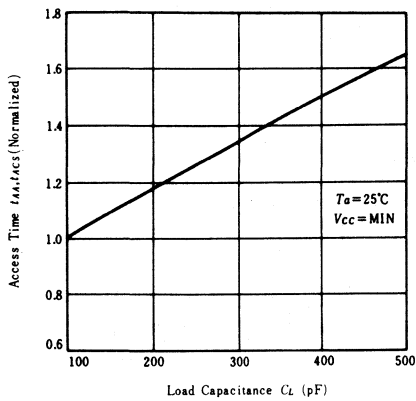

SUPPLY CURRENT vs. FREQUENCY

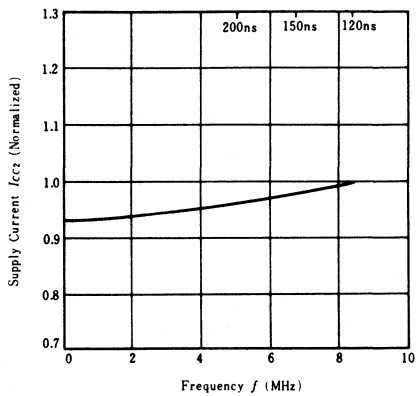

INPUT LOW VOLTAGE vs. SUPPLY VOLTAGE

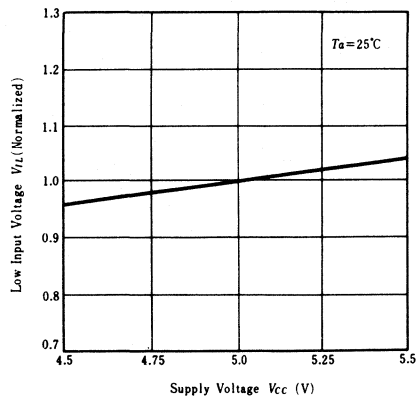

INPUT HIGH VOLTAGE vs. SUPPLY VOLTAGE

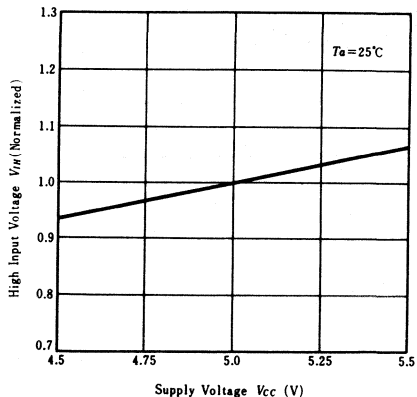

OUTPUT HIGH CURRENT vs. OUTPUT HIGH VOLTAGE

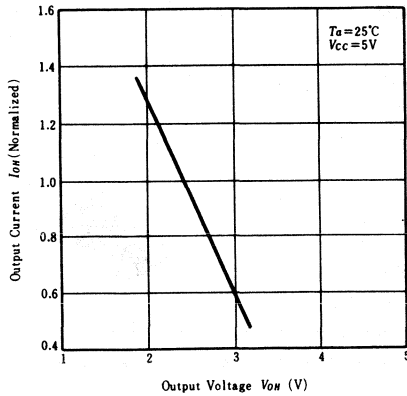

OUTPUT LOW CURRENT vs. OUTPUT LOW VOLTAGE

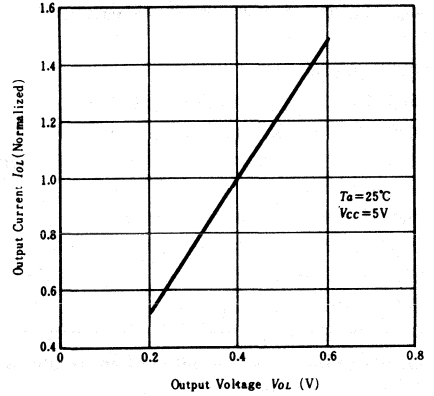

STAND-BY CURRENT vs. AMBIENT TEMPERATURE

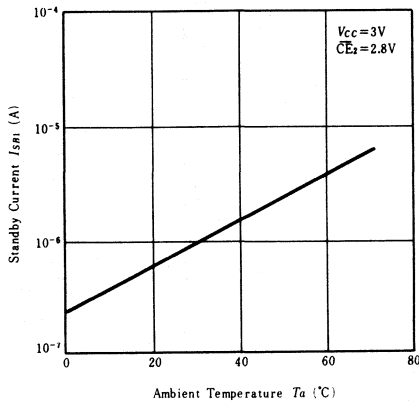

STAND-BY CURRENT vs. SUPPLY VOLTAGE

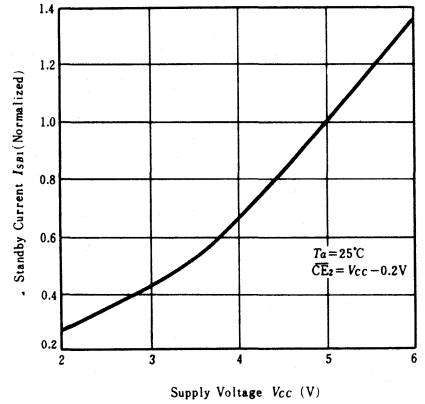

STAND-BY CURRENT vs. INPUT VOLTAGE

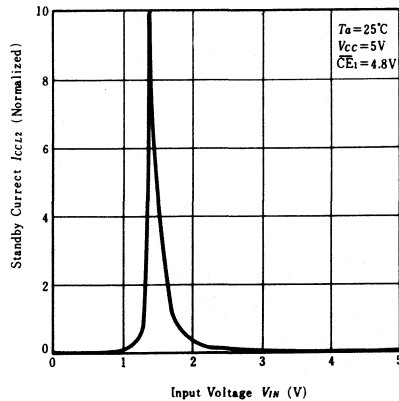

STAND-BY CURRENT vs. INPUT VOLTAGE

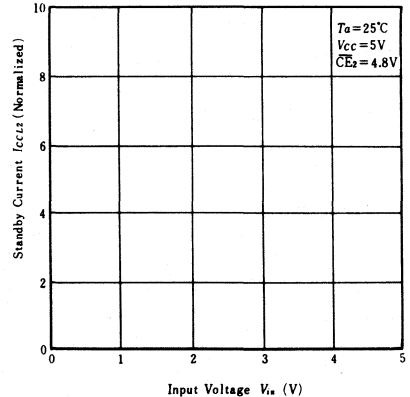

HM6117LFP-3, HM6117LFP-4

2048-word × 8-bit High Speed Static CMOS RAM

FEATURES

- High Density Small-sized Packaged
- Projection Area Reduced to One-Thirds of Conventional DIP
- Thickness Reduced to a Half of Conventional DIP
- Single 5V Supply
- High Speed: Fast Access Time 150ns/200ns max.
- Low Power Standby and Low Power Operation;
Standby: 10μW (typ.) Two Chip Enable Input for Battery Back up
Operation: 180mW (typ.)
- Completely Static RAM: No clock nor Timing Strobe Required
- Directly TTL Compatible: All Input and Output
- Equal Access and Cycle Time
- Capability of Battery Back up Operation

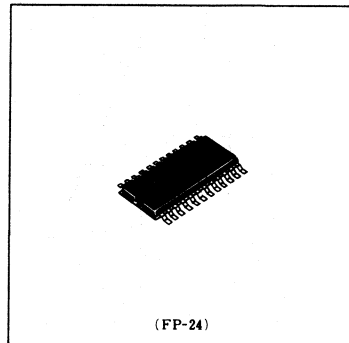

FUNCTIONAL BLOCK DIAGRAM

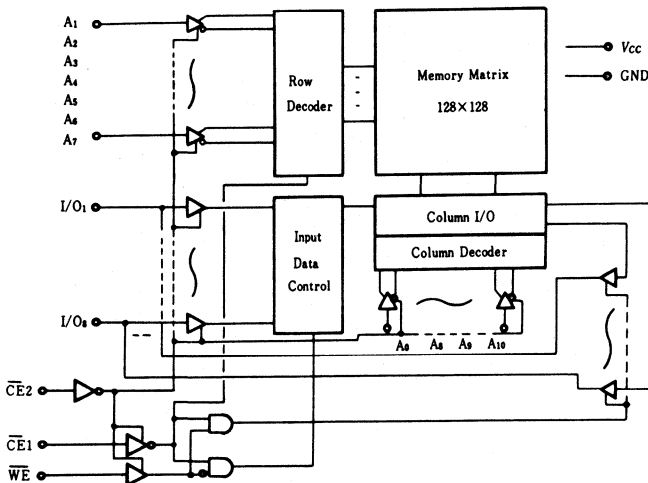

PIN ARRANGEMENT

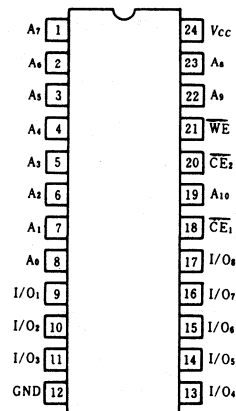

(Top View)

ABSOLUTE MAXIMUM RATINGS

Item	Symbol	Rating	Unit
Voltage on Any Pin Relative to GND	V_T	*-0.5 to +7.0	V
Operating Temperature	T_{opr}	0 to +70	°C
Storage Temperature	T_{stg}	-55 to +125	°C
Temperature Under Bias	T_{bia}	-10 to +85	°C
Power Dissipation	P_T	1.0	W

* Pulse width 50ns : -1.5V

TRUTH TABLE

\overline{CE}_1	\overline{CE}_2	\overline{WE}	Mode	V_{CC} Current	I/O Pin
H	×	×	Not Selected	I_{CC1}	High Z
×	H	×	Not Selected	I_{CC2}	High Z
L	L	H	Read	I_{CC}	Dout
L	L	L	Write	I_{CC}	Din

■ RECOMMENDED DC OPERATING CONDITIONS ($T_a=0^{\circ}\text{C}$ to $+70^{\circ}\text{C}$)

Item	Symbol	min	typ	max	Unit
Supply Voltage	V_{CC}	4.5	5.0	5.5	V
	GND	0	0	0	V
Input High (logic 1) Voltage	V_{IH}	2.2	3.5	6.0	V
Input low (logic 0) Voltage	V_{IL}	-1.0*	—	0.8	V

* Pulse Width: 50ns, DC: $V_{ILmin} = -0.3\text{V}$.

■ DC AND OPERATING CHARACTERISTICS ($T_a=0^{\circ}\text{C}$ to $+70^{\circ}\text{C}$, $V_{CC}=5\text{V}\pm 10\%$, GND=0V)

Item	Symbol	Test Conditions	min	typ	max	Unit
Input Leakage Current	$ I_{LI} $	$V_{IN} = \text{GND to } V_{CC}$	—	—	2	μA
Output Leakage Current	$ I_{LO} $	$\overline{\text{CE}}_1 = V_{IN}$ or $\overline{\text{CE}}_2 = V_{IN}$ $V_{I/O} = \text{GND to } V_{CC}$	—	—	2	μA
Operating Power Supply Current : DC	I_{CC}	$\overline{\text{CE}}_1 = \overline{\text{CE}}_2 = V_{IL}$, $I_{I/O} = 0\text{mA}$	—	35	70	mA
Average Operating Current	I_{CC1}	Min cycle, duty=100% $\overline{\text{CE}}_1 = V_{IL}$, $\overline{\text{CE}}_2 = V_{IL}$	—	35	70	mA
Standby Power Supply Current (1) : DC	I_{CC1}^*	$\overline{\text{CE}}_1 \geq V_{CC} - 0.2\text{V}$ $V_{IN} \geq V_{CC} - 0.2\text{V}$ or $V_{IN} \leq 0.2\text{V}$	—	2	50	μA
Standby Power Supply Current (2) : DC	I_{CC2}^*	$\overline{\text{CE}}_2 \geq V_{CC} - 0.2\text{V}$	—	2	50	μA
Output low Voltage	V_{OL}	$I_{OL} = 2.1\text{mA}$	—	—	0.4	V
Output High Voltage	V_{OH}	$I_{OH} = -1.0\text{mA}$	2.4	—	—	V

Notes: 1) Typical limits are at $V_{CC}=5.0\text{V}$, $T_a=+25^{\circ}\text{C}$

2) *: $V_{ILmin} = -0.3\text{V}$

■ CAPACITANCE ($T_a=25^{\circ}\text{C}$, $f=1.0\text{MHz}$)

Item	Symbol	Test Conditions	typ	max	Unit
Input Capacitance	C_{IN}	$V_{IN} = 0\text{V}$	3	5	pF
Input/Output Capacitance	$C_{I/O}$	$V_{I/O} = 0\text{V}$	5	7	pF

Note: 1) This parameter is sampled and not 100% tested.

■ AC CHARACTERISTICS ($T_a=0^{\circ}\text{C}$ to $+70^{\circ}\text{C}$, $V_{CC}=5\text{V}\pm 10\%$ unless otherwise noted)

● AC TEST CONDITIONS

Input Pulse Levels 0.8V to 2.4V
 Input Rise and Fall Times 10ns
 Input and Output Timing Reference Levels ... 1.5V
 Output Load 1 TTL Gate and $C_L = 100\text{pF}$ (Including Scope & Jig)

● READ CYCLE

Item	Symbol	HM6117LFP-3		HM6117LFP-4		Unit
		min	max	min	max	
Read Cycle Time	t_{RC}	150	—	200	—	ns
Address Access Time	t_{AA}	—	150	—	200	ns
Chip Enable ($\overline{\text{CE}}_1$) to Output	t_{CO1}	—	150	—	200	ns
Chip Enable ($\overline{\text{CE}}_2$) to Output	t_{CO2}	—	150	—	200	ns
Chip Enable ($\overline{\text{CE}}_1$) to Output in Low Z	t_{LZ1}	10	—	10	—	ns
Chip Enable ($\overline{\text{CE}}_2$) to Output in Low Z	t_{LZ2}	10	—	10	—	ns
Chip Disable ($\overline{\text{CE}}_1$) to Output in High Z	t_{HZ1}	0	70	0	80	ns
Chip Disable ($\overline{\text{CE}}_2$) to Output in High Z	t_{HZ2}	0	70	0	80	ns
Output Hold from Address Change	t_{OH}	15	—	15	—	ns

●TIMING WAVEFORM OF READ CYCLE (Notes 1)

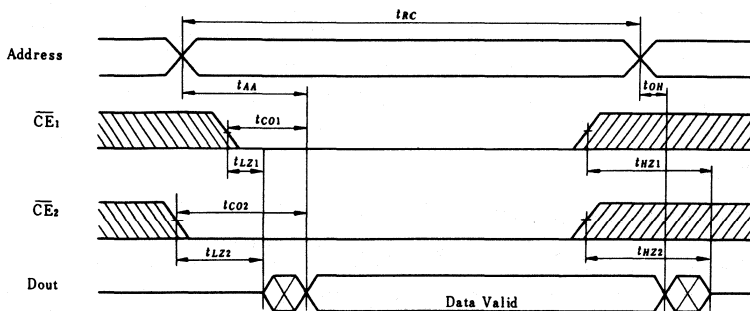

NOTES: 1. \overline{WE} is High for Read Cycle.

●WRITE CYCLE

Item	Symbol	HM6117LFP-3		HM6117LFP-4		Unit
		min	max	min	max	
Write Cycle Time	t_{WC}	150	—	200	—	ns
Chip Enable (\overline{CE}_1) to End of Write	t_{CW1}	100	—	120	—	ns
Chip Enable (\overline{CE}_2) to End of Write	t_{CW2}	110	—	130	—	ns
Address Set Up Time	t_{AS}	20	—	20	—	ns
Address Valid to End of Write	t_{AW}	130	—	150	—	ns
Write Pulse Width	t_{WP}	100	—	120	—	ns
Write Recovery Time	t_{WR}	15	—	15	—	ns
Write to Output in High Z	t_{WNZ}	0	60	0	70	ns
Data to Write Time Overlap	t_{DW}	50	—	60	—	ns
Data Hold from Write Time	t_{DH}	20	—	20	—	ns
Output Active from End of Write	t_{OW}	10	—	10	—	ns

●TIMING WAVEFORM OF WRITE CYCLE

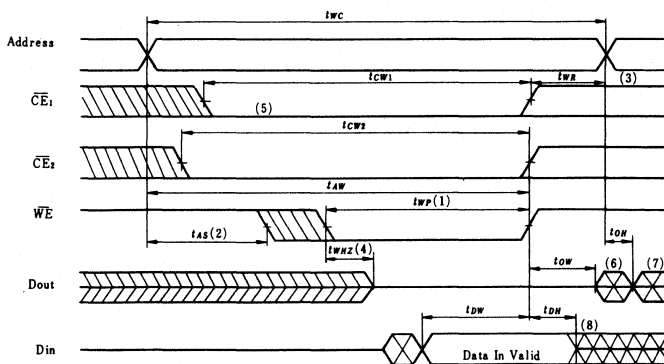

- NOTES: 1 A write occurs during the overlap (t_{WP}) of low \overline{CE}_1 , \overline{CE}_2 and \overline{WE} .
2. t_{AS} is measured from the address changes to the beginning of the write.
3. t_{WR} is measured from the earlier of \overline{CE}_1 , \overline{CE}_2 or \overline{WE} going high to the end/of write cycle.

4. During this period, I/O pins are in the output state so that the input signals of opposite phase to the outputs must not be applied.
5. If the \overline{CE}_1 or \overline{CE}_2 low transition occurs simultaneously with the \overline{WE} low transitions or after the \overline{WE} transitions, output remain in a high impedance state.

6. Dout is the same phase of write data of this write cycle.
7. Dout is the read data of next address.
8. If \overline{CE}_1 and \overline{CE}_2 are low during this period, I/O pins are in the output state. Then the data input signals of opposite phase to the outputs must not be applied to them.

■ **LOW V_{CC} DATA RETENTION CHARACTERISTICS** ($T_a=0^{\circ}\text{C}$ to $+70^{\circ}\text{C}$)

Item	Symbol	Test Condition	min	typ	max	Unit
V_{CC} for Data Retention	V_{DR1}	$\overline{CE}_1 \geq V_{CC}-0.2\text{V}$, $V_{IN} \geq V_{CC}-0.2\text{V}$ or $V_{IN} \leq 0.2\text{V}$	2.0	—	—	V
V_{CC} for Data Retention	V_{DR2}	$\overline{CE}_2 \geq V_{CC}-0.2\text{V}$	2.0	—	—	V
Data Retention Current	I_{CCDR1}	$V_{CC}=3.0\text{V}$, $\overline{CE}_1 \geq 2.8\text{V}$, $V_{IN} \geq 2.8\text{V}$ or $V_{IN} \leq 0.2\text{V}$	—	—	30*	μA
Data Retention Current	I_{CCDR2}	$V_{CC}=3.0\text{V}$, $\overline{CE}_2 \geq V_{CC}-0.2\text{V}$	—	—	30*	μA
Chip Deselect to Data Retention Time	t_{CDR}	See Retention Waveform	0	—	—	ns
Operation Recovery Time	t_R		t_{RC}^{**}	—	—	ns

* $10\mu\text{A}$ max at $T_a=0^{\circ}\text{C}$ to $+40^{\circ}\text{C}$, V_{IL} min = -0.3V
 ** t_{RC} —Read Cycle Time

● **LOW V_{CC} DATA RETENTION WAVEFORM**

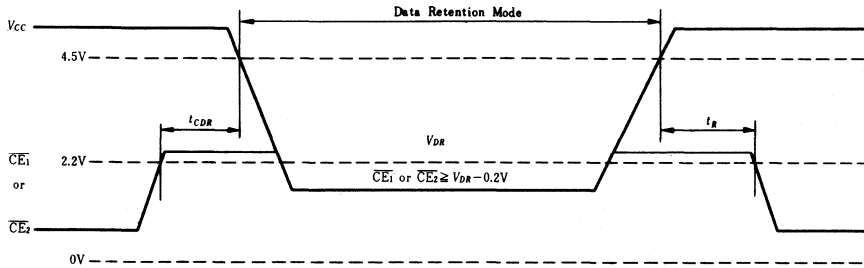

NOTE: 1. \overline{CE}_2 controls Address buffer, \overline{WE} buffer, \overline{CE}_1 buffer and $D_{I/O}$ buffer. If \overline{CE}_2 controls data retention mode, V_{IN} level (address, \overline{WE} , \overline{CE}_1 , $D_{I/O}$) can be in the high impedance state. If \overline{CE}_1 controls data retention mode, V_{IN} level (address, \overline{WE} , \overline{CE}_2 , $D_{I/O}$) must be $V_{IN} \geq V_{CC}-0.2\text{V}$ or $V_{IN} \leq 0.2\text{V}$.

SUPPLY CURRENT vs. SUPPLY VOLTAGE

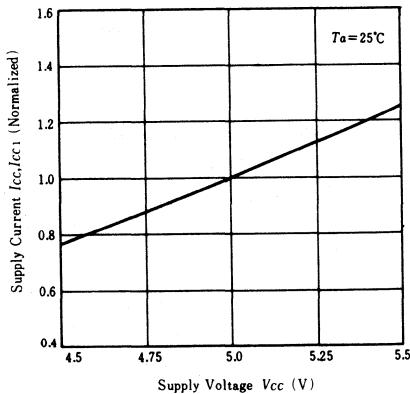

SUPPLY CURRENT vs. AMBIENT TEMPERATURE

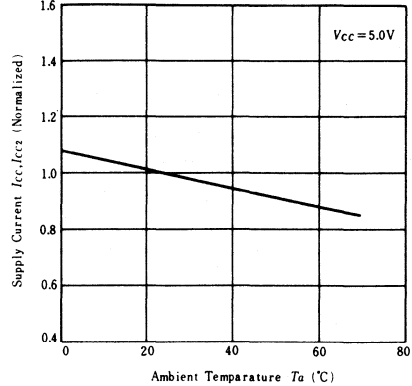

ACCESS TIME vs. SUPPLY VOLTAGE

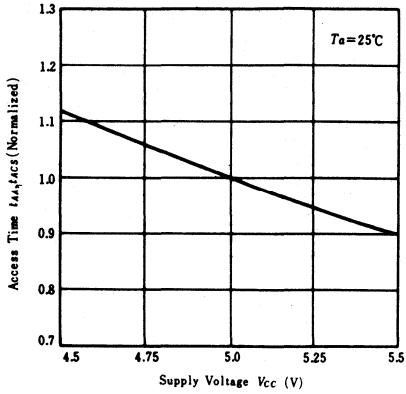

ACCESS TIME vs. AMBIENT TEMPERATURE

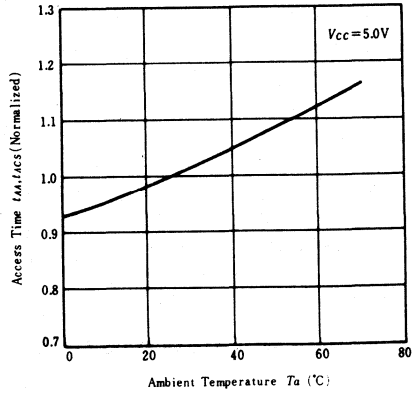

ACCESS TIME vs. LOAD CAPACITANCE

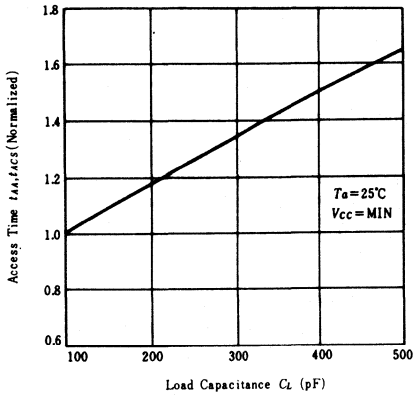

SUPPLY CURRENT vs. FREQUENCY

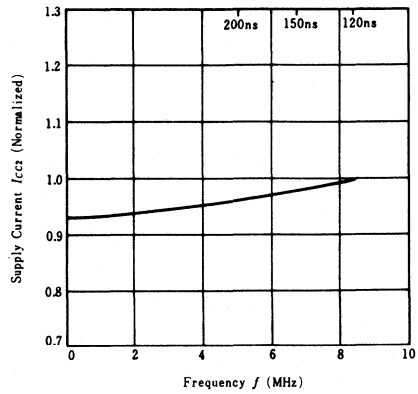

INPUT LOW VOLTAGE vs. SUPPLY VOLTAGE

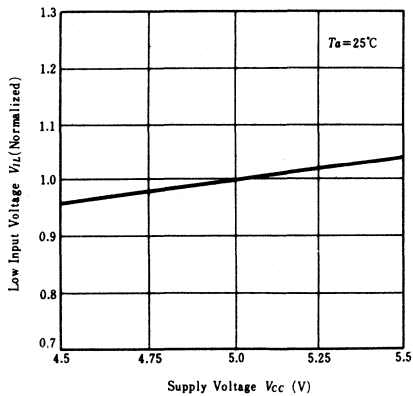

INPUT HIGH VOLTAGE vs. SUPPLY VOLTAGE

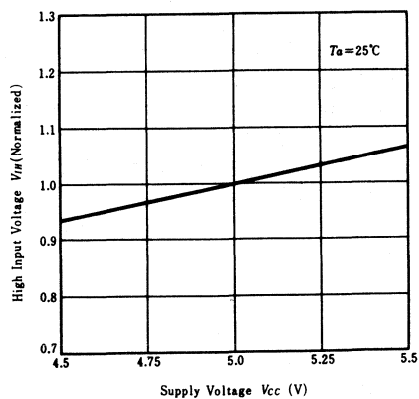

OUTPUT HIGH CURRENT vs. OUTPUT HIGH VOLTAGE

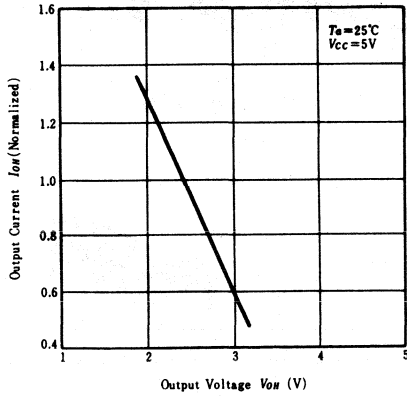

OUTPUT LOW CURRENT vs. OUTPUT LOW VOLTAGE

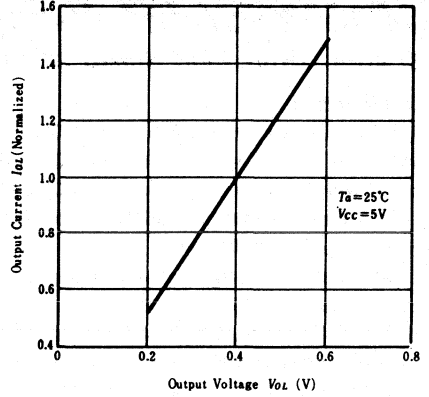

STAND-BY CURRENT vs. AMBIENT TEMPERATURE

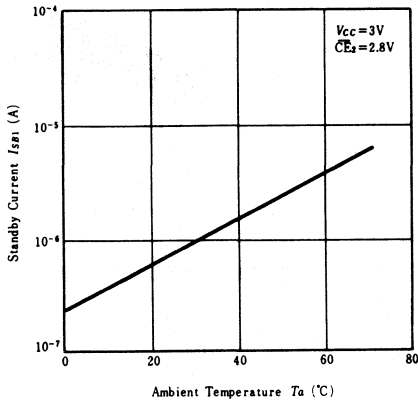

STAND-BY CURRENT vs. SUPPLY VOLTAGE

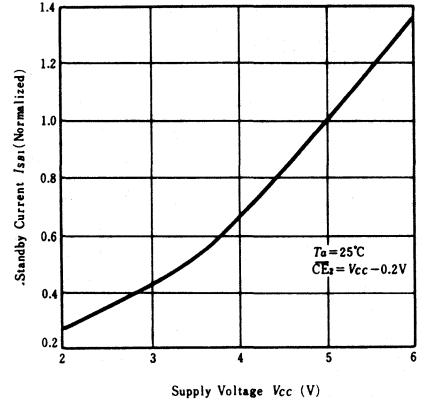

STAND-BY CURRENT vs. INPUT VOLTAGE

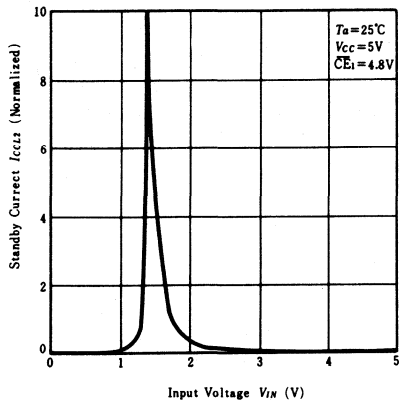

STAND-BY CURRENT vs. INPUT VOLTAGE

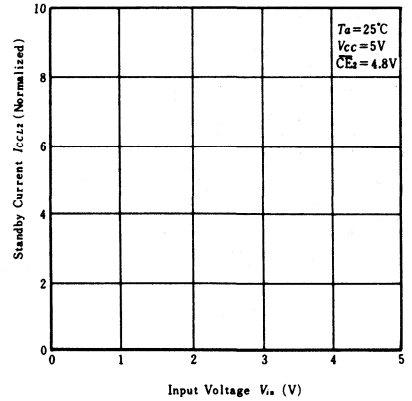

HM6168H-45, HM6168H-55, Under Development HM6168H-70, HM6168HP-45, HM6168HP-55, HM6168HP-70

4096-word × 4-bit High Speed Static CMOS RAM

FEATURES

- High Speed: Fast Access Time 45/55/70 ns (max.)
- Single +5V Supply and High Density 20 Pin Package
- Low Power Standby and Low Power Operation;
100μW typ. (Standby), 250mW typ. (Operation)
- Completely Static Memory
No Clock or Timing Strobe Required
- Equal Access and Cycle Times
- Directly TTL Compatible – All Inputs and Outputs

FUNCTIONAL BLOCK DIAGRAM

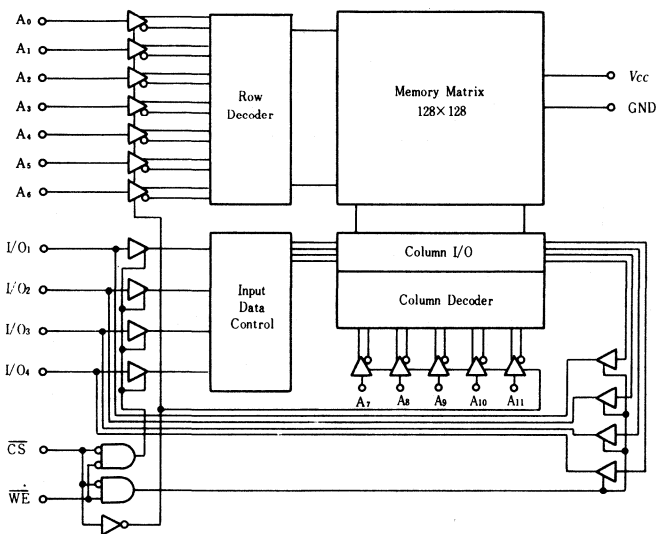

ABSOLUTE MAXIMUM RATINGS

Item	Symbol	Rating	Unit
Voltage on Any Pin Relative to GND	V_{IN}	-3.5* to +7.0	V
Power Dissipation	P_T	1.0	W
Operating Temperature	T_{opr}	0 to +70	°C
Storage Temperature (Ceramic)	T_{stg}	-65 to +150	°C
Storage Temperature (Plastic)	T_{stg}	-55 to +125	°C
Temperature under Bias	T_{bias}	-10 to +85	°C

* Pulse Width 20ns, DC = -0.5V

Note) The specifications of this device are subject to change without notice.
 Please contact your nearest Hitachi Sales Dept. regarding specifications.

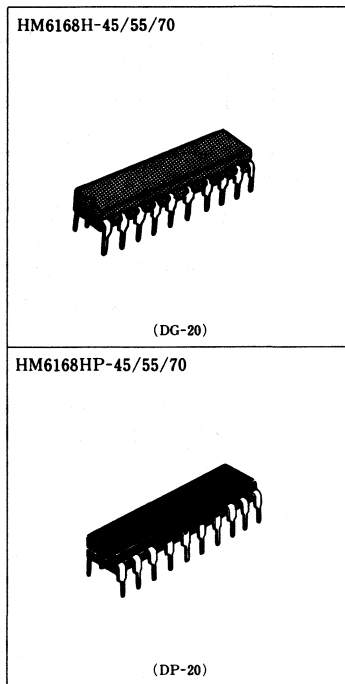

PIN ARRANGEMENT

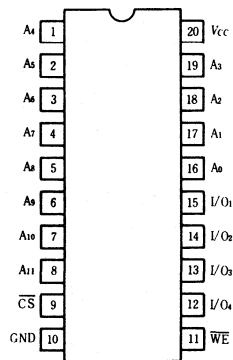

(Top View)

HM6168HLP-45, HM6168HLP-55, HM6168HLP-70 Under Development

4096-word × 4-bit High Speed Static CMOS RAM

FEATURES

- High Speed: Fast Access Time 45/55/70ns(max.)
- Single +5V Supply and High Density 20 Pin Package
- Low Power Standby and Low Power Operation;
5μW typ. (Standby), 250mW typ. (Operation)
- Completely Static Memory
No Clock or Timing Strobe Required
- Equal Access and Cycle Times
- Directly TTL Compatible—All Inputs and Outputs
- Capable of Battery back up Operation

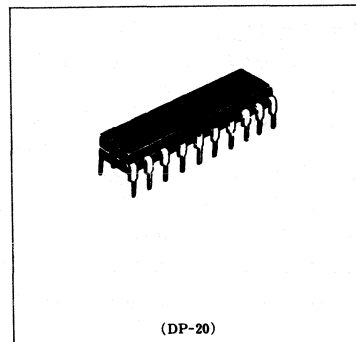

FUNCTIONAL BLOCK DIAGRAM

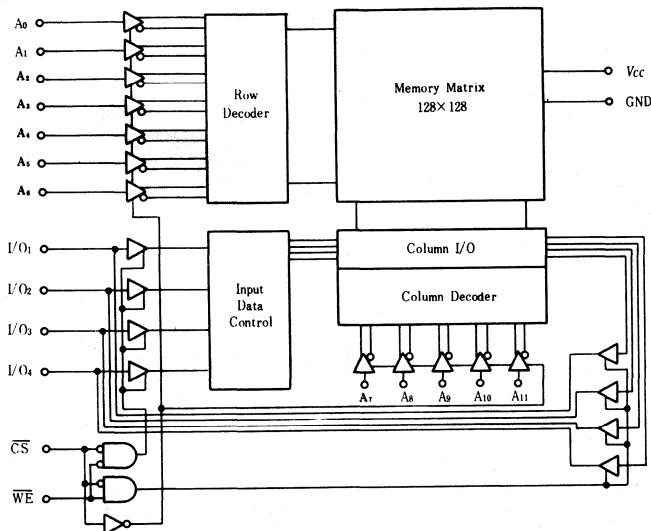

PIN ARRANGEMENT

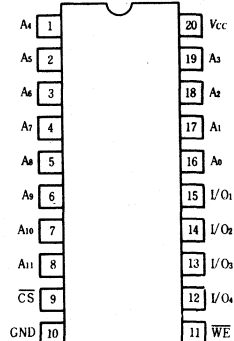

(Top View)

ABSOLUTE MAXIMUM RATINGS

Item	Symbol	Rating	Unit
Voltage on Any Pin Relative to GND	V_{IN}	-3.5* to +7.0	V
Power Dissipation	P_T	1.0	W
Operating Temperature	T_{opr}	0 to +70	°C
Storage Temperature	T_{stg}	-55 to +125	°C
Temperature under Bias	T_{bias}	-10 to +85	°C

* Pulse Width 20ns, DC - 0.5V

Note.) The specifications of this device are subject to change without notice.
Please contact your nearest Hitachi's Sales Dept. regarding specifications.

HM6167, HM6167-6, HM6167-8, HM6167P, HM6167P-6, HM6167P-8

16384-word × 1-bit High Speed Static CMOS RAM

FEATURES

- Single +5V Supply and High Density 20 Pin Package
- Fast Access Time – 70ns/85ns/100ns
- Low Power Stand-by and Low Power Operation
Stand-by 25mW Typ. and Operating 150mW Typ.
- Completely Static Memory No Clock nor Refresh Required
- Fully TTL Compatible – All Inputs and Output
- Separate Data Input and Output Three State Output
- Pin-Out Compatible with Intel 2167 Series

BLOCK DIAGRAM

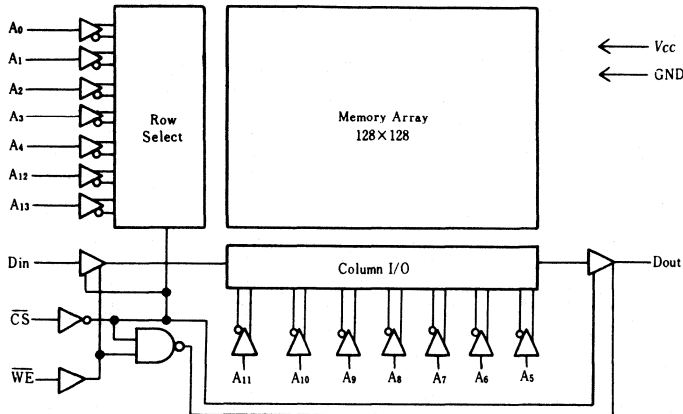

ABSOLUTE MAXIMUM RATINGS

Item	Symbol	Rating	Unit
Terminal Voltage with Respect to GND	V_T	-0.5 to +7.0	V
Power Dissipation	P_T	1.0	W
Operating Temperature	T_{opr}	0 to +70	°C
Storage Temperature(Plastic)	T_{stg}	-55 to +125	°C
Storage Temperature(Ceramic)	T_{stg}	-65 to +150	°C

RECOMMENDED DC OPERATING CONDITIONS

(0°C ≤ Ta ≤ 70°C)

Item	Symbol	min	typ	max	Unit
Supply Voltage	Vcc	4.5	5.0	5.5	V
	GND	0	0	0	V
Input High Voltage	V _{IH}	2.2	—	6.0	V
Input Low Voltage	V _{IL}	-0.5	—	0.8	V

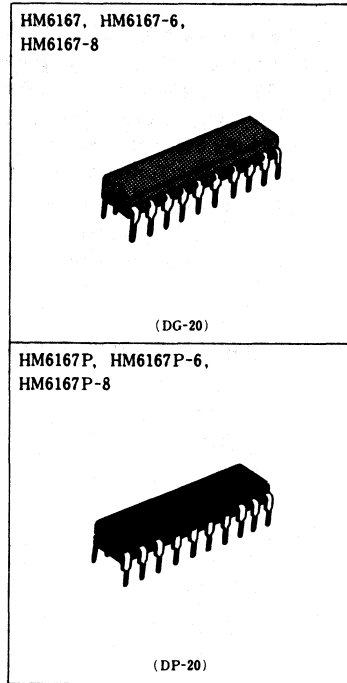

PIN ARRANGEMENT

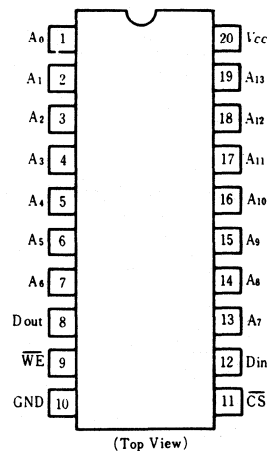

TRUTH TABLE

\overline{CS}	\overline{WE}	Mode	V_{CC} Current	Output Pin	Reference Cycle
H	×	Not Selected	I_{SB}, I_{SB1}	High Z	
L	H	Read	I_{CC}	Dout	Read Cycle 1, 2
L	L	Write	I_{CC}	High Z	Write Cycle 1, 2

DC AND OPERATING CHARACTERISTICS ($V_{CC}=5V \pm 10\%$, $T_a=0^\circ C$ to $+70^\circ C$)

Item	Symbol	Test Conditions	min	typ	max	Unit
Input Leakage Current	$ I_{LI} $	$V_{CC}=5.5V, V_{IN}=0V \sim V_{CC}$	—	—	2	μA
Output Leakage Current	$ I_{LO} $	$\overline{CS}=V_{IH}, V_{OUT}=0V \sim V_{CC}$	—	—	2	μA
Operating Power Supply Current	I_{CC}	$\overline{CS}=V_{IL}$, Output Open	—	30	60	mA
Standby Power Supply Current	I_{SB}	$\overline{CS}=V_{IH}$	—	5	20	mA
	I_{SB1}	$\overline{CS}=V_{CC}-0.2V$ $V_{IN} \leq 0.2V$ or $\geq V_{CC}-0.2V$	—	0.02	2	mA
Output Low Voltage	V_{OL}	$I_{OL}=8mA$	—	—	0.4	V
Output High Voltage	V_{OH}	$I_{OH}=-4mA$	2.4	—	—	V

Note) Typical limits are at $V_{CC}=5.0V, T_a=25^\circ C$ and specified loading.

AC TEST CONDITIONS

Input pulse levels: GND to 3.0V
 Input rise and fall times: 5 ns
 Input timing reference levels: 1.5V
 Output reference levels: 1.5V
 Output load: See Figure

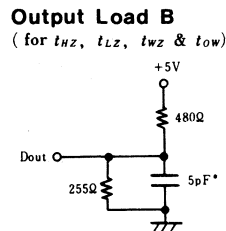
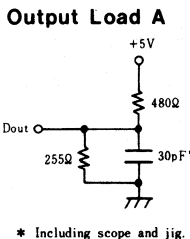

CAPACITANCE ($T_a=25^\circ C, f=1.0MHz$)

Item	Symbol	max	Unit	Conditions
Input Capacitance	C_{IN}	5	pF	$V_{IN}=0V$
Output Capacitance	C_{OUT}	6	pF	$V_{OUT}=0V$

Note) This parameter is sampled and not 100% tested.

AC CHARACTERISTICS ($V_{CC}=5V \pm 10\%$, $T_a=0^\circ C$ to $70^\circ C$, unless otherwise noted.)

READ CYCLE

Item	Symbol	HM6167, HM6167P		HM6167-6, HM6167P-6		HM6167-8, HM6167P-8		Unit
		min	max	min	max	min	max	
Read Cycle Time	t_{RC}	70	—	85	—	100	—	ns
Address Access Time	t_{AA}	—	70	—	85	—	100	ns
Chip Select Access Time	t_{ACS}	—	70	—	85	—	100	ns
Output Hold from Address Change	t_{OH}	5	—	5	—	5	—	ns
Chip Selection to Output in Low Z	t_{LZ}	5	—	5	—	5	—	ns
Chip Deselection to Output in High Z	t_{HZ}	0	30	0	40	0	40	ns
Chip Selection to Power Up Time	t_{PU}	0	—	0	—	0	—	ns
Chip Deselection to Power Down Time	t_{PD}	—	35	—	40	—	45	ns

● WRITE CYCLE

Item	Symbol	HM6167, HM6167P		HM6167-6, HM6167P-6		HM6167-8, HM6167P-8		Unit	Notes
		min	max	min	max	min	max		
Write Cycle Time	t_{WC}	70	—	85	—	100	—	ns	2
Chip Selection to End of Write	t_{CW}	55	—	65	—	80	—	ns	
Address Valid to End of Write	t_{AW}	55	—	65	—	80	—	ns	
Address Setup Time	t_{AS}	0	—	0	—	0	—	ns	
Write Pulse Width	t_{WP}	40	—	45	—	55	—	ns	
Write Recovery Time	t_{WR}	0	—	0	—	0	—	ns	
Data Valid to End of Write	t_{DW}	30	—	35	—	40	—	ns	
Data Hold Time	t_{DH}	0	—	0	—	0	—	ns	
Write Enable to Output in High Z	t_{WZ}	0	30	0	40	0	40	ns	3, 4
Output Active from End of Write	t_{OW}	0	—	0	—	0	—	ns	3, 4

- Notes) 1. If \overline{CS} goes high simultaneously with \overline{WE} high, the output remains in a high impedance state.
 2. All Write Cycle timings are referenced from the last valid address to the first transitioning address.
 3. Transition is measured $\pm 500\text{mV}$ from steady state voltage with specified loading in Load B.
 4. This parameter is sampled and not 100% tested.

● TIMING WAVEFORM OF READ CYCLE NO.1 ^{1), 2)}

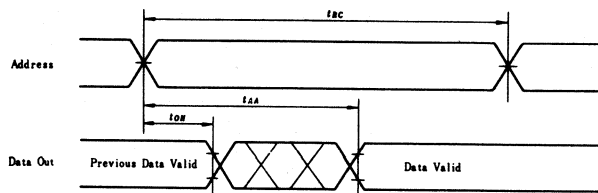

● TIMING WAVEFORM OF READ CYCLE NO.2 ^{1), 3)}

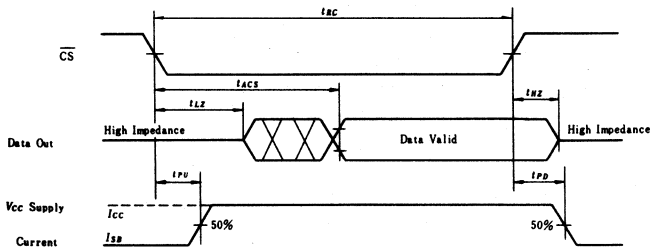

- NOTES: 1. \overline{WE} is high and \overline{CS} is low for READ cycle.
 2. Addresses valid prior to or coincident with \overline{CS} transition low.
 3. Transition is measured $\pm 500\text{mV}$ from steady state voltage with specified loading in Load B.

●TIMING WAVEFORM OF WRITE CYCLE NO.1 (\overline{WE} Controlled)

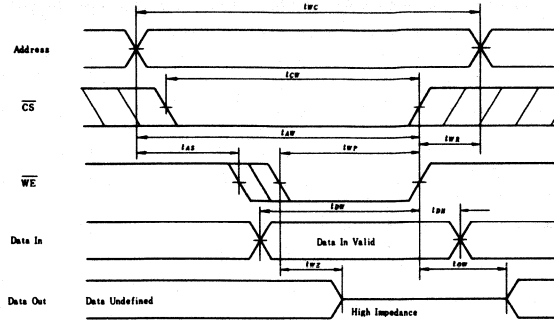

NOTE: 1. Transition is measured $\pm 500\text{mV}$ from steady state voltage with specified loading in Load B.

●TIMING WAVEFORM OF WRITE CYCLE No. 2 (\overline{CS} Controlled)

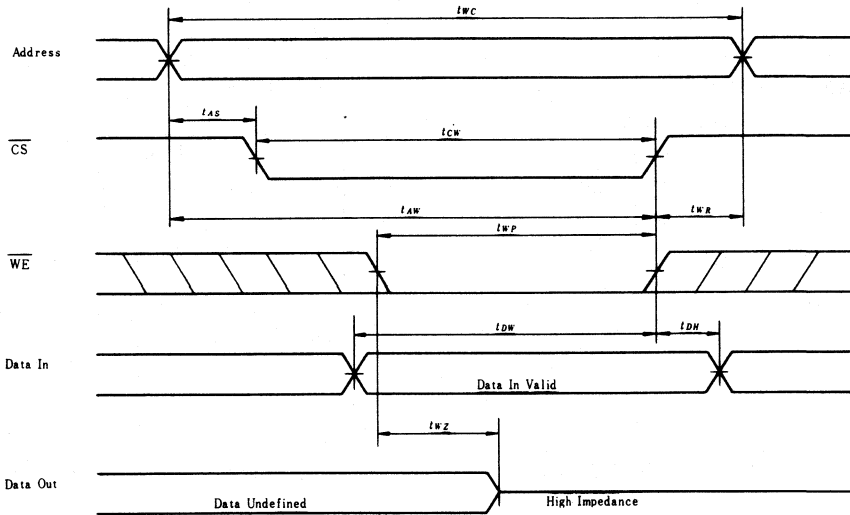

Note) Transition is measured $\pm 500\text{mV}$ from steady state voltage with specified loading in Load B.

SUPPLY CURRENT vs. SUPPLY VOLTAGE

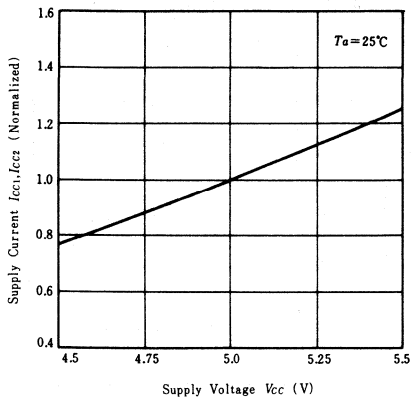

SUPPLY CURRENT vs. AMBIENT TEMPERATURE

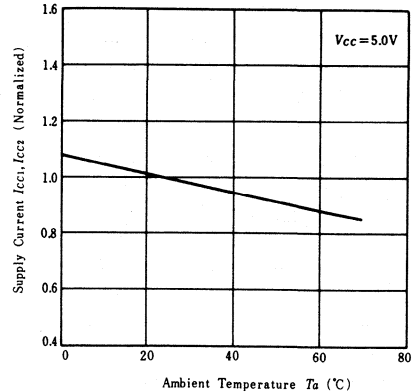

**ACCESS TIME vs.
SUPPLY VOLTAGE**

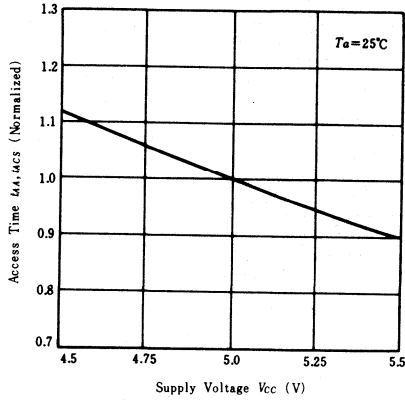

**ACCESS TIME vs.
AMBIENT TEMPERATURE**

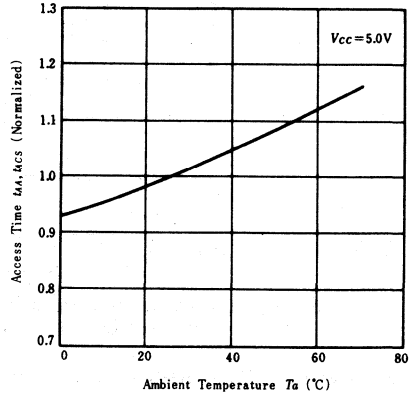

**ACCESS TIME vs.
LOAD CAPACITANCE**

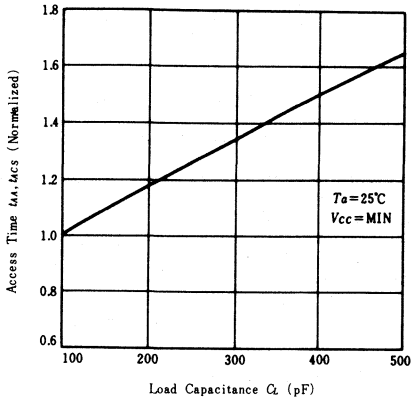

**SUPPLY CURRENT vs.
FREQUENCY**

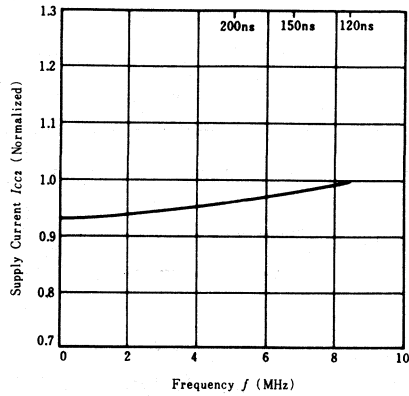

**INPUT LOW VOLTAGE vs.
SUPPLY VOLTAGE**

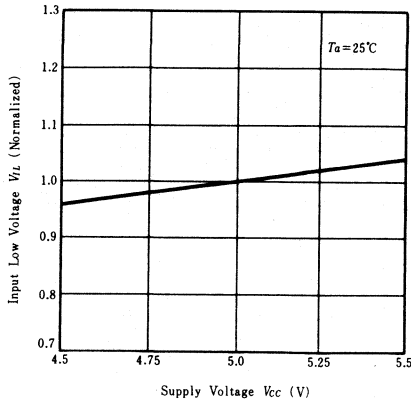

**INPUT HIGH VOLTAGE vs.
SUPPLY VOLTAGE**

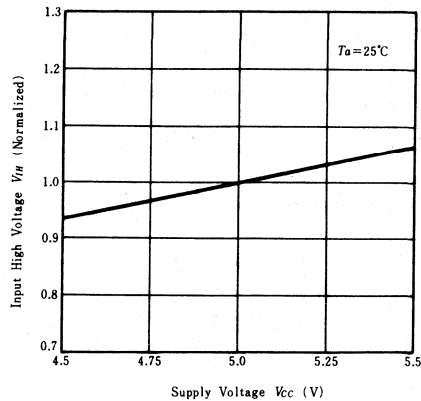

**OUTPUT HIGH CURRENT vs.
OUTPUT HIGH VOLTAGE**

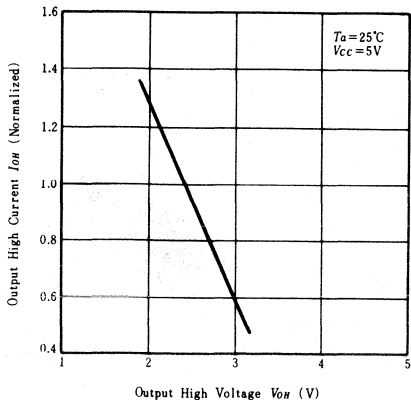

**OUTPUT LOW CURRENT vs.
OUTPUT LOW VOLTAGE**

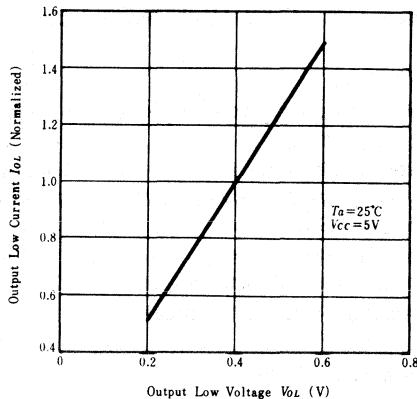

**STANDBY CURRENT vs.
AMBIENT TEMPERATURE**

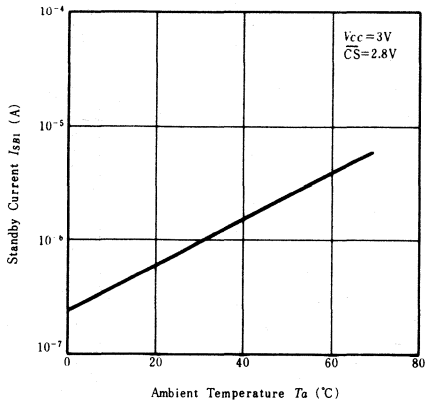

**STANDBY CURRENT vs.
SUPPLY VOLTAGE**

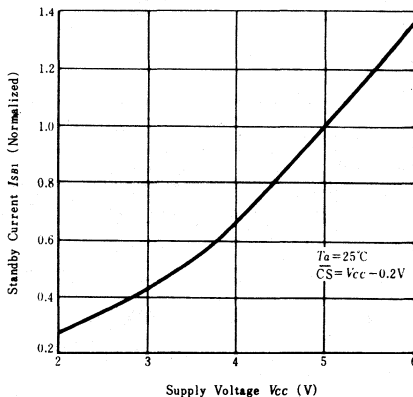

**STANDBY CURRENT vs.
INPUT VOLTAGE**

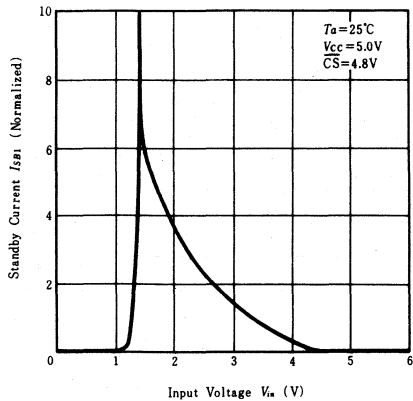

HM6167LP, HM6167LP-6, HM6167LP-8

16384-word × 1-bit High Speed Static CMOS RAM

■ FEATURES

- Single +5V Supply and High Density 20 Pin Package
- Fast Access Time 70ns/85ns/100ns
- Low Power Stand-by and Low Power Operation
Stand-by 5μW (typ) and Operating 150mW (typ.)
- Completely Static Memory. No Clock or Refresh Required
- Fully TTL Compatible. All Inputs and Output
- Separate Data Input and Output Three State Output
- Capable of Battery Back up Operation

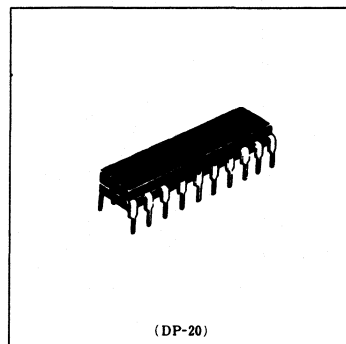

■ BLOCK DIAGRAM

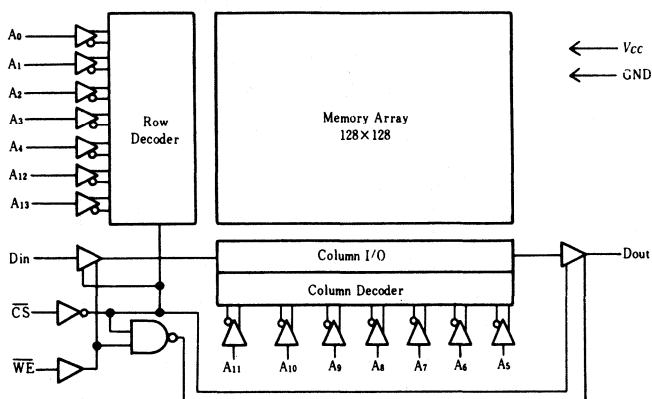

■ PIN ARRANGEMENT

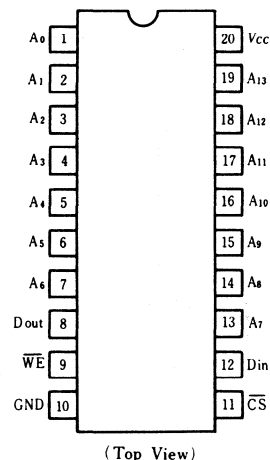

■ ABSOLUTE MAXIMUM RATINGS

Item	Symbol	Rating	Unit
Terminal Voltage with Respect to GND	V_T	-0.5 to +7.0	V
Power Dissipation	P_T	1.0	W
Operating Temperature	T_{op}	0 to +70	°C
Storage Temperature	T_{stg}	-55 to +125	°C

■ RECOMMENDED DC OPERATING CONDITIONS (0°C ≤ Ta ≤ 70°C)

Item	Symbol	min	typ	max	Unit
Supply Voltage	V_{CC}	4.5	5.0	5.5	V
	GND	0	0	0	V
Input High Voltage	V_{IH}	2.2	—	6.0	V
Input Low Voltage	V_{IL}	-0.5	—	0.8	V

TRUTH TABLE

CS	WE	Mode	V _{CC} Current	Output Pin	Reference Cycle
H	×	Not Selected	I _{SB} , I _{SB1}	High Z	
L	H	Read	I _{CC}	Dout	Read Cycle 1, 2
L	L	Write	I _{CC}	High Z	Write Cycle 1, 2

DC AND OPERATING CHARACTERISTICS (V_{CC}=5V±10%, T_a=0~+70°C)

Item	Symbol	Test Conditions	min	typ	max	Unit
Input Leakage Current	I _{LI}	V _{CC} =5.5V V _{IN} =0V~V _{CC}	—	—	2	μA
Output Leakage Current	I _{LO}	CS=V _{HH} , V _{OUT} =0V~V _{CC}	—	—	2	μA
Operating Power Supply Current	I _{CC}	CS=V _{LL} , Output Open	—	30	60	mA
Standby Power Supply Current	I _{SB}	CS=V _{HH}	—	5	20	mA
	I _{SB1}	CS=V _{CC} -0.2V V _{IN} ≤0.2V or ≥V _{CC} -0.2V	—	1	50	μA
Output Low Voltage	V _{OL}	I _{OL} =8mA	—	—	0.4	V
Output High Voltage	V _{OH}	I _{OH} =-4mA	2.4	—	—	V

Note) Typical limits are at V_{CC}=5.0V, T_a=25°C and specified loading.

AC TEST CONDITIONS

Input pulse levels: GND to 3.0V
 Input rise and fall times: 5 ns
 Input timing reference levels: 1.5V
 Output reference levels: 1.5V
 Output load: See Figure

Output Load A

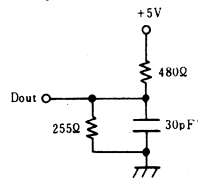

* Including scope and jig.

Output Load B

(for t_{HZ}, t_{LZ}, t_{wz} & t_{ow})

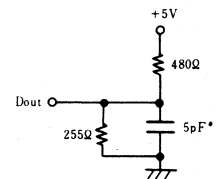

CAPACITANCE (T_a=25°C, f=1.0MHz)

Item	Symbol	max	Unit	Conditions
Input Capacitance	C _{IN}	5	pF	V _{IN} =0V
Output Capacitance	C _{OUT}	6	pF	V _{OUT} =0V

Note) This parameter is sampled and not 100% tested.

AC CHARACTERISTICS (T_a=0°C to +70°C, V_{CC}=5V±10%, unless otherwise noted.)

READ CYCLE

Item	Symbol	HM6167LP		HM6167LP-6		HM6167LP-8		Unit
		min	max	min	max	min	max	
Read Cycle Time	t _{RC}	70	—	85	—	100	—	ns
Address Access Time	t _{AA}	—	70	—	85	—	100	ns
Chip Select Access Time	t _{ACS}	—	70	—	85	—	100	ns
Output Hold from Address Change	t _{OH}	5	—	5	—	5	—	ns
Chip Selection to Output in Low Z	t _{LZ}	5	—	5	—	5	—	ns
Chip Deselection to Output in High Z	t _{HZ}	0	30	0	40	0	40	ns
Chip Selection to Power Up Time	t _{PU}	0	—	0	—	0	—	ns
Chip Deselection to Power Down Time	t _{PD}	—	35	—	40	—	45	ns

● TIMING WAVEFORM OF READ CYCLE NO.1 ^{1), 2)}

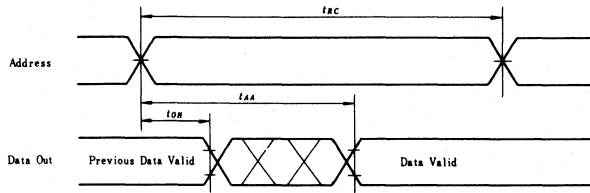

● TIMING WAVEFORM OF READ CYCLE NO.2 ^{1), 3)}

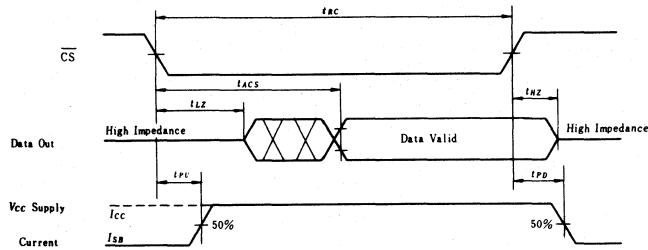

- NOTES: 1. \overline{WE} is high and \overline{CS} is low for READ Cycle.
 2. Addresses valid prior to or coincident with \overline{CS} transition low.
 3. Transition is measured $\pm 500\text{mV}$ from steady state voltage with specified loading B.

● WRITE CYCLE

Item	Symbol	HM6167LP		HM6167LP-6		HM6167LP-8		Unit	Notes
		min	max	min	max	min	max		
Write Cycle Time	t_{WC}	70	—	85	—	100	—	ns	2
Chip Selection to End of Write	t_{CW}	55	—	65	—	80	—	ns	
Address Valid to End of Write	t_{AW}	55	—	65	—	80	—	ns	
Address Setup Time	t_{AS}	0	—	0	—	0	—	ns	
Write Pulse Width	t_{WP}	40	—	45	—	55	—	ns	
Write Recovery Time	t_{WR}	0	—	0	—	0	—	ns	
Data Valid to End of Write	t_{DW}	30	—	35	—	40	—	ns	
Data Hold Time	t_{DH}	0	—	0	—	0	—	ns	
Write Enable to Output in High Z	t_{WZ}	0	30	0	40	0	40	ns	3, 4
Output Active from End of Write	t_{OW}	0	—	0	—	0	—	ns	3, 4

- Notes) 1. If \overline{CS} goes high simultaneously with \overline{WE} high, the output remains in a high impedance state.
 2. All Write Cycle timings are referenced from the last valid address to the first transitioning address.
 3. Transition is measured $\pm 500\text{mV}$ from steady state voltage with specified loading in Load B.
 4. This parameter is sampled and not 100% tested.

● TIMING WAVEFORM OF WRITE CYCLE NO.1 (\overline{WE} Controlled)

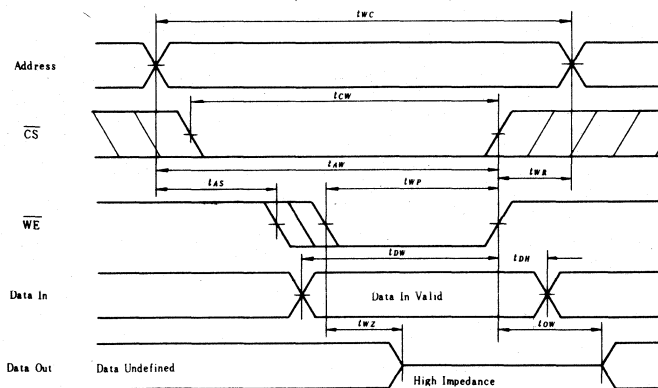

● TIMING WAVEFORM OF WRITE CYCLE No. 2 (\overline{CS} Controlled)

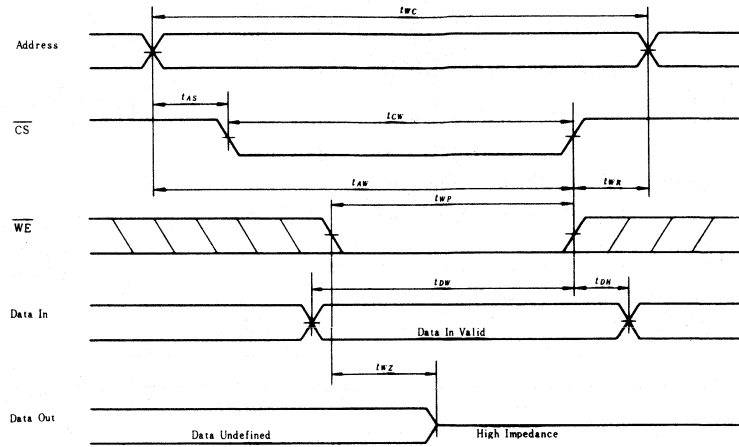

■ LOW V_{CC} DATA RETENTION CHARACTERISTICS ($T_a=0^\circ\text{C}$ to 70°C)

Parameter	Symbol	Test Condition	min	typ	max	Unit
V_{CC} for Data Retention	V_{DR}		2.0	—	—	V
Data Retention Current	I_{CCDR}	$\overline{CS} \geq V_{CC} - 0.2V$ $V_{i1} \geq V_{CC} - 0.2V$ or $0V \leq V_{i1} \leq 0.2V$	—	—	20*	μA
Chip Deselect to Data Retention Time	t_{CDR}		0	—	—	ns
Operation Recovery Time	t_R		t_{RC}^Δ	—	—	ns

Δt_{RC} = Read Cycle Time

* $V_{CC} = 2.0V$
** $V_{CC} = 3.0V$

■ LOW V_{CC} DATA RETENTION WAVEFORM

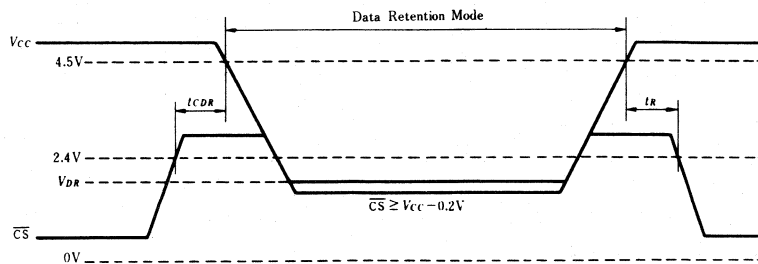

HM6167H-45, HM6167H-55, HM6167HP-45, HM6167HP-55

16384-word x 1-bit High Speed Static CMOS RAM

■ FEATURES

- Fast Access Time.HM6167H/P-45 45ns (max)
HM6167H/P-55 55ns (max)
- Low Power Standby and Low Power Operation
Standby 100 μ W (typ), Operating 200mW (typ)
- Single +5V Supply and High Density 20 Pin Package
- Completely Static Memory . . . No Clock nor Refresh Required
- Fully TTL CompatibleAll Inputs and Output
- Separate Data Input and Output.Three State Output

■ BLOCK DIAGRAM

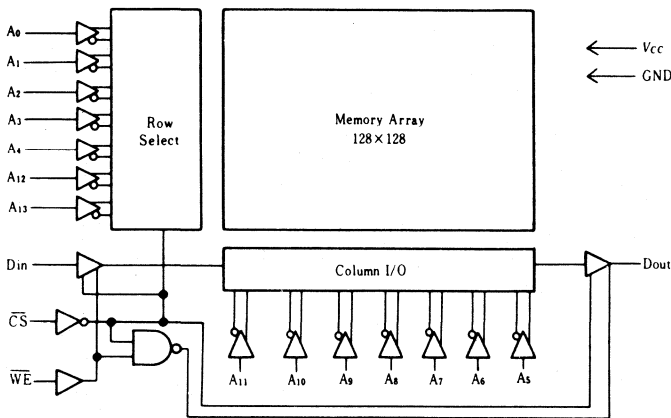

■ ABSOLUTE MAXIMUM RATINGS

Item	Symbol	Rating	Unit
Terminal Voltage with respect to GND	V_T	-3.5* to +7.0	V
Power Dissipation	P_T	1.0	W
Operating Temperature	T_{opr}	0 to +70	°C
Storage Temperature (Plastic)	T_{stg}	-55 to +125	°C
Storage Temperature (Ceramic)	T_{stg}	-65 to +150	°C
Storage Temperature (under bias)	T_{bias}	-10 to +85	°C

* Pulse Width 20ns, DC: -0.5V

■ RECOMMENDED DC OPERATING CONDITIONS ($T_a = 0$ to +70°C)

Item	Symbol	min	typ	max	Unit
Supply Voltage	V_{CC}	4.5	5.0	5.5	V
	GND	0	0	0	V
Input Voltage	V_{IH}	2.2	-	6.0	V
	V_{IL}	-3.0*	-	0.8	V

* Pulse Width: 20ns, DC: V_{IL} (min) = -0.5V

HM6167H-45, HM6167H-55

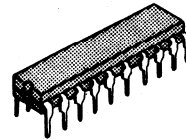

(DG-20)

HM6167HP-45, HM6167HP-55

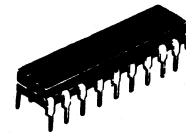

(DP-20)

■ PIN ARRANGEMENT

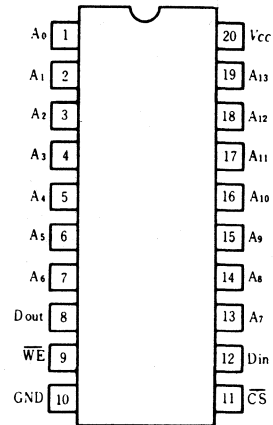

(Top View)

■ TRUTH TABLE

\overline{CS}	\overline{WE}	Mode	V_{CC} Current	Dout Pin	Ref. Cycle
H	×	Not selected	I_{SB}, I_{SB1}	High-Z	
L	H	Read	I_{CC}	Dout	Read Cycle
L	L	Write	I_{CC}	High-Z	Write Cycle

■ DC AND OPERATING CHARACTERISTICS ($V_{CC}=5V \pm 10\%$, $T_a=0^\circ C$ to $+70^\circ C$)

Item	Symbol	Test Conditions	min	typ	max	Unit
Input Leakage Current	$ I_{LI} $	$V_{CC}=5.5V, V_{IN}=0V \sim V_{CC}$	—	—	2	μA
Output Leakage Current	$ I_{LO} $	$\overline{CS}=V_{IH}, V_{OUT}=0V \sim V_{CC}$	—	—	2	μA
Operating Power Supply Current	I_{CC}	$\overline{CS}=V_{IL}$, Output Open	—	40	80	mA
Standby Power Supply Current	I_{SB}	$\overline{CS}=V_{IH}$	—	10	20	mA
	I_{SB1}	$\overline{CS} \geq V_{CC}-0.2V$ $V_{IN} \leq 0.2V$ or $\geq V_{CC}-0.2V$	—	0.02	2	mA
Output Low Voltage	V_{OL}	$I_{OL}=8mA$	—	—	0.4	V
Output High Voltage	V_{OH}	$I_{OH}=-4mA$	2.4	—	—	V

Note) Typical limits are at $V_{CC}=5.0V, T_a=25^\circ C$ and specified loading.

■ AC TEST CONDITIONS

Input pulse levels: GND to 3.0V
 Input rise and fall times: 5 ns
 Input timing reference levels: 1.5V
 Output reference levels: 1.5V
 Output load: See Figure

Output Load A

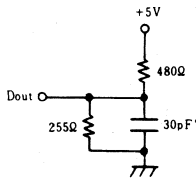

* Including scope and jig.

Output Load B

(for t_{HZ}, t_{LZ}, t_{WZ} & t_{OW})

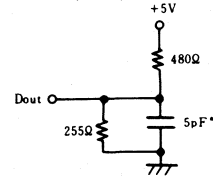

* Including scope and jig.

■ CAPACITANCE ($T_a=25^\circ C, f=1.0MHz$)

Item	Symbol	typ	max	Unit	Conditions
Input Capacitance	C_{IN}	3	5	pF	$V_{IN}=0V$
Output Capacitance	C_{OUT}	5	7	pF	$V_{OUT}=0V$

Note) This parameter is sampled and not 100% tested.

■ AC CHARACTERISTICS ($V_{CC}=5V \pm 10\%$, $T_a=0^\circ\text{C}$ to 70°C , unless otherwise noted.)

● READ CYCLE

Item	Symbol	HM6167H/P-45		HM6167HP-55		Unit	Notes
		min	max	min	max		
Read Cycle Time	t_{RC}	45	—	55	—	ns	(1)
Address Access Time	t_{AA}	—	45	—	55	ns	
Chip Select Access Time	t_{ACS}	—	45	—	55	ns	
Output Hold from Address Change	t_{OH}	5	—	5	—	ns	
Chip Selection to Output in Low Z	t_{LZ}	5	—	5	—	ns	(2) (3) (7)
Chip Deselection to Output in High Z	t_{HZ}	0	30	0	30	ns	(2) (3) (7)
Chip Selection to Power Up Time	t_{PU}	0	—	0	—	ns	
Chip Deselection to Power Down Time	t_{PD}	—	30	—	30	ns	

- NOTES: 1. All Read Cycle timing are referenced from last valid address to the first transitioning address.
 2. At any given temperature and voltage condition, t_{HZ} max. is less than t_{LZ} min. both for a given device and from device to device.
 3. Transition is measured $\pm 500\text{mV}$ from steady state voltage with specified loading in Load B.
 4. \overline{WE} is High for READ cycle.
 5. Device is continuously selected, $\overline{CS} = V_{IL}$.
 6. Addresses valid prior to or coincident with \overline{CS} transition low.
 7. This parameter is sampled and not 100% tested.

● TIMING WAVEFORM OF READ CYCLE NO.1 (4), 5)

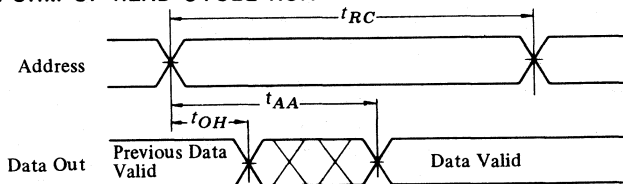

● TIMING WAVEFORM OF READ CYCLE NO.2 (4), 6)

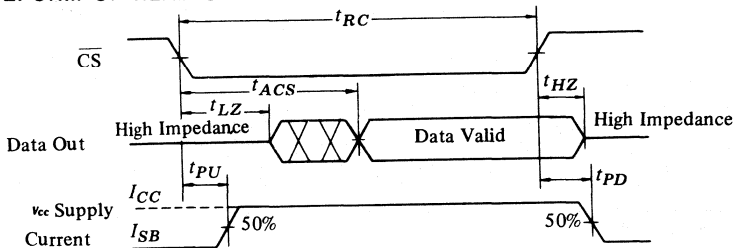

• WRITE CYCLE

Item	Symbol	HM6167H/P-45		HM6167H/P-55		Unit	Notes
		min	max	min	max		
Write Cycle Time	t_{WC}	45	—	55	—	ns	(2)
Chip Selection to End of Write	t_{CW}	40	—	50	—	ns	
Address Valid to End of Write	t_{AW}	40	—	50	—	ns	
Address Setup Time	t_{AS}	0	—	0	—	ns	
Write Pulse Width	t_{WP}	25	—	35	—	ns	
Write Recovery Time	t_{WR}	0	—	0	—	ns	
Data Valid to End of Write	t_{DW}	25	—	25	—	ns	
Data Hold Time	t_{DH}	0	—	0	—	ns	
Write Enable to Output in High Z	t_{WZ}	0	25	0	25	ns	(3) (4)
Output Active from End of Write	t_{OW}	0	—	0	—	ns	(3) (4)

- NOTES: 1. If \overline{CS} goes high simultaneously with \overline{WE} high, the output remains in a high impedance states.
 2. All write cycle timings are referenced from the last valid address to the first transitioning address.
 3. Transition is measured $\pm 500mV$ from steady state voltage with specified loading in Load B.
 4. This parameter is sampled and not 100% tested.

• TIMING WAVEFORM OF WRITE CYCLE (\overline{WE} Controlled)

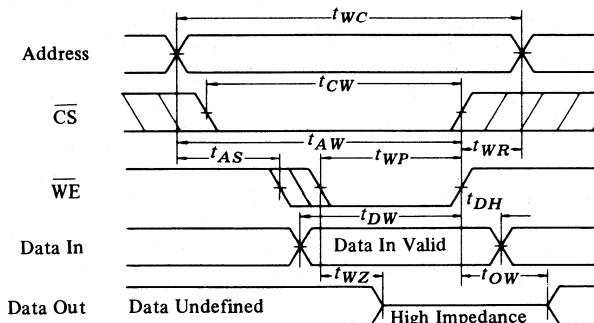

• TIMING WAVEFORM OF WRITE CYCLE (\overline{CS} Controlled)

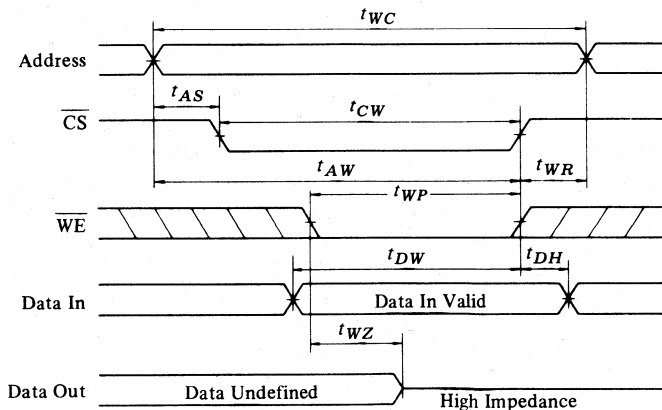

SUPPLY CURRENT vs. SUPPLY VOLTAGE

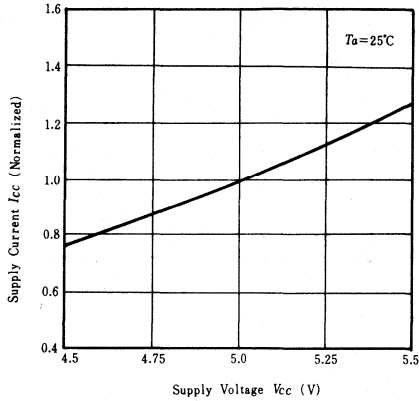

SUPPLY CURRENT vs. AMBIENT TEMPERATURE

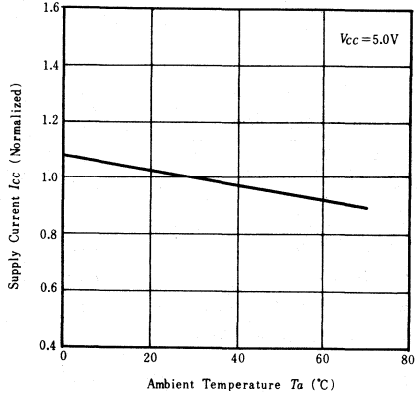

ACCESS TIME vs. SUPPLY VOLTAGE

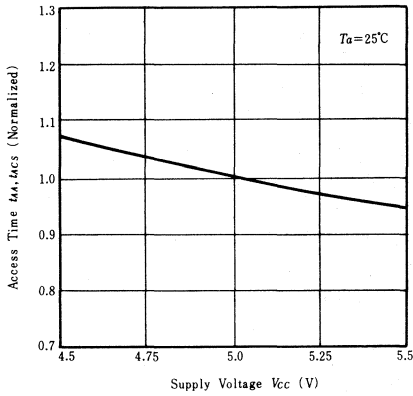

ACCESS TIME vs. AMBIENT TEMPERATURE

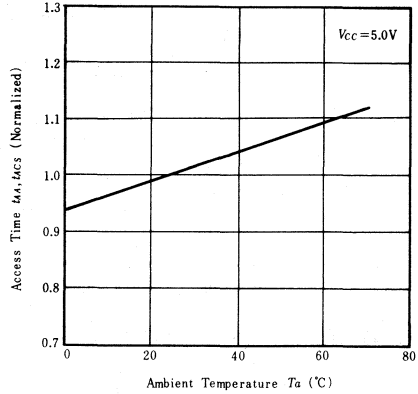

ACCESS TIME vs. LOAD CAPACITANCE

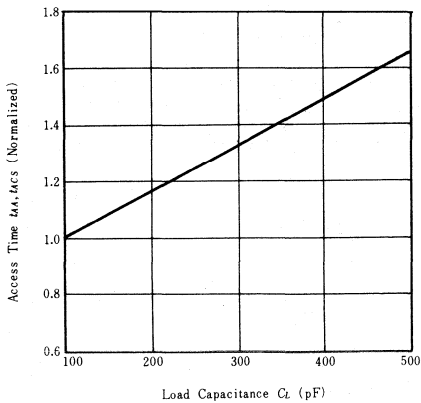

SUPPLY CURRENT vs. FREQUENCY

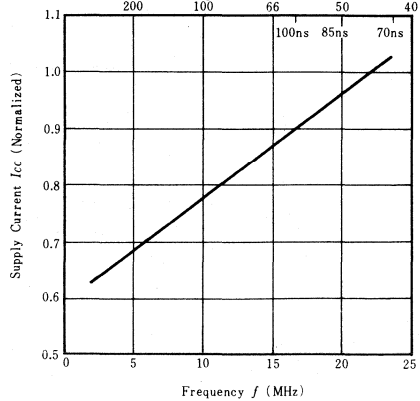

INPUT LOW VOLTAGE vs. SUPPLY VOLTAGE

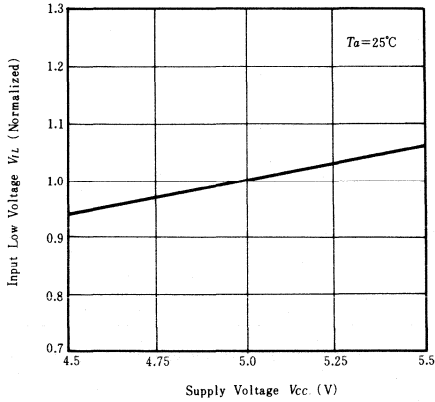

INPUT HIGH VOLTAGE vs. SUPPLY VOLTAGE

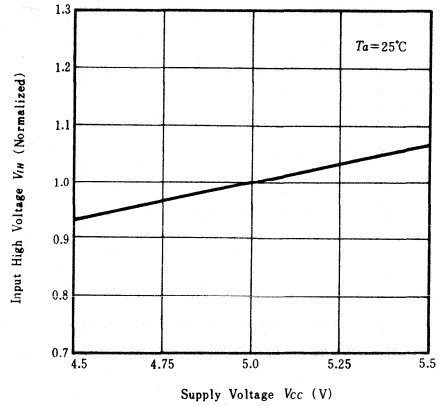

OUTPUT CURRENT vs. OUTPUT VOLTAGE

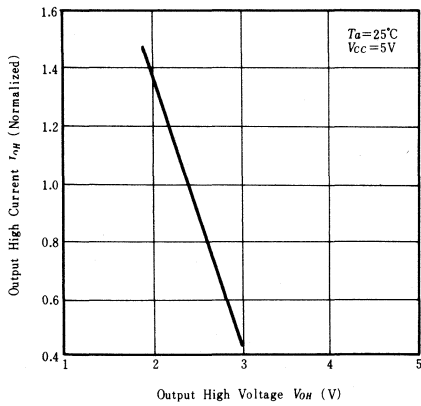

OUTPUT CURRENT vs. OUTPUT VOLTAGE

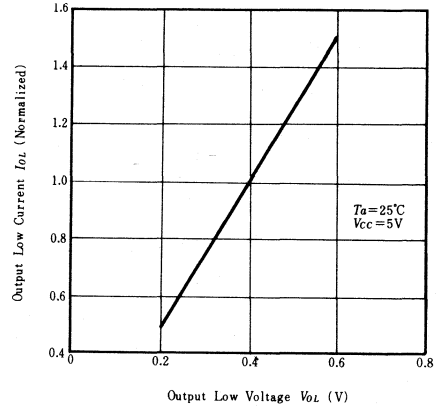

STANDBY CURRENT vs. AMBIENT TEMPERATURE

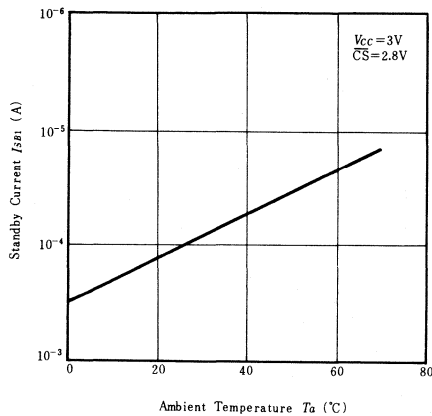

STANDBY CURRENT vs. SUPPLY VOLTAGE

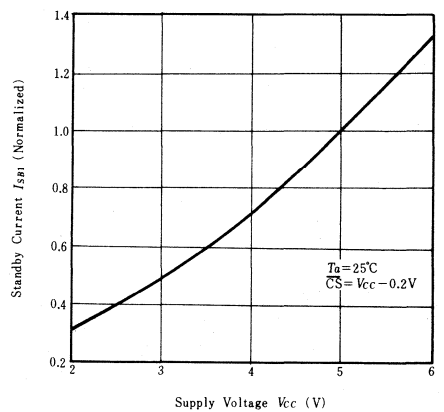

**STANDBY CURRENT vs.
INPUT VOLTAGE**

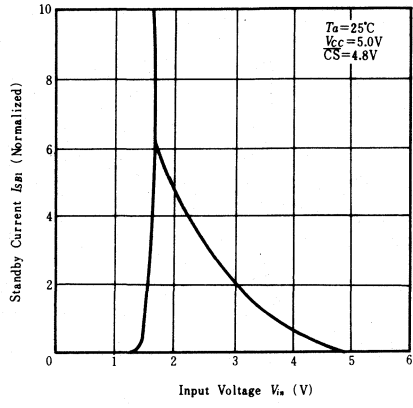

HM6167HCG-45, HM6167HCG-55

16384-word × 1-bit High Speed Static CMOS RAM

FEATURES

- High Density 20 pin Leadless Chip Carrier
- High Speed: Fast Access Time 45/55ns Max.
- Low Power Standby and Low Power Operation
Standby: 100μW typ., Operation: 200mW typ.
- Completely Static Memory;
No Clock or Timing Strobe Required
- Equal Access and Cycle Times
- Directly TTL Compatible; All Inputs and Output

BLOCK DIAGRAM

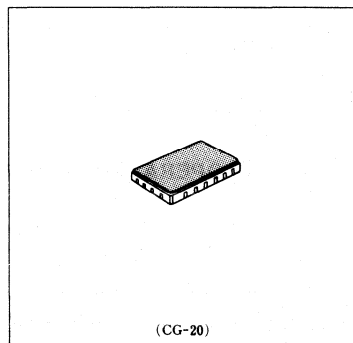
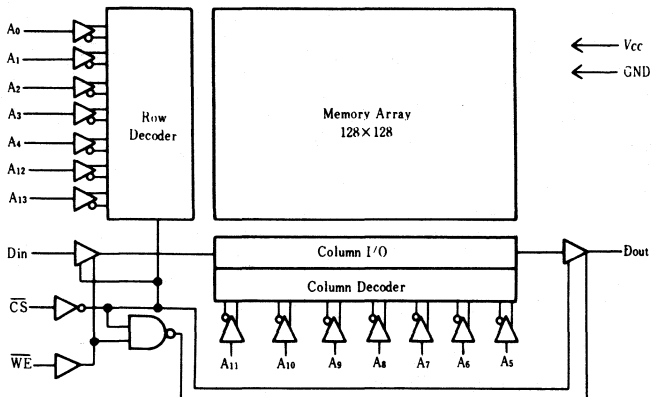

PIN ARRANGEMENT

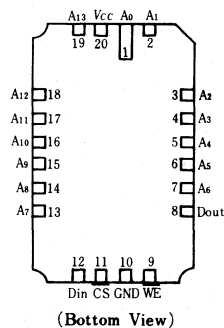

ABSOLUTE MAXIMUM RATINGS

Item	Symbol	Rating	Unit
Voltage on Any Pin*	V_T	-0.5 to +7.0	V
Power Dissipation	P_T	1.0	W
Operating Temperature	T_{opr}	0 to +70	°C
Storage Temperature	T_{stg}	-65 to +150	°C
Temperature Under Bias	T_{bia}	-10 to +85	°C

* with respect to GND. $V_{IN} \text{ min} = -3.5\text{V}$ (Pulse width 20ns)

TRUTH TABLE

CS	WE	Mode	V_{CC} Current	Dout Pin	Ref. Cycle
H	×	Not selected	I_{SB}, I_{SB1}	High-Z	
L	H	Read	I_{CC}	Dout	Read Cycle
L	L	Write	I_{CC}	High-Z	Write Cycle

■ RECOMMENDED DC OPERATING CONDITIONS ($T_a=0$ to $+70^\circ\text{C}$)

Item	Symbol	min	typ	max	Unit
Supply Voltage	V_{CC}	4.5	5.0	5.5	V
	GND	0	0	0	V
Input Voltage	V_{IH}	2.2	—	6.0	V
	V_{IL}	-0.5*	—	0.8	V

* -3.0V (Pulse width 20ns)

■ DC AND OPERATING CHARACTERISTICS ($V_{CC}=5V \pm 10\%$, $T_a=0$ to $+70^\circ\text{C}$)

Item	Symbol	Test Conditions	min	typ*	max	Unit
Input Leakage Current	$ I_{LI} $	$V_{CC}=5.5V, V_{IN}=0V$ to V_{CC}	—	—	2	μA
Output Leakage Current	$ I_{LO} $	$\overline{\text{CS}}=V_{IH}, V_{OUT}=0V$ to V_{CC}	—	—	2	μA
Operating Power Supply Current	I_{CC}	$\overline{\text{CS}}=V_{IL}$, Output Open	—	40	80	mA
Standby Power Supply Current	I_{SB}	$\overline{\text{CS}}=V_{IH}$	—	10	20	mA
	I_{SB1}	$\overline{\text{CS}} \geq V_{CC}-0.2V, V_{IN} \leq 0.2V$ or $V_{IN} \geq V_{CC}-0.2V$	—	20	2000	μA
Output Voltage	V_{OL}	$I_{OL}=8\text{mA}$	—	—	0.4	V
	V_{OH}	$I_{OH}=-4\text{mA}$	2.4	—	—	V

Note) *: Typical limits are at $V_{CC}=5.0V, T_a=25^\circ\text{C}$ and specified loading.

■ CAPACITANCE ($T_a=25^\circ\text{C}, f=1\text{MHz}$)

Item	Symbol	Test Conditions	typ	max	Unit
Input Capacitance	C_{in}	$V_{in}=0V$	3	5	pF
Output Capacitance	C_{out}	$V_{out}=0V$	5	7	pF

Note) This parameter is sampled and not 100% tested.

■ AC CHARACTERISTICS ($V_{CC}=5V \pm 10\%$, $T_a=0$ to $+70^\circ\text{C}$)

● AC TEST CONDITIONS

Input Pulse Levels: GND to 3.0V

Input Rise and Fall Times: 5 ns

Output Reference Levels: 1.5V

Output Load A

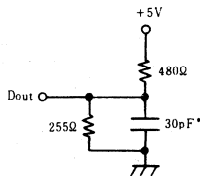

Output Load B

(for t_{HZ}, t_{LZ}, t_{wz} & t_{ow})

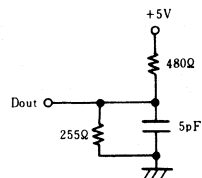

* Including scope and jig.

● READ CYCLE

Item	Symbol	HM6167HCG-45		HM6167HCG-55		Unit	Notes
		min	max	min	max		
Read Cycle Time	t_{RC}	45	—	55	—	ns	1
Address Access Time	t_{AA}	—	45	—	55	ns	
Chip Select Access Time	t_{ACS}	—	45	—	55	ns	
Output Hold from Address Change	t_{OH}	5	—	5	—	ns	
Chip Selection to Output in Low Z	t_{LZ}	5	—	5	—	ns	2, 3, 4
Chip Deselection to Output in High Z	t_{HZ}	0	30	0	30	ns	2, 3, 4
Chip Selection to Power Up Time	t_{PU}	0	—	0	—	ns	
Chip Deselection to Power Down Time	t_{PD}	—	30	—	30	ns	

Notes) 1. All Read Cycle timings are referenced from last valid address to the first transitioning address.
 2. At any given temperature and voltage condition, t_{HZ} max is less than t_{LZ} min both for a given device and from device to device.
 3. Transition is measured $\pm 500\text{mV}$ from steady state voltage with specified loading in Load B.
 4. This parameter is sampled and not 100% tested.

● Read Cycle-1 (Notes 1, 2)

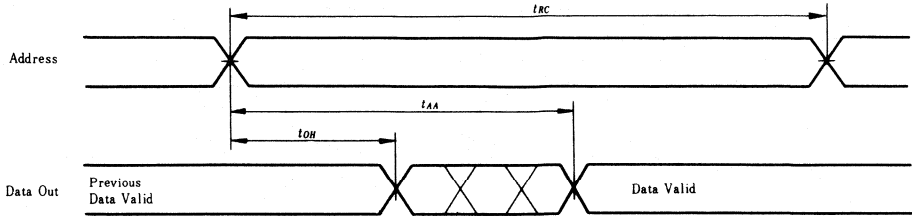

● Read Cycle-2 (Notes 1, 3)

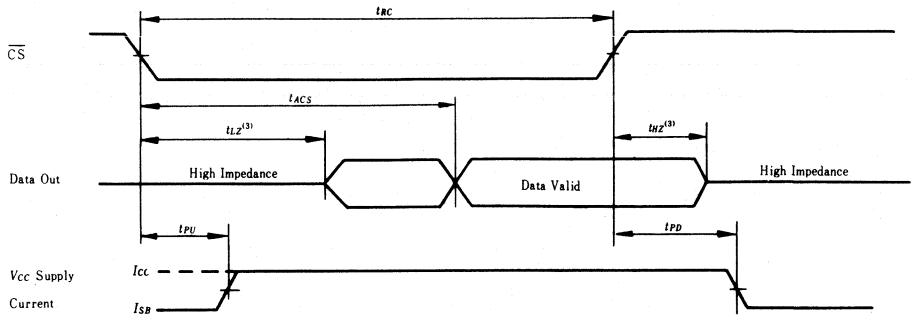

- Notes) 1. \overline{WE} is high for Read Cycle.
 2. Address valid prior to or coincident with \overline{CS} transition low.
 3. Transition is measured $\pm 500\text{mV}$ from steady state voltage with specified loading in Load B.

● WRITE CYCLE

Item	Symbol	HM6167HCG-45		HM6167HCG-55		Unit	Notes
		min	max	min	max		
Write Cycle Time	t_{WC}	45	—	55	—	ns	2
Chip Selection to End of Write	t_{CW}	40	—	50	—	ns	
Address Valid to End of Write	t_{AW}	40	—	50	—	ns	
Address Setup Time	t_{AS}	0	—	0	—	ns	
Write Pulse Width	t_{WP}	25	—	35	—	ns	
Write Recovery Time	t_{WR}	0	—	0	—	ns	
Data Valid to End of Write	t_{DW}	25	—	25	—	ns	
Data Hold Time	t_{DH}	0	—	0	—	ns	
Write Enable to Output in High Z	t_{WZ}	0	25	0	25	ns	3, 4
Output Active from End of Write	t_{OW}	0	—	0	—	ns	3, 4

- Notes) 1. If \overline{CS} goes high simultaneously with \overline{WE} high, the output remains in a high impedance state.
 2. All Write Cycle timings are referenced from the last valid address to the first transitioning address.
 3. Transition is measured $\pm 500\text{mV}$ from steady state voltage with specified loading in Load B.
 4. This parameter is sampled and not 100% tested.

● Write Cycle-1 (\overline{WE} Controlled)

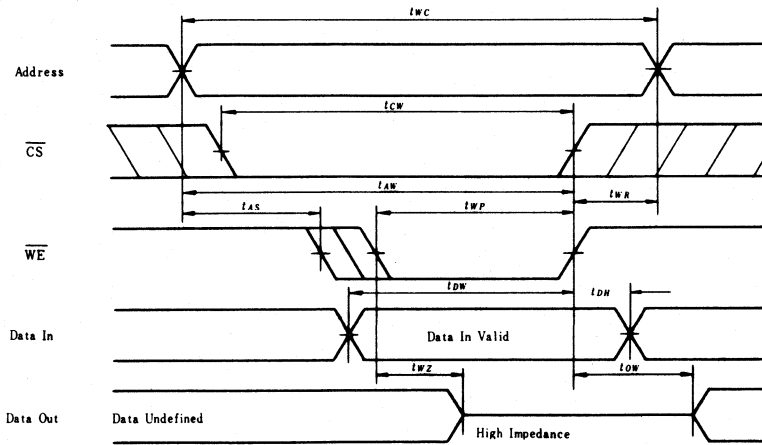

● Write Cycle-2 (\overline{CS} Controlled)

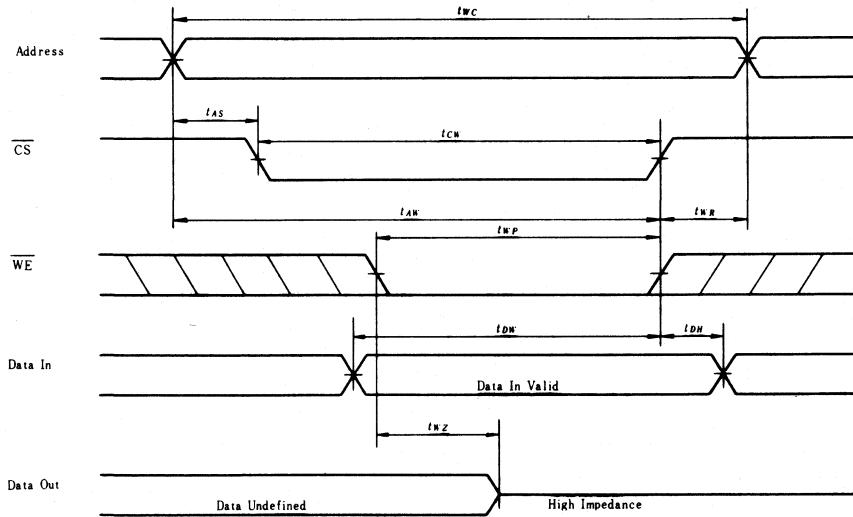

HM6167HLP-45, HM6167HLP-55

16384-word x 1-bit High Speed Static CMOS RAM

■ FEATURES

- Fast Access Time. HM6167HLP-45 45ns (max)
HM6167HLP-55 55ns (max)
- Low Power Standby and Low Power Operation
Standby 5μW (typ) and Operating 200mW (typ)
- Capable of Battery Back-up Operation
- Single +5V Supply and High Density 20 Pin Package
- Completely static Memory
No Clock or Timing Strobe Required
- Equal Access and Cycle Times
- Directly TTL Compatible All Inputs and Output

■ BLOCK DIAGRAM

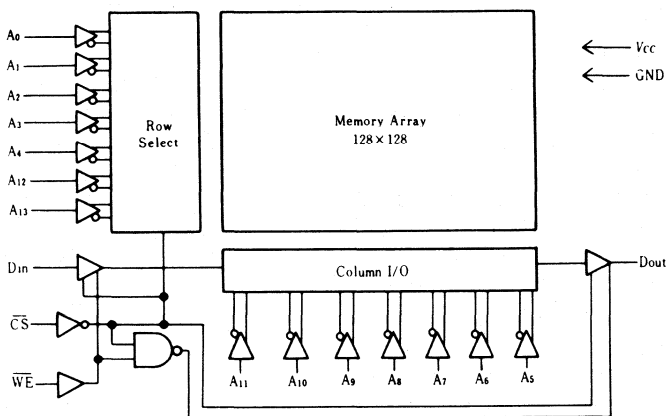

■ ABSOLUTE MAXIMUM RATINGS

Item	Symbol	Rating	Unit
Terminal Voltage with respect to GND	V_T	-3.5* to +7.0	V
Power Dissipation	P_T	1.0	W
Operating Temperature	T_{opr}	0 to +70	°C
Storage Temperature	T_{stg}	-55 to +125	°C
Storage Temperature Under Bias	T_{bias}	-10 to +85	°C

* Pulse Width 20ns, DC: -0.5V

■ RECOMMENDED DC OPERATING CONDITIONS ($T_a = 0$ to +70°C)

Item	Symbol	min	typ	max	Unit
Supply Voltage	V_{CC}	4.5	5.0	5.5	V
	GND	0	0	0	V
Input Voltage	V_{IH}	2.2	-	6.0	V
	V_{IL}	-3.0*	-	0.8	V

* Pulse Width 20ns, DC: V_{IL} min = -0.5V

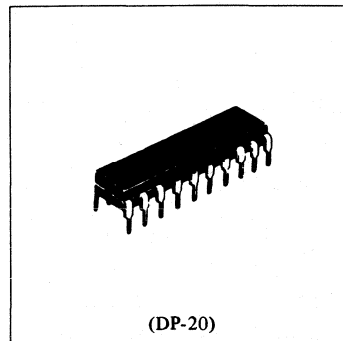

■ PIN ARRANGEMENT

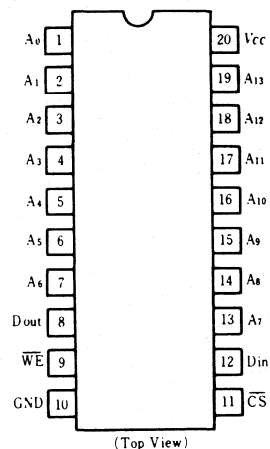

■ TRUTH TABLE

\overline{CS}	\overline{WE}	Mode	V_{CC} Current	Dout Pin	Ref. Cycle
H	×	Not selected	I_{SB}, I_{SB1}	High-Z	
L	H	Read	I_{CC}	Dout	Read Cycle
L	L	Write	I_{CC}	High-Z	Write Cycle

■ DC AND OPERATING CHARACTERISTICS ($V_{CC}=5V \pm 10\%$, $T_a=0 \sim +70^\circ C$)

Item	Symbol	Test Conditions	min	typ	max	Unit
Input Leakage Current	$ I_{LI} $	$V_{CC}=5.5V$ $V_{IN}=0V \sim V_{CC}$	—	—	2	μA
Output Leakage Current	$ I_{LO} $	$\overline{CS}=V_{IH}$, $V_{OI}=0V \sim V_{CC}$	—	—	2	μA
Operating Power Supply Current	I_{CC}	$\overline{CS}=V_{IL}$, Output Open	—	40	80	mA
Standby Power Supply Current	I_{SB}	$\overline{CS}=V_{IH}$	—	10	20	mA
	I_{SB1}	$\overline{CS}=V_{CC}-0.2V$ $V_{IN} \leq 0.2V$ or $\geq V_{CC}-0.2V$	—	1	50	μA
Output Low Voltage	V_{OL}	$I_{OL}=8mA$	—	—	0.4	V
Output High Voltage	V_{OH}	$I_{OH}=-4mA$	2.4	—	—	V

Note) Typical limits are at $V_{CC}=5.0V$, $T_a=25^\circ C$ and specified loading.

■ AC TEST CONDITIONS

Input pulse levels: GND to 3.0V
 Input rise and fall times: 5 ns
 Input timing reference levels: 1.5V
 Output reference levels: 1.5V
 Output load: See Figure

Output Load A

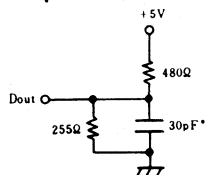

* Including scope and jig.

Output Load B

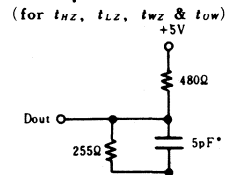

* Including scope and jig.

■ CAPACITANCE ($T_a=25^\circ C$, $f=1.0MHz$)

Item	Symbol	typ.	max	Unit	Conditions
Input Capacitance	C_{IN}	3	5	pF	$V_{IN}=0V$
Output Capacitance	C_{OUT}	5	7	pF	$V_{OUT}=0V$

Note) This parameter is sampled and not 100% tested.

■ AC CHARACTERISTICS ($T_a=0^\circ C$ to $+70^\circ C$, $V_{CC}=5V \pm 10\%$, unless otherwise noted.)

● READ CYCLE

Item	Symbol	HM6167HLP-45		HM6167HLP-55		Unit	Notes
		min	max	min	max		
Read Cycle Time	t_{RC}	45	—	55	—	ns	(1)
Address Access Time	t_{AA}	—	45	—	55	ns	
Chip Select Access Time	t_{ACS}	—	45	—	55	ns	
Output Hold from Address Change	t_{OH}	5	—	5	—	ns	
Chip Selection to Output in Low Z	t_{LZ}	5	—	5	—	ns	(2) (3) (7)
Chip Selection to Output in High Z	t_{HZ}	0	30	0	30	ns	(2) (3) (7)
Chip Selection to Power Up Time	t_{PU}	0	—	0	—	ns	
Chip Deselection to Power Down Time	t_{PD}	—	30	—	30	ns	

- NOTES:
- All Read Cycle timing are referenced from last valid address to the first transitioning address.
 - At any given temperature and voltage condition, t_{HZ} max. is less than t_{LZ} min. both for a given device and from device to device.
 - Transition is measured $\pm 500mV$ from steady state voltage with specified loading in Load B.
 - \overline{WE} is High for READ cycle.
 - Device is continuously selected, $\overline{CS} = V_{IL}$.
 - Addresses valid prior to or coincident with \overline{CS} transition low.
 - This parameter is sampled and not 100% tested.

● TIMING WAVEFORM OF READ CYCLE NO. 1 ^{4) 5)}

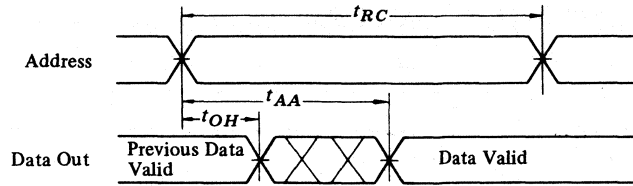

● TIMING WAVEFORM OF READ CYCLE NO. 2 ^{4) 6)}

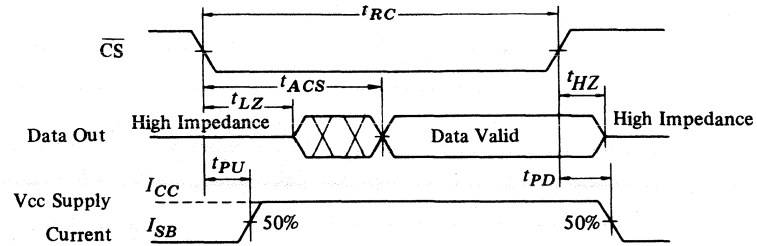

● WRITE CYCLE

Item	Symbol	HM6167HLP-45		HM6167HLP-55		Unit	Notes
		min	max	min	max		
Write Cycle Time	t_{WC}	45	-	55	-	ns	(2)
Chip Selection to End of Write	t_{CW}	40	-	50	-	ns	
Address Valid to End of Write	t_{AW}	40	-	50	-	ns	
Address Setup Time	t_{AS}	0	-	0	-	ns	
Write Pulse Width	t_{WP}	25	-	35	-	ns	
Write Recovery Time	t_{WR}	0	-	0	-	ns	
Data Valid to End of Write	t_{DW}	25	-	25	-	ns	
Data Hold Time	t_{DH}	0	-	0	-	ns	
Write Enable to Output in High Z	t_{WZ}	0	25	0	25	ns	(3) (4)
Output Active from End of Write	t_{OW}	0	-	0	-	ns	(3) (4)

- NOTES: 1. If \overline{CS} goes high simultaneously with \overline{WE} high, the output remains in a high impedance states.
 2. All Write Cycle timings are referenced from the last valid address to the first transitions address.
 3. Transition is measured $\pm 500\text{mV}$ from steady state voltage with specified loading in Load B.
 4. This parameter is sampled and not 100% tested.

● TIMING WAVEFORM OF WRITE CYCLE NO. 1 (\overline{WE} Controlled)

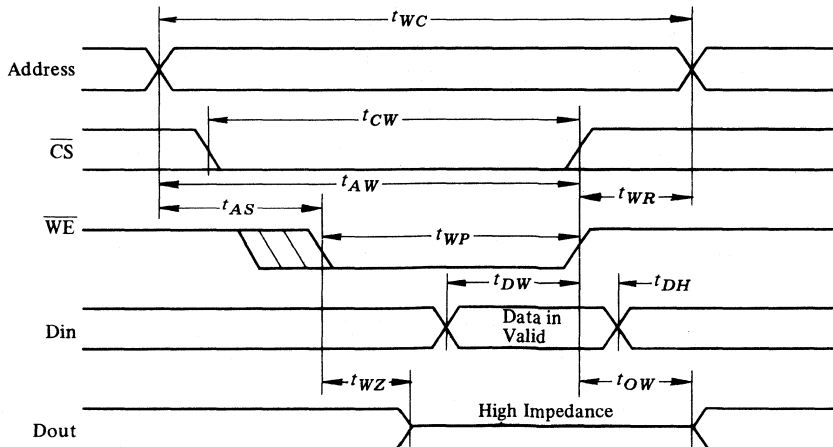

●TIMING WAVEFORM OF WRITE CYCLE NO. 2 ($\overline{\text{CS}}$ Controlled)

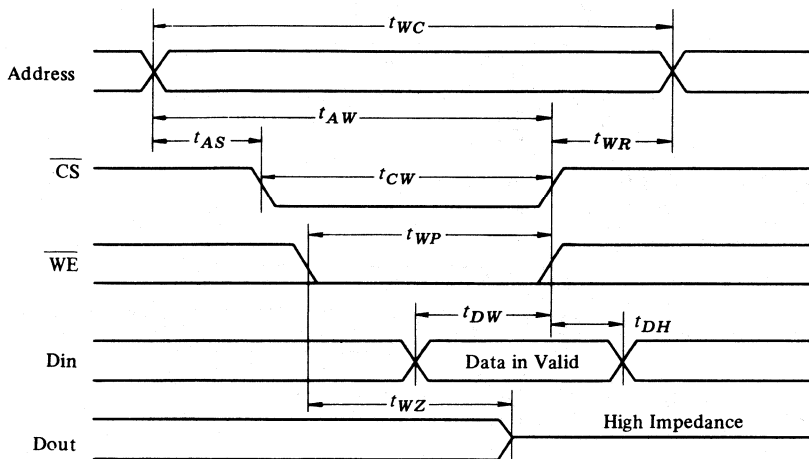

■LOW V_{CC} DATA RETENTION CHARACTERISTICS ($T_a=0^{\circ}\text{C}$ to 70°C)

Parameter	Symbol	Test Condition	min	typ	max	Unit
V_{CC} for Data Retention	V_{DR}		2.0	—	—	V
Data Retention Current	I_{CCDR}	$\overline{\text{CS}} \geq V_{CC} - 0.2\text{V}$ $V_{in} \geq V_{CC} - 0.2\text{V}$ or	—	—	20*	μA
		$0\text{V} \leq V_{in} \leq 0.2\text{V}$	—	—	30**	
Chip Deselect to Data Retention Time	t_{CDR}	$0\text{V} \leq V_{in} \leq 0.2\text{V}$	0	—	—	ns
Operation Recovery Time	t_R		t_{RC}^{Δ}	—	—	ns

Δt_{RC} - Read Cycle Time

* $V_{CC} = 2.0\text{V}$
** $V_{CC} = 3.0\text{V}$

●LOW V_{CC} DATA RETENTION WAVEFORM

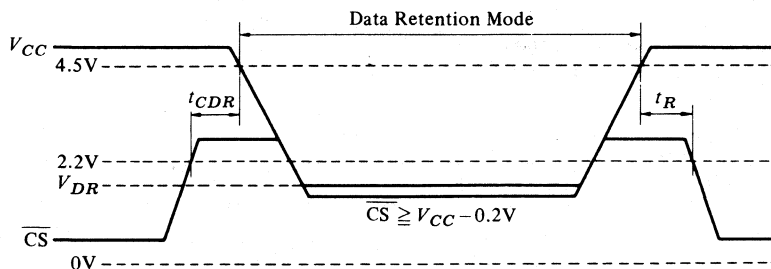

HM6264P-10, HM6264P-12, HM6264P-15

8192-word x 8-bit High Speed Static CMOS RAM

■ FEATURES

- Fast access Time 100ns/120ns/150ns (max.)
- Low Power Standby Standby: 0.1mW (typ.)
- Low Power Operation Operating: 200mW (typ.)
- Single +5V Supply
- Completely Static Memory. . . . No clock or Timing Strobe Required
- Equal Access and Cycle Time
- Common Data Input and Output, Three State Output
- Directly TTL Compatible: All Input and Output
- Standard 28pin Package Configuration
- Pin Out Compatible with 64K EPROM HN482764

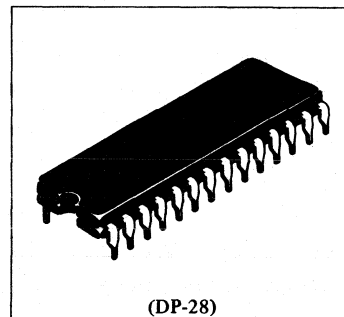

(DP-28)

■ BLOCK DIAGRAM

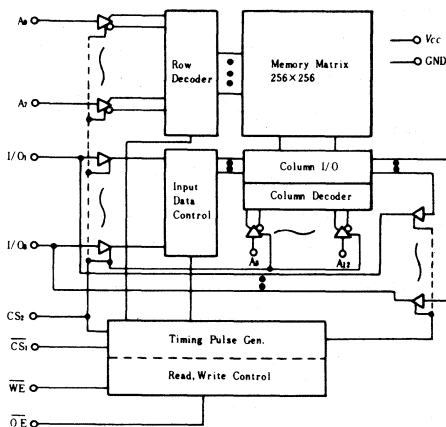

■ ABSOLUTE MAXIMUM RATINGS

Item	Symbol	Rating	Unit
Terminal Voltage *	V_T	-0.5 ** to +7.0	V
Power Dissipation	P_T	1.0	W
Operating Temperature	T_{opr}	0 to +70	°C
Storage Temperature	T_{stg}	-55 to +125	°C
Storage Temperature (Under Bias)	T_{bias}	-10 to +85	°C

* With respect to GND. ** Pulse width 50ns: -3.0V

■ PIN ARRANGEMENT

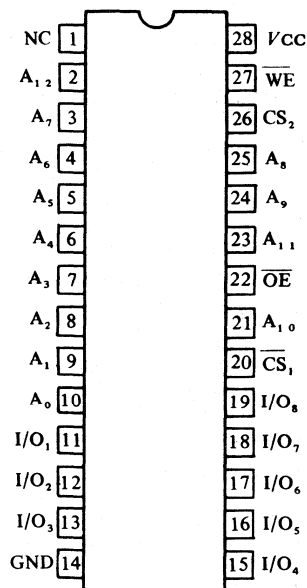

(Top View)

■ TRUTH TABLE

WE	CS ₁	CS ₂	OE	Mode	I/O Pin	V _{CC} Current	Note
X	H	X	X	Not Selected (Power Down)	High Z	I _{SB} , I _{SB1}	
X	X	L	X		High Z	I _{SB} , I _{SB2}	
H	L	H	H	Output Disabled	High Z	I _{CC} , I _{CC1}	
H	L	H	L	Read	Dout	I _{CC} , I _{CC1}	
L	L	H	H	Write	Din	I _{CC} , I _{CC1}	Write Cycle (1)
L	L	H	L		Din	I _{CC} , I _{CC1}	Write Cycle (2)

× : Don't care.

■ RECOMMENDED DC OPERATING CONDITIONS ($T_a = 0$ to $+70^\circ\text{C}$)

Item	Symbol	min	typ	max	Unit
Supply Voltage	V_{CC}	4.5	5.0	5.5	V
	GND	0	0	0	V
Input Voltage	V_{IH}	2.2	-	6.0	V
	V_{IL}	-0.3*	-	0.8	V

* Pulse Width 50ns: -3.0V

■ DC AND OPERATING CHARACTERISTICS ($V_{CC} = 5V \pm 10\%$, GND = 0V, $T_a = 0$ to $+70^\circ\text{C}$)

Item	Symbol	Test Condition	min	typ*	max	Unit
Input Leakage Current	$ I_{LI} $	$V_{in} = \text{GND to } V_{CC}$	-	-	2	μA
Output Leakage Current	$ I_{LO} $	$\overline{\text{CS}}1 = V_{IH}$ or $\text{CS}2 = V_{IL}$ or $\overline{\text{OE}} = V_{IH}$, $V_{I/O} = \text{GND to } V_{CC}$	-	-	2	μA
Operating Power Supply Current	I_{CC}	$\overline{\text{CS}}1 = V_{IL}$, $\text{CS}2 = V_{IH}$, $I_{I/O} = 0\text{mA}$	-	40	80	mA
Average Operating Current	I_{CC1}	Min. cycle, duty=100%, $\overline{\text{CS}}1 = V_{IL}$, $\text{CS}2 = V_{IH}$	-	60	110	mA
Standby Power Supply Current	I_{SB}	$\overline{\text{CS}}1 = V_{IH}$ or $\text{CS}2 = V_{IL}$, $I_{I/O} = 0\text{mA}$	-	1	3	mA
	I_{SB1}^{**}	$\overline{\text{CS}}1 \geq V_{CC} - 0.2\text{V}$, $\text{CS}2 \geq V_{CC} - 0.2\text{V}$ or $\text{CS}2 \leq 0.2\text{V}$	-	0.02	2	mA
	I_{SB2}^{**}	$\text{CS}2 \leq 0.2\text{V}$	-	0.02	2	mA
Output Voltage	V_{OL}	$I_{OL} = 2.1\text{mA}$	-	-	0.4	V
	V_{OH}	$I_{OH} = -1.0\text{mA}$	2.4	-	-	V

* Typical limits are at $V_{CC} = 5.0\text{V}$, $T_a = 25^\circ\text{C}$ and specified loading.

** V_{IL} min = -0.3V

■ CAPACITANCE ($f = 1\text{MHz}$, $T_a = 25^\circ\text{C}$)

Item	Symbol	Test Condition	typ	max	Unit
Input Capacitance	C_{in}	$V_{in} = 0\text{V}$	-	6	pF
Input/Output Capacitance	$C_{I/O}$	$V_{I/O} = 0\text{V}$	-	8	pF

Note) This parameter is sampled and not 100% tested.

■ AC CHARACTERISTICS ($V_{CC} = 5V \pm 10\%$, $T_a = 0$ to $+70^\circ\text{C}$)

● AC TEST CONDITIONS

Input Pulse Levels: 0.8 to 2.4V

Input Rise and Fall Times: 10ns

Input and Output Timing Reference Level: 1.5V

Output Load: 1TTL Gate and $C_L = 100\text{pF}$ (including scope and jig)

● READ CYCLE

Item	Symbol	HM6264P-10		HM6264P-12		HM6264P-15		Unit	
		min	max	min	max	min	max		
Read Cycle Time	t_{RC}	100	-	120	-	150	-	ns	
Address Access Time	t_{AA}	-	100	-	120	-	150	ns	
Chip Selection to Output	$\overline{\text{CS}}1$	t_{CO1}	-	100	-	120	-	150	ns
	$\text{CS}2$	t_{CO2}	-	100	-	120	-	150	ns
Output Enable to Output Valid	t_{OE}	-	50	-	60	-	70	ns	
Chip Selection to Output in Low Z	$\overline{\text{CS}}1$	t_{LZ1}	10	-	10	-	15	-	ns
	$\text{CS}2$	t_{LZ2}	10	-	10	-	15	-	ns
Output Enable to Output in Low Z	t_{OLZ}	5	-	5	-	5	-	ns	
Chip Deselection to Output in High Z	$\overline{\text{CS}}1$	t_{HZ1}	0	35	0	40	0	50	ns
	$\text{CS}2$	t_{HZ2}	0	35	0	40	0	50	ns
Output Disable to Output in High Z	t_{OHZ}	0	35	0	40	0	50	ns	
Output Hold from Address Change	t_{OH}	10	-	10	-	15	-	ns	

NOTES: 1 t_{HZ} and t_{OHZ} are defined as the time at which the outputs achieve the open circuit condition and are not referred to output voltage levels.

2 At any given temperature and voltage condition, t_{HZ} max is less than t_{LZ} min both for a given device and from device to device.

• READ CYCLE

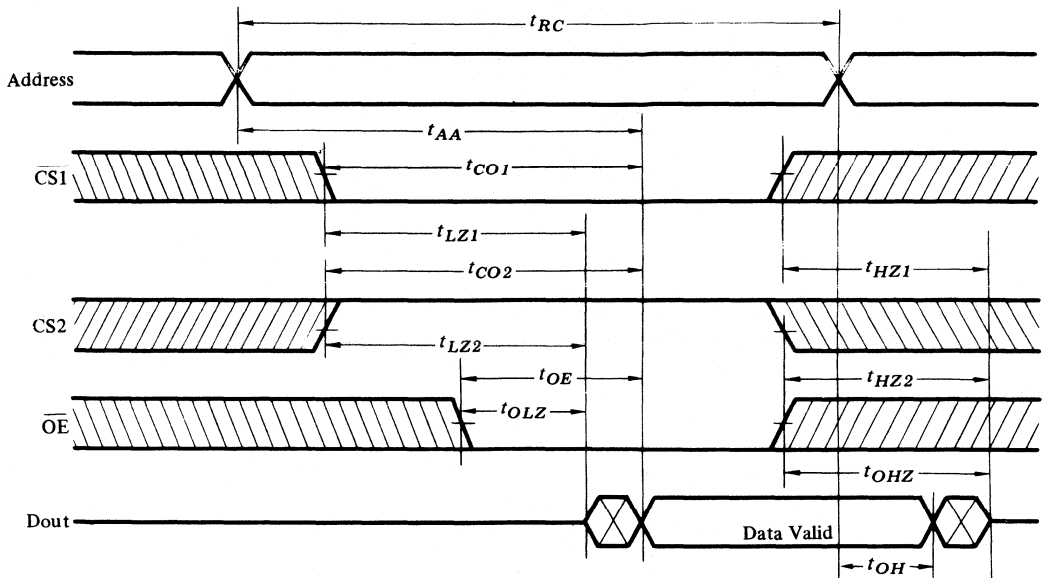

NOTE: 1) \overline{WE} is high for Read Cycle

• WRITE CYCLE

Item	Symbol	HM6264P-10		HM6264P-12		HM6264P-15		Unit	
		min	max	min	max	min	max		
Write Cycle Time	t_{WC}	100	—	120	—	150	—	ns	
Chip Selection to End of Write	t_{CW}	80	—	85	—	100	—	ns	
Address Setup Time	t_{AS}	0	—	0	—	0	—	ns	
Address Valid to End of Write	t_{AW}	80	—	85	—	100	—	ns	
Write Pulse Width	t_{WP}	60	—	70	—	90	—	ns	
Write Recovery Time	CS1, WE	t_{WR1}	5	—	5	—	10	—	ns
	CS2	t_{WR2}	15	—	15	—	15	—	ns
Write to Output in High Z	t_{WHZ}	0	35	0	40	0	50	ns	
Data to Write Time Overlap	t_{DW}	40	—	50	—	60	—	ns	
Data Hold from Write Time	t_{DH}	0	—	0	—	0	—	ns	
\overline{OE} to Output in High Z	t_{OHZ}	0	35	0	40	0	50	ns	
Output Active from End of Write	t_{OW}	5	—	5	—	10	—	ns	

• WRITE CYCLE (1) ($\overline{\text{OE}}$ clock)

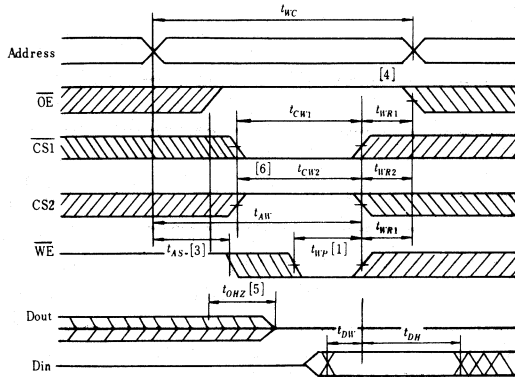

• WRITE CYCLE (2) ($\overline{\text{OE}}$ Low Fix)

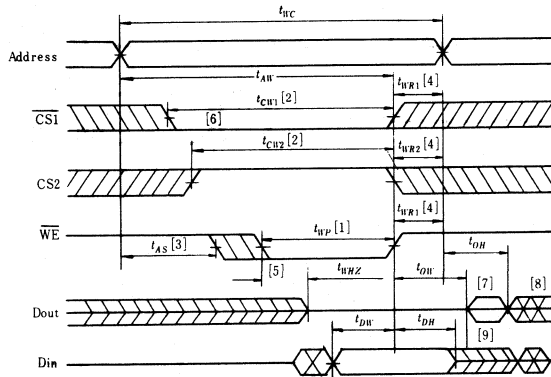

- NOTES: 1) A write occurs during the overlap of a low $\overline{\text{CS1}}$, a high $\overline{\text{CS2}}$ and a low $\overline{\text{WE}}$. A write begins at the latest transition among $\overline{\text{CS1}}$ going low, $\overline{\text{CS2}}$ going high and $\overline{\text{WE}}$ going low. A write ends at the earliest transition among $\overline{\text{CS1}}$ going high, $\overline{\text{CS2}}$ going low and $\overline{\text{WE}}$ going high. t_{WP} is measured from the beginning of write to the end of write.
- 2) t_{CW} is measured from the later of $\overline{\text{CS1}}$ going low or $\overline{\text{CS2}}$ going high to the end of write.
- 3) t_{AS} is measured from the address valid to the beginning of write.
- 4) t_{WR} is measured from the end of write to the address change.
 t_{WR1} applies in case a write ends at $\overline{\text{CS1}}$ or $\overline{\text{WE}}$ going high.
 t_{WR2} applies in case a write ends at $\overline{\text{CS2}}$ going low.
- 5) During this period, I/O pins are in the output state, therefore the input signals of opposite phase to the outputs must not be applied.
- 6) If $\overline{\text{CS1}}$ goes low simultaneously with $\overline{\text{WE}}$ going low or after $\overline{\text{WE}}$ going low, the outputs remain in high impedance state.
- 7) t_{DN} is in the same phase of written data of this cycle.
- 8) t_{DN} is the read data of the new address.
- 9) If $\overline{\text{CS1}}$ is low and $\overline{\text{CS2}}$ is high during this period, I/O pins are in the output state. Therefore, the input signals of opposite phase to the outputs must not be applied to them.

HM6264LP-10, HM6264LP-12 HM6264LP-15

8192-word x 8-bit High Speed Static CMOS RAM

■ FEATURES

- Fast access Time 100ns/120ns/150ns (max.)
- Low Power Standby Standby: 0.01mW (typ.)
- Low Power Operation Operating: 200mW (typ.)
- Capability of Battery Back-up Operation
- Single +5V Supply
- Completely Static Memory. . . . No clock or Timing Strobe Required
- Equal Access and Cycle Time
- Common Data Input and Output, Three State Output
- Directly TTL Compatible: All Input and Output
- Standard 28pin Package Configuration
- Pin Out Compatible with 64K EPROM HN482764

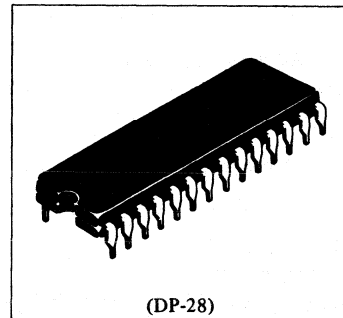

■ BLOCK DIAGRAM

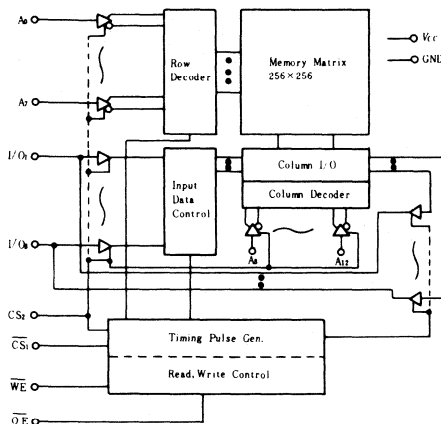

■ ABSOLUTE MAXIMUM RATINGS

Item	Symbol	Rating	Unit
Terminal Voltage *	V_T	-0.5 ** to +7.0	V
Power Dissipation	P_T	1.0	W
Operating Temperature	T_{opr}	0 to +70	°C
Storage Temperature	T_{stg}	-55 to +125	°C
Storage Temperature (Under Bias)	T_{bias}	-10 to +85	°C

* With respect to GND. ** Pulse width 50ns: -3.0V

■ TRUTH TABLE

WE	CS ₁	CS ₂	OE	Mode	I/O Pin	V _{CC} Current	Note
X	H	X	X	Not Selected (Power Down)	High Z	I_{SB}, I_{SB1}	
X'	X	L	X		High Z	I_{SB}, I_{SB2}	
H	L	H	H	Output Disabled	High Z	I_{CC}, I_{CC1}	
H	L	H	L	Read	Dout	I_{CC}, I_{CC1}	
L	L	H	H	Write	Din	I_{CC}, I_{CC1}	Write Cycle (1)
L	L	H	L		Din	I_{CC}, I_{CC1}	Write Cycle (2)

X : Don't care.

■ PIN ARRANGEMENT

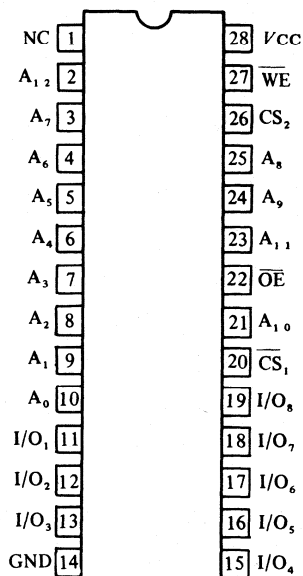

(Top View)

■ RECOMMENDED DC OPERATING CONDITIONS ($T_a = 0$ to $+70^\circ\text{C}$)

Item	Symbol	min	typ	max	Unit
Supply Voltage	V_{CC}	4.5	5.0	5.5	V
	GND	0	0	0	V
Input Voltage	V_{IH}	2.2	—	6.0	V
	V_{IL}	-0.3*	—	0.8	V

* Pulse Width 50ns: -3.0V

■ DC AND OPERATING CHARACTERISTICS ($V_{CC} = 5V \pm 10\%$, GND = 0V, $T_a = 0$ to $+70^\circ\text{C}$)

Item	Symbol	Test Condition	min	typ*	max	Unit
Input Leakage Current	$ I_{LI} $	$V_{in} = \text{GND to } V_{CC}$	—	—	2	μA
Output Leakage Current	$ I_{LO} $	$\overline{\text{CS}}1 = V_{IH}$ or $\text{CS}2 = V_{IL}$ or $\overline{\text{OE}} = V_{IH}$, $V_{I/O} = \text{GND to } V_{CC}$	—	—	2	μA
Operating Power Supply Current	I_{CC}	$\overline{\text{CS}}1 = V_{IL}$, $\text{CS}2 = V_{IH}$, $I_{I/O} = 0\text{mA}$	—	40	80	mA
Average Operating Current	I_{CC1}	Min. cycle, duty=100%, $\overline{\text{CS}}1 = V_{IL}$, $\text{CS}2 = V_{IH}$	—	60	110	mA
Standby Power Supply Current	I_{SB}	$\overline{\text{CS}}1 = V_{IH}$ or $\text{CS}2 = V_{IL}$, $I_{I/O} = 0\text{mA}$	—	1	3	mA
	I_{SB1}^{**}	$\overline{\text{CS}}1 \geq V_{CC} - 0.2\text{V}$, $\text{CS}2 \geq V_{CC} - 0.2\text{V}$ or $\text{CS}2 \leq 0.2\text{V}$	—	2	100	μA
	I_{SB2}^{**}	$\text{CS}2 \leq 0.2\text{V}$	—	2	100	μA
Output Voltage	V_{OL}	$I_{OL} = 2.1\text{mA}$	—	—	0.4	V
	V_{OH}	$I_{OH} = -1.0\text{mA}$	2.4	—	—	V

* Typical limits are at $V_{CC} = 5.0\text{V}$, $T_a = 25^\circ\text{C}$ and specified loading.

** V_{IL} min = -0.3V

■ CAPACITANCE ($f = 1\text{MHz}$, $T_a = 25^\circ\text{C}$)

Item	Symbol	Test Condition	typ	max	Unit
Input Capacitance	C_{in}	$V_{in} = 0\text{V}$	—	6	pF
Input/Output Capacitance	$C_{I/O}$	$V_{I/O} = 0\text{V}$	—	8	pF

Note) This parameter is sampled and not 100% tested.

■ AC CHARACTERISTICS ($V_{CC} = 5V \pm 10\%$, $T_a = 0$ to $+70^\circ\text{C}$)

● AC TEST CONDITIONS

Input Pulse Levels: 0.8 to 2.4V

Input Rise and Fall Times: 10ns

Input and Output Timing Reference Level: 1.5V

Output Load: 1TTL Gate and $C_L = 100\text{pF}$ (including scope and jig)

● READ CYCLE

Item	Symbol	HM6264LP-10		HM6264LP-12		HM6264LP-15		Unit	
		min	max	min	max	min	max		
Read Cycle Time	t_{RC}	100	—	120	—	150	—	ns	
Address Access Time	t_{AA}	—	100	—	120	—	150	ns	
Chip Selection to Output	$\overline{\text{CS}}1$	t_{CO1}	—	100	—	120	—	150	ns
	CS2	t_{CO2}	—	100	—	120	—	150	ns
Output Enable to Output Valid	t_{OE}	—	50	—	60	—	70	ns	
Chip Selection to Output in Low Z	$\overline{\text{CS}}1$	t_{LZ1}	10	—	10	—	15	—	ns
	CS2	t_{LZ2}	10	—	10	—	15	—	ns
Output Enable to Output in Low Z	t_{OLZ}	5	—	5	—	5	—	ns	
Chip Deselection to Output in High Z	$\overline{\text{CS}}1$	t_{HZ1}	0	35	0	40	0	50	ns
	CS2	t_{HZ2}	0	35	0	40	0	50	ns
Output Disable to Output in High Z	t_{OHZ}	0	35	0	40	0	50	ns	
Output Hold from Address Change	t_{OH}	10	—	10	—	15	—	ns	

NOTES: 1 t_{HZ} and t_{OHZ} are defined as the time at which the outputs achieve the open circuit condition and are not referred to output voltage levels.

2 At any given temperature and voltage condition, t_{HZ} max is less than t_{LZ} min both for a given device and from device to device.

• READ CYCLE

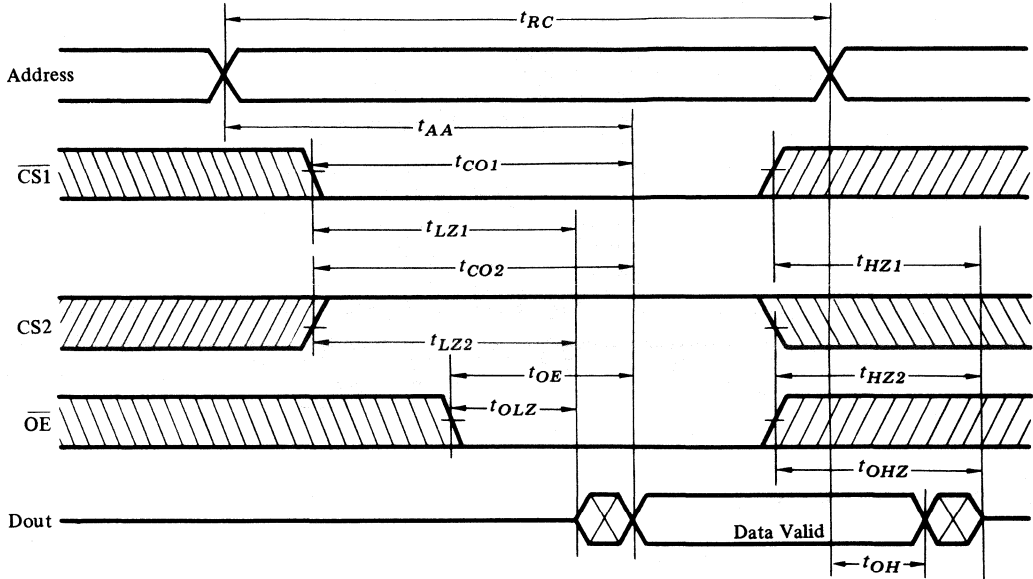

NOTE : 1) \overline{WE} is high for Read Cycle

• WRITE CYCLE

Item	Symbol	HM6264LP-10		HM6264LP-12		HM6264LP-15		Unit	
		min	max	min	max	min	max		
Write Cycle Time	t_{WC}	100	—	120	—	150	—	ns	
Chip Selection to End of Write	t_{CW}	80	—	85	—	100	—	ns	
Address Setup Time	t_{AS}	0	—	0	—	0	—	ns	
Address Valid to End of Write	t_{AW}	80	—	85	—	100	—	ns	
Write Pulse Width	t_{WP}	60	—	70	—	90	—	ns	
Write Recovery Time	$\overline{CS1}, \overline{WE}$	t_{WR1}	5	—	5	—	10	—	ns
	CS2	t_{WR2}	15	—	15	—	15	—	ns
Write to Output in High Z	t_{WHZ}	0	35	0	40	0	50	ns	
Data to Write Time Overlap	t_{DW}	40	—	50	—	60	—	ns	
Data Hold from Write Time	t_{DH}	0	—	0	—	0	—	ns	
\overline{OE} to Output in High Z	t_{OHZ}	0	35	0	40	0	50	ns	
Output Active from End of Write	t_{OW}	5	—	5	—	10	—	ns	

• WRITE CYCLE (1) (\overline{OE} clock)

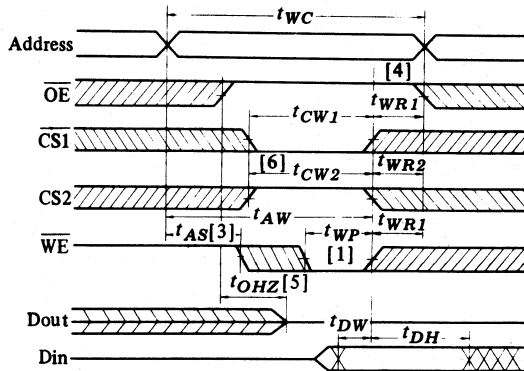

• WRITE CYCLE (2) (\overline{OE} Low Fix)

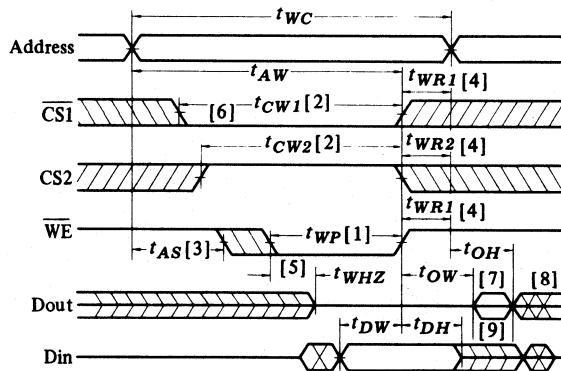

- NOTES:
- 1) A write occurs during the overlap of a low $\overline{CS1}$, a high $CS2$ and a low \overline{WE} . A write begins at the latest transition among $\overline{CS1}$ going low, $CS2$ going high and \overline{WE} going low. A write ends at the earliest transition among $\overline{CS1}$ going high, $CS2$ going low and \overline{WE} going high. t_{WP} is measured from the beginning of write to the end of write.
 - 2) t_{CW} is measured from the later of $\overline{CS1}$ going low or $CS2$ going high to the end of write.
 - 3) t_{AS} is measured from the address valid to the beginning of write.
 - 4) t_{WR} is measured from the end of write to the address change.
 t_{WR1} applies in case a write ends at $\overline{CS1}$ or \overline{WE} going high.
 t_{WR2} applies in case a write ends at $CS2$ going low.
 - 5) During this period, I/O pins are in the output state, therefore the input signals of opposite phase to the outputs must not be applied.
 - 6) If $\overline{CS1}$ goes low simultaneously with \overline{WE} going low or after \overline{WE} going low, the outputs remain in high impedance state.
 - 7) t_{DW} is in the same phase of written data of this cycle.
 - 8) t_{DH} is the read data of the new address.
 - 9) If $\overline{CS1}$ is low and $CS2$ is high during this period, I/O pins are in the output state. Therefore, the input signals of opposite phase to the outputs must not be applied to them.

■ **LOW V_{CC} DATA RETENTION CHARACTERISTICS ($T_a = 0$ to $+70$ °C)**

Item	Symbol	Test Condition	min	typ	max	Unit
V_{CC} for Data Retention	V_{DR1}	$\overline{CS1} \geq V_{CC} - 0.2V, CS2 \geq V_{CC} - 0.2V$ or $CS2 \leq 0.2V$	2.0	-	-	V
	V_{DR2}	$CS2 \leq 0.2V$	2.0	-	-	V
Data Retention Current	I_{CCDR1}	$V_{CC} = 3.0V, \overline{CS1} \geq V_{CC} - 0.2V, CS2 \geq V_{CC} - 0.2V$ or $CS2 \leq 0.2V$	-	1	50*	μA
	I_{CCDR2}	$V_{CC} = 3.0V, CS2 \leq 0.2V$	-	1	50*	μA
Chip Deselect to Data Retention Time	t_{CDR}	See Retention Waveform	0	-	-	ns
Operation Recovery Time	t_R		t_{RC}^{**}	-	-	ns

* V_{IL} min = -0.3V

** t_{RC} = Read Cycle Time

● **LOW V_{CC} DATA RETENTION WAVEFORM (1) ($\overline{CS1}$ Controlled)**

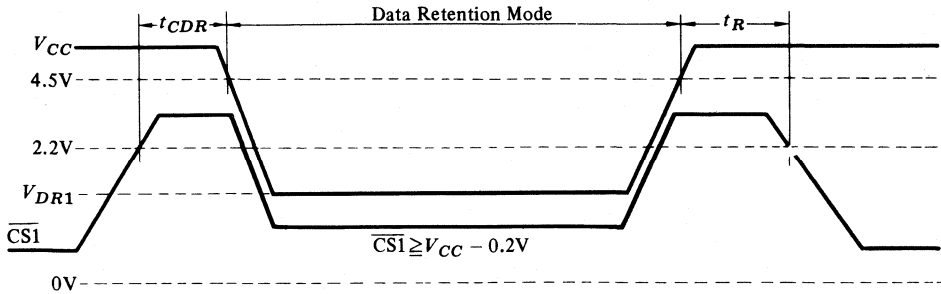

● **LOW V_{CC} DATA RETENTION WAVEFORM (2) ($CS2$ Controlled)**

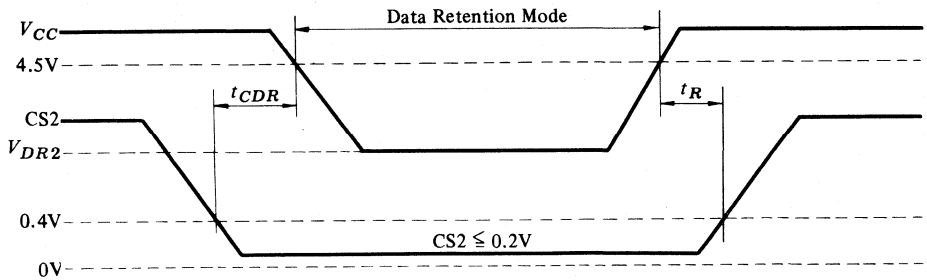

NOTE: CS_2 controls Address buffer, \overline{WE} buffer, $\overline{CS_1}$ buffer and Din buffer. If CS_2 controls data retention mode, V_{in} level (Address, \overline{WE} , $\overline{CS_1}$, I/O) can be in the high impedance state. If $\overline{CS_1}$ controls data retention mode, CS_2 must be $CS_2 \geq V_{CC} - 0.2V$ or $CS_2 \leq 0.2V$. The other inputs level (address, \overline{WE} , I/O) can be in the high impedance state.

MOS DYNAMIC RAM

HM4716A-1, HM4716A-2, HM4716A-3, HM4716A-4, HM4716AP-1, HM4716AP-2, HM4716AP-3, HM4716AP-4

16384-word × 1-bit Dynamic Random Access Memory

The HM4716A is a 16,384 word by 1 bit MOS random access memory circuit fabricated with HITACHI's double poly N-channel silicon gate process for high performance and high functional density. The HM4716A uses a single transistor dynamic storage cell and dynamic control circuitry to achieve high speed and low power dissipation. Multiplexed address inputs permit the HM4716A to be packaged in a standard 16 pin DIP on 0.3 inch centers. This package size provides high system bit densities and is compatible with widely available automated testing and insertion equipment. The HM4716A is designed to facilitate upgrading of the 16-pin 4K RAM. However, the data output latch incorporated in the present 4K design is not appropriate for 16K RAM's. This new generation of memory products (16K RAM's) requires a slightly modified output stage to allow more system flexibility. Instead of the conventional latch, the HM4716A output is controlled by the Column Address Strobe (\overline{CAS}). Data out of the HM4716A will remain valid from the access time from the Column Address Strobe until \overline{CE} goes into precharge logic 1). However, in early write cycles (\overline{W} active low before \overline{CE} goes low), the data output will remain in the high impedance (open-circuit) state throughout the entire cycle. This type of output operation results in some very significant system implications.

1. Common I/O Operation

If all write operation are handled in the "early write" mode, then data in can be connected directly to data-out on a printed circuit board.

2. Data Output Control

Data will remain valid at the output during a read cycle from TCELOV until \overline{CE} returns to precharge.

This allows data to be valid from one cycle up until a new memory cycle begins.

3. Two Methods of Chip Selection

Both \overline{CE} and/or \overline{RE} can be decoded for chip selection.

4. Refresh

Refreshing can be accomplished every 2 ms by either of the two following methods:

- (1) normal read or write cycles on 128 addresses, A0 to A6.
- (2) \overline{RE} only cycles on 128 addresses, A0 to A6.

A write cycle will refresh stored data on all bits of the selected row except the bit which is addressed.

\overline{RE} only refreshes results in a substantial reduction in operating power.

5. Page Mode Operation

The HM4716A is designed for page mode operation.

HM4716A-1, HM4716A-2,
HM4716A-3, HM4716A-4

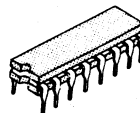

(DG-16A)

HM4716AP-1, HM4716AP-2,
HM4716AP-3, HM4716AP-4

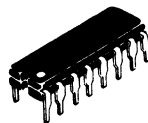

(DP-16)

■ PIN ARRANGEMENT

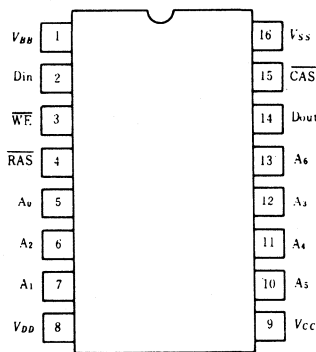

(Top View)

Old	New	Definitions
A ₀ -A ₆	A0-A6	Address Inputs
\overline{CAS}	\overline{CE}	Column Address Strobe
D _{IN}	D	Data In
D _{OUT}	Q	Data Out
\overline{RAS}	\overline{RE}	Row Address Strobe
\overline{WRITE}	W	Read/Write Input
V _{BB}	VBB	Power (-5V)
V _{CC}	VCC	Power (+5V)
V _{DD}	VDD	Power (+12V)
V _{SS}	VSS	Ground

■ FEATURES

- All Inputs Including Clocks TTL Compatible
- Input Latches for Address and Data in
- Three-State TTL Compatible Output
- Common I/O Capability
- Only 128 Refresh Cycles Required Every 2ms
- Standard Power Supplies +12V, +5V, -5V
(All with 10% tolerance)

- Maximum Access Time
 - HM4716A-1 120ns
 - HM4716A-2 150ns
 - HM4716A-3 200ns
 - HM4716A-4 250ns
- Read or Write Cycle Time
 - HM4716A-1 320ns
 - HM4716A-2 320ns
 - HM4716A-3 375ns
 - HM4716A-4 410ns

■ FUNCTIONAL BLOCK DIAGRAM

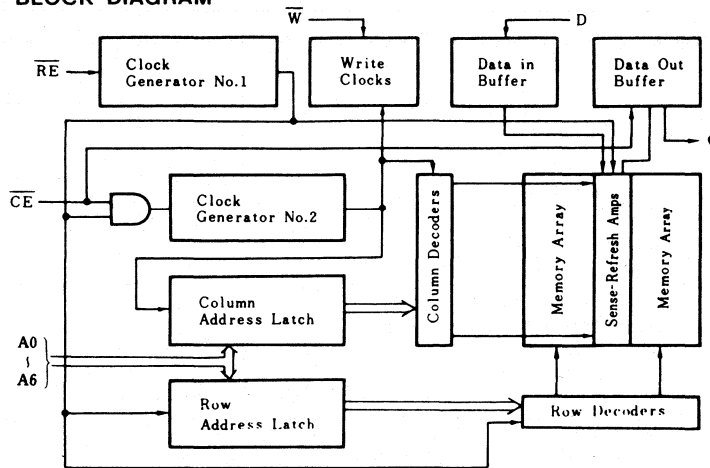

■ ABSOLUTE MAXIMUM RATINGS

- Voltage on any Pin Relative to VBB -0.5V to +20V
- Voltage on VDD, VCC Supplies Relative to VSS -0.5V to +15V
- Voltage on Q Pin Relative to VSS -0.5V to +10V
- Operating Temperature, TA (Ambient) 0°C to +70°C
- Storage Temperature (Ambient)* -65°C to +150°C
- Short-Circuit Output Current 50mA
- Power Dissipation 1W

* In case of HM4716AP Series are -55°C to +125°C.

■ RECOMMENDED DC OPERATING CONDITIONS (TA=0 to +70°C)

Parameter	Symbol	min.	typ.	max.	Unit	Notes
Supply Voltage	VDD	10.8	12.0	13.2	V	1
	VCC	4.5	5.0	5.5	V	
	VSS	0	0	0	V	
	VBB	-4.5	-5.0	-5.5	V	
Input High (logic 1) Voltage $\overline{RE}, CE, \overline{W}$	VIHC	2.7	—	6.5	V	1
Input High (logic 1) Voltage All inputs except $\overline{RE}, CE, \overline{W}$	VIH	2.4	—	6.5	V	1
Input Low (logic 0) Voltage all inputs	VIL	-1.0	—	0.8	V	1

■ DC ELECTRICAL CHARACTERISTICS

($T_a = 0$ to $+70^\circ\text{C}$, $V_{DD} = 12\text{V} \pm 10\%$, $V_{CC} = 5\text{V} \pm 10\%$, $V_{BB} = -5\text{V} \pm 10\%$, $V_{SS} = 0\text{V}$)

Parameter	Symbol	min	max	Unit	Notes
OPERATING CURRENT	I_{DD1}	—	35	mA	2
Average Power Supply Operating Current ($\overline{\text{RE}}, \overline{\text{CE}}$ Cycling; TRELREL=375ns)	I_{CC1}	—	—	mA	3
STANDBY CURRENT	I_{DD2}	—	1.5	mA	
Power Supply Standby Current ($\overline{\text{RE}} = \overline{\text{CE}} = V_{IHC}$)	I_{CC2}	-10	10	μA	5
REFRESH CURRENT	I_{DD3}	—	27	mA	2
Average Power Supply Current, Refresh Mode ($\overline{\text{RE}}$ Cycling, $\overline{\text{CE}} = V_{IHC}$; TRELREL=375ns)	I_{CC3}	-10	10	μA	5
PAGE MODE CURRENT	I_{DD4}	—	27	mA	
Average Power Supply Current, Page-mode Operation ($\overline{\text{RE}} = V_{IL}$, $\overline{\text{CE}}$ Cycling; TCELCEL=225ns)	I_{CC4}	—	—	mA	3
INPUT LEAKAGE					
Input Leakage Current, any Input ($V_{BB} = -5\text{V}$, $V_{IN} = 0$ to $+7\text{V}$, all other pins not under test = 0V)	I_{IL}	-10	10	μA	
OUTPUT LEAKAGE					
Output Leakage Current (Q is Disabled, $V_{OUT} = 0$ to $+5.5\text{V}$)	I_{OL}	-10	10	μA	5
OUTPUT LEVELS					
Output High (Logic 1) Voltage ($I_{OUT} = -5\text{mA}$)	V_{OH}	2.4	V_{CC}	V	4
Output Low (Logic 0) Voltage ($I_{OUT} = 4.2\text{mA}$)	V_{OL}	0	0.4	V	

NOTES

- All voltages referenced to VSS, VBB must be applied before and removed after other supply voltage.
- Current depend on cycle rate: maximum current is measured at the fastest cycle rate.
- ICC depends upon output loading. The VCC supply is connected to the output buffer only.
- Output voltage will swing from VSS to VCC when activated with no current loading. For purposes of maintaining data in standby mode, VCC may be reduced to VSS without affecting refresh operations or data retention. However, the VOH (min) specification is not guaranteed in this mode.
- ICC2, ICC3 and IOL consists of leakage current only.
- AC measurements assume TT = 5ns.
- VIHC (min) or VIH (min) and VIL (max) are reference levels for measuring timing of input signals. Also, transition times are measured between VIHC or VIH and VILS.
- Assumes that TRELCEL = TRELCEL (max.) If TRELCEL is greater than the maximum recommended value shown in this table, TRELQV exceeds the value shown.
- Assumes that TRELCEL = TRELCEL (max).
- Measured with a load circuit equivalent to 2TTL loads and 100pF (in case of HM4716A-2:1 TTL and 50pF). And VSS + 0.8V, VSS + 2.0V are the reference level for measuring timing of Q.
- TCEHQZ (max) defines the time at which the output achieves the open circuit condition and is not referenced to output voltage levels.
- Operation with the TRELCEL (max) limit insures that TRELQC (max) can be met TRELCEL (max) is specified as a reference point only; if TRELCEL is greater than the specified TRELCEL (max) limit, then access time is controlled exclusively by TCELQV.
- These parameters are reference to $\overline{\text{CE}}$ leading edge in early write cycles and to $\overline{\text{W}}$ leading edge in delayed write or read-modify-write cycles.
- TWLCEL, TCELWL and TRELWL are not restrictive operating parameters. They are included in the data sheet as electrical characteristics only: if TWLCEL = TWLCEL (min), the cycle is an early write and the data out pin will remain open circuit (high impedance) throughout the entire cycle; if TCELWL = TCELWL (min) and TRELWL will contain data read from the selected cell; if neither of the above sets of conditions is satisfied the condition of the data out (at access time) is indeterminate.
- Capacitance measured with Boonton Meter or effective capacitance measuring methods.)
- $\overline{\text{CE}} = \text{VIHC}$ to disable Q.

■ ELECTRICAL CHARACTERISTICS AND RECOMMENDED AC OPERATING CONDITIONS

($T_a = 0$ to $+70^\circ\text{C}$, $V_{DD} = 12\text{V} \pm 10\%$, $V_{CC} = 5\text{V} \pm 10\%$, $V_{SS} = 0\text{V}$, $V_{BB} = -5\text{V} \pm 10\%$)

Parameter	Symbol		HM4716A-1		HM4716A-2		HM4716A-3		HM4716A-4		Unit	Notes
	Old	New	min	max	min	max	min	max	min	max		
Random Read or Write Cycle Time	t_{RC}	TRELREL	320	—	320	—	375	—	410	—	ns	
Read-Write Cycle Time	t_{RWC}	TRELREL	320	—	320	—	375	—	515	—	ns	8
Page Mode Cycle Time	t_{PC}	TCELCEL	160	—	170	—	225	—	275	—	ns	
Access Time From $\overline{\text{RE}}$	t_{RAC}	TRELQV	—	120	—	150	—	200	—	250	ns	8, 10
Access Time From $\overline{\text{CE}}$	t_{CAC}	TCELQV	—	80	—	100	—	135	—	165	ns	9, 10
Output Buffer Turn-off Delay	t_{OFF}	TCEHQZ	0	35	0	50	0	60	0	70	ns	11
Transition Time (Rise and Fall)	t_T	TT	3	35	3	35	3	50	3	50	ns	7
$\overline{\text{RE}}$ Precharge Time	t_{RP}	TREHREL	100	—	100	—	120	—	150	—	ns	
$\overline{\text{RE}}$ Pulse Width	t_{RAS}	TRELREH	120	10000	150	10000	200	10000	250	10000	ns	
$\overline{\text{RE}}$ Hold Time	t_{RSH}	TCELREH	80	—	100	—	135	—	165	—	ns	
$\overline{\text{CE}}$ Pulse Width	t_{CAS}	TCELCEH	80	10000	100	10000	135	10000	165	10000	ns	
$\overline{\text{CE}}$ Hold Time	t_{CSH}	TRELCEH	120	—	150	—	200	—	250	—	ns	
$\overline{\text{RE}}$ to $\overline{\text{CE}}$ Delay Time	t_{RCD}	TRELCEL	15	40	25	50	30	65	40	85	ns	12
$\overline{\text{CE}}$ to $\overline{\text{RE}}$ Precharge Time	t_{CRP}	TCEHREL	0	—	-20	—	-20	—	-20	—	ns	
Row Address Set-up Time	t_{ASR}	TAVREL	0	—	0	—	0	—	0	—	ns	
Row Address Hold Time	t_{RAH}	TRELAX	15	—	20	—	25	—	35	—	ns	
Column Address Set-up Time	t_{ASC}	TAVCEL	-5	—	-5	—	-5	—	-5	—	ns	
Column Address Hold Time	t_{CAH}	TCELAX	40	—	45	—	55	—	75	—	ns	
Column Address Hold Time Reference to $\overline{\text{RE}}$	t_{AR}	TRELAX	80	—	95	—	120	—	160	—	ns	
Read Command Set-up Time	t_{RCS}	TWHCEL	0	—	0	—	0	—	0	—	ns	
Read Command Hold Time	t_{RCH}	TCEHWL	0	—	20	—	20	—	20	—	ns	
Write Command Hold Time	t_{WCH}	TCELWH	40	—	45	—	55	—	75	—	ns	
Write Command Hold Time Reference $\overline{\text{RE}}$	t_{WCR}	TRELWH	80	—	95	—	120	—	160	—	ns	
Write Command Pulse Width	t_{WP}	TWLWH	40	—	45	—	55	—	75	—	ns	
Write Command to $\overline{\text{RE}}$ Lead Time	t_{RWL}	TWLREH	50	—	60	—	80	—	100	—	ns	
Write Command to $\overline{\text{CE}}$ Lead Time	t_{CWL}	TWLCEH	50	—	60	—	80	—	100	—	ns	
Data-in Set-up Time	t_{DS}	TDVCEL	0	—	0	—	0	—	0	—	ns	13
Data-in Hold Time	t_{DH}	TCELDX	40	—	45	—	55	—	75	—	ns	13
Data-in Hold Time Referenced $\overline{\text{RE}}$	t_{DHR}	TRELDX	80	—	95	—	120	—	160	—	ns	
$\overline{\text{CE}}$ Precharge Time (for Page-mode Cycle Only)	t_{CP}	TCEHCEL	60	—	60	—	80	—	100	—	ns	
Refresh Period	t_{REF}	TRVRV	—	2	—	2	—	2	—	2	ms	
$\overline{\text{W}}$ Command Set-up Time	t_{WCS}	TWLCEL	0	—	-20	—	-20	—	-20	—	ns	14
$\overline{\text{CE}}$ to $\overline{\text{RE}}$ Delay	t_{CWD}	TCELWL	60	—	70	—	95	—	125	—	ns	14
$\overline{\text{RE}}$ to $\overline{\text{W}}$ Delay	t_{RWD}	TRELWL	100	—	120	—	160	—	200	—	ns	14
$\overline{\text{RE}}$ Precharge to $\overline{\text{CE}}$ Hold Time	t_{RPC}	TREHCEL	0	—	0	—	0	—	0	—	ns	

■ AC ELECTRICAL CHARACTERISTICS

Parameter	Symbol	typ	max	Unit	Notes
Input Capacitance (A_0 - A_6 , D)	C_{I1}	—	5	pF	15
Input Capacitance $\overline{\text{RE}}$, $\overline{\text{CE}}$, $\overline{\text{W}}$	C_{I2}	—	10	pF	15
Output Capacitance (Q)	C_O	—	7	pF	15, 16

● PAGE MODE READ CYCLE

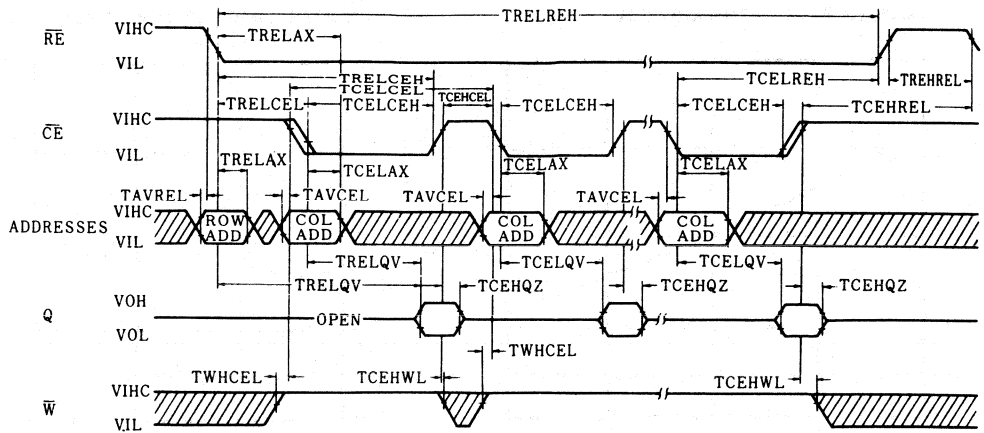

● PAGE MODE WRITE CYCLE

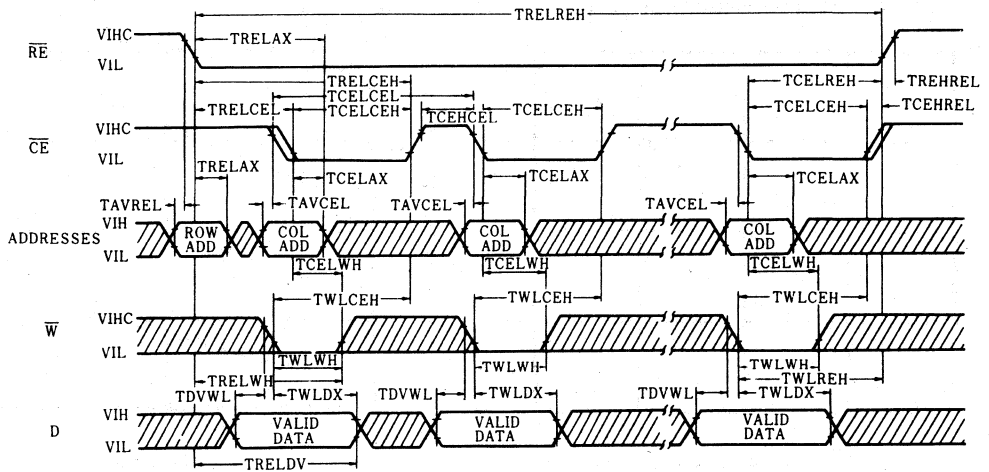

■ TYPICAL CHARACTERISTICS

ACCESS TIME (NORMARIZED) vs. V_{DD}

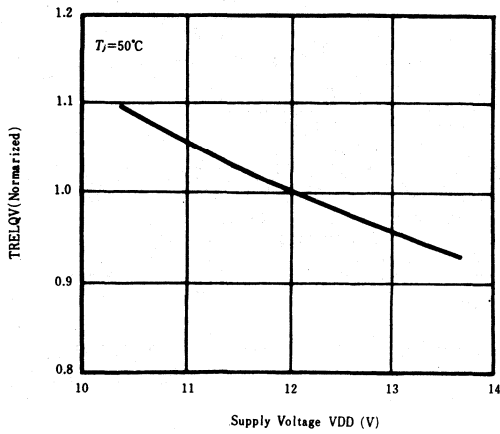

ACCESS TIME (NORMARIZED) vs. V_{BB}

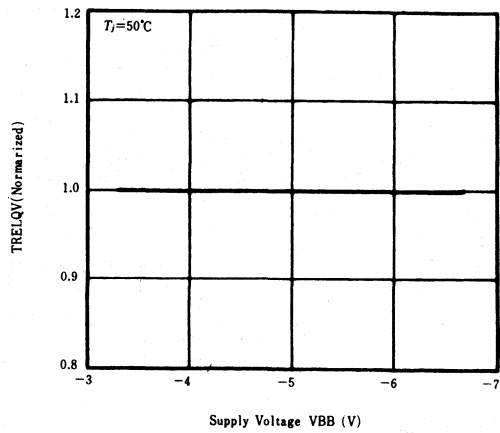

ACCESS TIME (NORMARIZED) vs. T_j

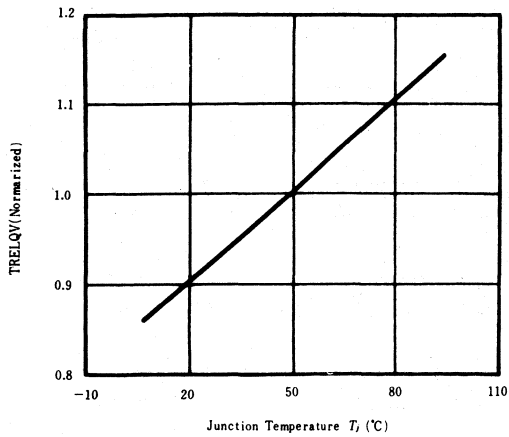

IDD1 vs. V_{DD}

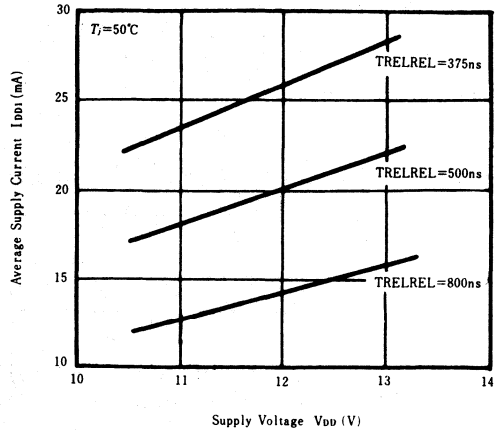

IDD1 vs. T_j

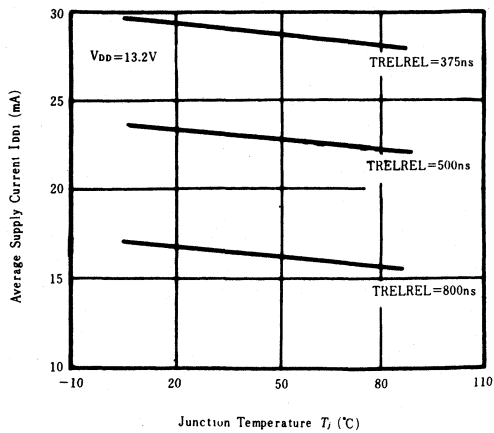

IDD1 vs. CYCLE RATE

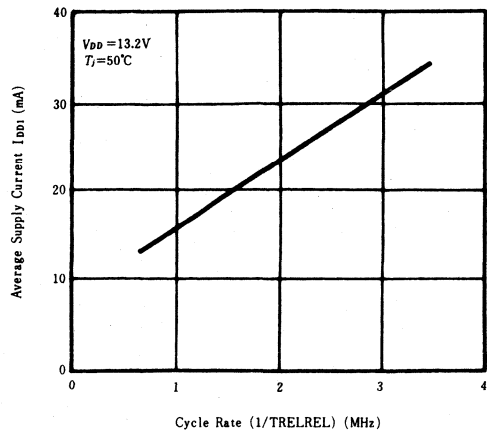

IDD2 (STANDBY) vs. V_{DD}

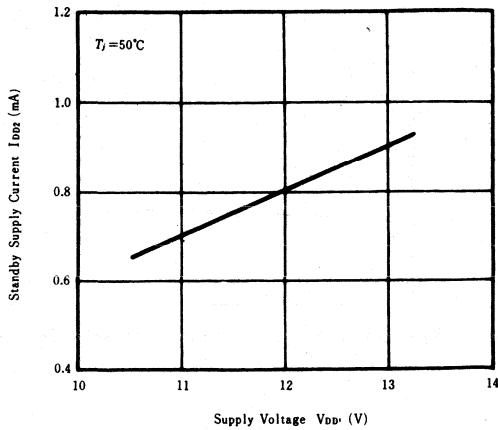

IDD2 (STANDBY) vs. T_j

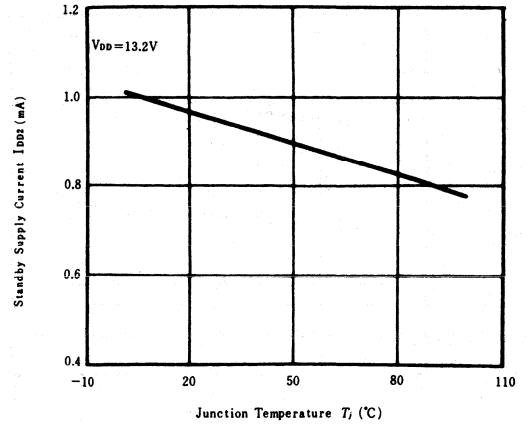

IDD3 ($\overline{\text{RE}}$ ONLY CYCLE) vs. V_{DD}

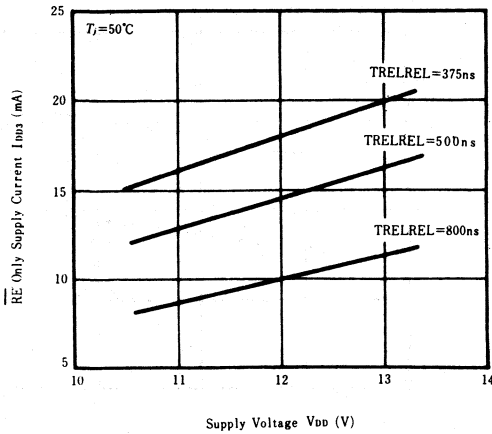

IDD3 ($\overline{\text{RE}}$ ONLY CYCLE) vs. T_j

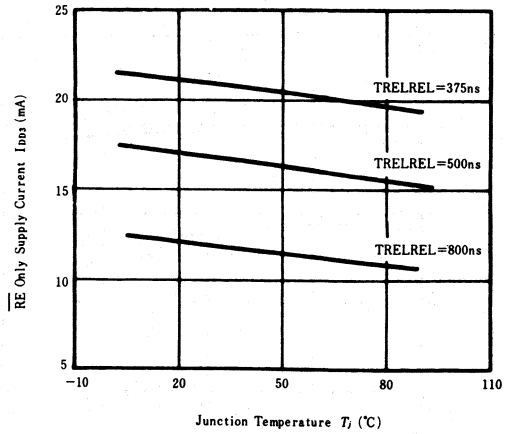

IDD4 (PAGE-MODE CYCLE) vs. V_{DD}

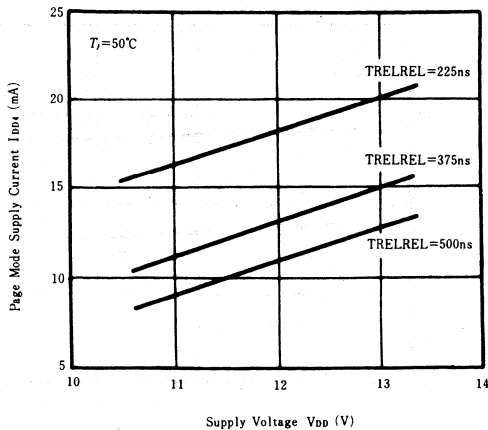

IDD4 (PAGE-MODE CYCLE) vs. T_j

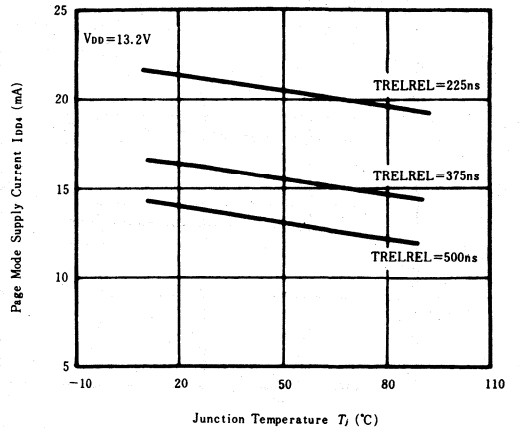

CLOCK INPUT LEVELS vs. V_{DD}

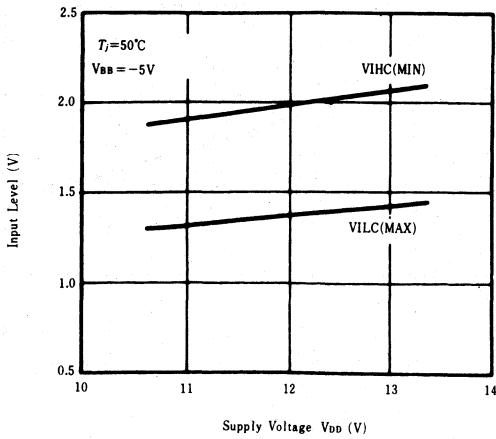

CLOCK INPUT LEVELS vs. V_{BB}

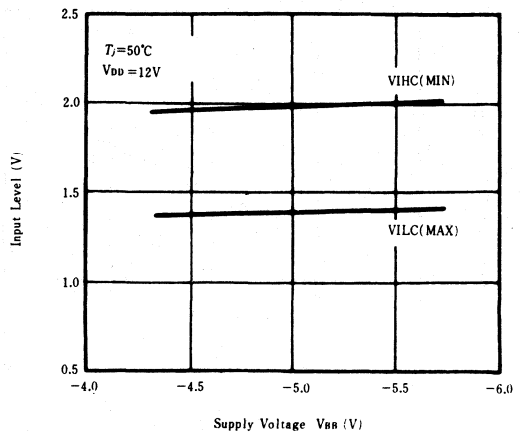

CLOCK INPUT LEVELS vs. T_j

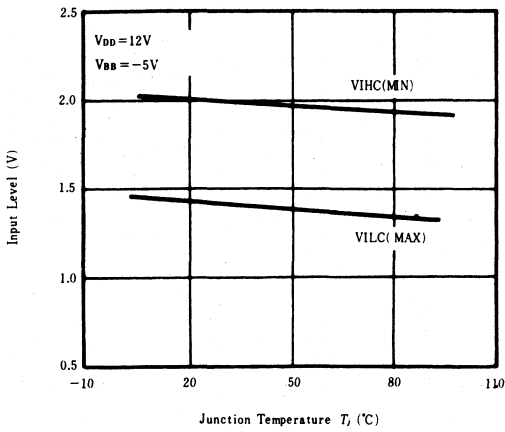

ADDRESS AND DATA INPUT LEVELS vs. V_{DD}

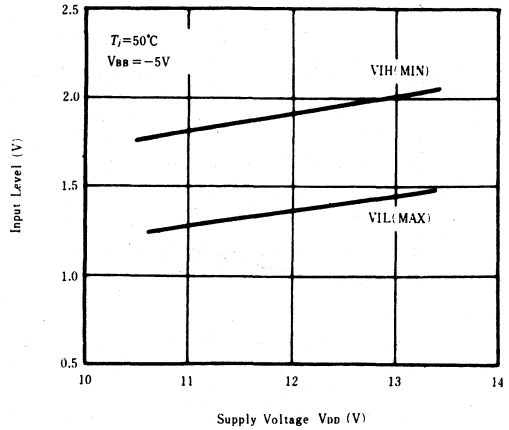

ADDRESS AND DATA INPUT LEVELS vs. V_{BB}

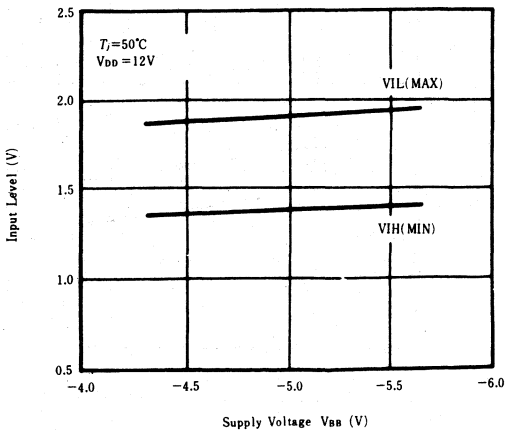

ADDRESS AND DATA INPUT LEVELS vs. T_j

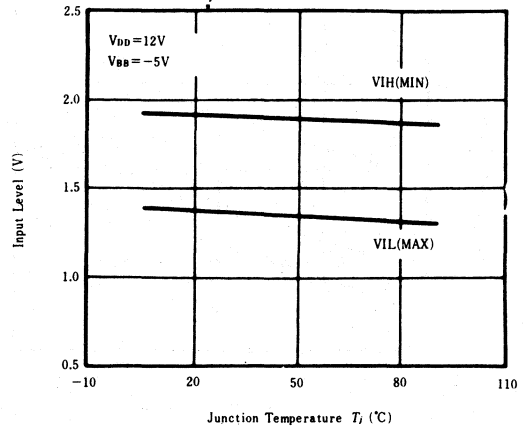

■ CURRENT WAVEFORMS

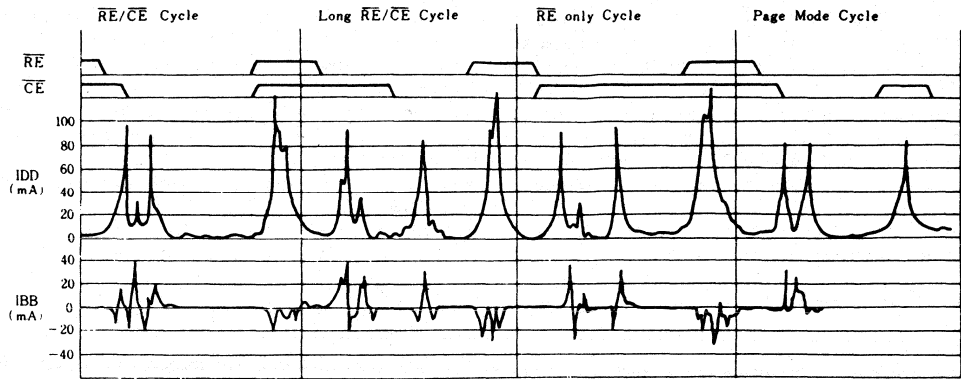

NOTE : VDD = 13.2V, VBB = -4.5V, Ta = 25°C

50ns

APPLICATION INFORMATION

• READ CYCLE;

A read cycle begins with addresses stable and a negative going transition of \overline{RE} . The time delay between the stable address and the start of \overline{RE} -on is controlled by parameter TAVREL.

Following the time when \overline{RE} reaches its low level, the row address must be held stable long enough to be captured.

This controlling parameter is TRELAX. Following this interval, the address can be changed from row address to column address.

When the column address is stable, \overline{CE} can be turned on. The leading edge of \overline{CE} is controlled by parameter TRELCEL.

The basic limit on the \overline{CE} leading edge is that \overline{CE} cannot start until the column address is stable, and this is controlled by parameter TAVCEL.

The column address must be held stable long enough to be captured.

The controlling parameter is TCELAX. Note that TRELCEL(max) is not an operating limit of the HM4716A though its specification is listed on the data sheets. If \overline{CE} becomes on later than TRELCEL(max), the access time from \overline{RE} will be increased by the time which TRELCEL exceeds TRELCEL(max).

Following the time when \overline{CE} reaches its low level, the data-out pin remains in a high impedance state until a valid data appears. This parameter is TCELQV-access time from \overline{CE} . The access time from \overline{RE} -TRELQV is the time from \overline{RE} -on to valid Q. The minimum value of TRELQV is derived as the sum of TRELCEL(max) and TCELQV. The selected output data is held valid internally until \overline{CE} becomes high, and then Q pin becomes high impedance. This parameter is TECHQZ.

• WRITE CYCLE;

A write cycle is performed by bringing \overline{W} low before or during \overline{CE} -on.

Two different write cycles can be defined as:

Write cycle — Write data are available at the beginning of the \overline{CE} -on so that the write operation starts at the beginning. In this mode, D and \overline{W} signal times are not in any critical path for determining cycle time.

Following the time when \overline{W} reaches its low level, \overline{W} must be held stable long enough to be captured. This \overline{W} -on pulse duration is called TWLWH.

The time required to capture write data in a latch is called TWLDX.

This cycle is called an "early write"

Read Write cycle — This cycle starts as a read cycle, but as soon as the device specification is met, a write cycle is initiated. \overline{W} and D are delayed until after Q. This cycle is called a "delayed write". A "Read-modify-write" cycle is a variation of this operation. In this mode, D and \overline{W} become critical path signals for determining cycle time.

• CLOCK-OFF TIMING;

\overline{RE} and \overline{CE} must stay on for Q stabilized to valid data. In the case of \overline{CE} , this is controlled by parameter TCELCEH (min). In the case of \overline{RE} , this controlled by parameter TCELREH(min).

Following the end of \overline{RE} , \overline{CE} must stay off long enough to precharge internal circuits. The only parameter of concern is TREHREL.

Normally \overline{CE} is not required to be off for a minimum time of TCEHREL.

However, in a page mode memory operation, there is a TCEHCEL(min) specification to control the \overline{CE} -off time.

• DATA OUTPUT;

Q is three-state TTL compatible with a fan-out of two standard TTL loads.

When \overline{CE} is high, Q is in a high impedance state. When \overline{CE} is low, valid data appears after TCELQV at a read cycle and Q is not valid at an early-write cycle.

• REFRESH;

Refresh of the HM4716A is accomplished by performing A memory cycle at each of the 128 row addresses within each two millisecond time interval.

Any cycle in which \overline{RE} signal occurs refreshes the entire selected row.

\overline{RE} -only refresh results in substantial reduction in operating power.

This reduction in power is reflected in the IDD3 specification.

• PAGE MODE;

Page mode operation allows faster successive memory operations at multiple column locations of the same row address with increased speed.

This is done by strobing the row address into the chip and maintaining \overline{RE} at a logic low throughout all successive \overline{CE} memory cycles in which the row address is latched. As the time normally required for strobing a new row address is eliminated, access and cycle times can be decreased and the operating power is reduced. These are reflected in the TCELQV, TCEHCEL, IDD4 specifications.

HM4816A-3, HM4816A-3E, HM4816A-4, HM4816A-7, HM4816AP-3, HM4816AP-3E, HM4816AP-4, HM4816AP-7

16384-word by 1-bit Dynamic Random Access Memory

The HM4816A is a new generation MOS dynamic RAM circuit organized as 16,384 words by 1 bit. As a state-of-the-art MOS memory device, the HM4816A (16K RAM) incorporates advanced circuit techniques designed to provide wide operating margins, both internally and to the system user, while achieving performance levels in speed and power.

The use of dynamic circuitry throughout, including sense amplifiers, assures that power dissipation is minimized without any sacrifice in speed or operating margin. These factors combine to make the HM4816A a truly superior RAM product. Multiplexed address inputs permits the HM4816A to be packaged in standard 16-pin DIP. Non-critical clock timing requirements allow use of the multiplexing technique while maintaining high performance.

■ FEATURES

- Single 5V supply
 - Low power standby and operation
(Standby: 11mW max., operation: 150mW max.)
- Fast access time & cycle time

	HM4816A-3 HM4816AP-3	HM4816A-3E HM4816AP-3E	HM4816A-4 HM4816AP-4	HM4816A-7 HM4816AP-7
Maximum Access Time (ns)	100	105	120	150
Read, Write Cycle (ns)	235	200	270	320
Read-Modify-Write Cycle (ns)	285	235	320	410

- Directly TTL compatible: All inputs & outputs
- Output data controlled by $\overline{\text{CAS}}$ and unlatched at end of cycle to allow two dimensional chip selection and extended page boundary.
- Common I/O capability using "easy write" operation.
- Read modify write, $\overline{\text{RAS}}$ only refresh and page mode capability
- Only 128 refresh cycle required every 2ms
- Compatible with Intel 2118-3/-4/-7

■ BLOCK DIAGRAM

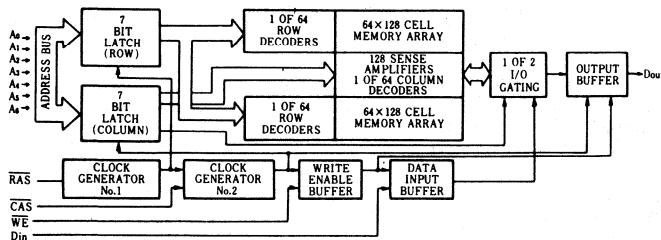

HM4816A-3, HM4816A-3E,
HM4816A-4, HM4816A-7

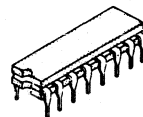

(DG-16B)

HM4816AP-3, HM4816AP-3E,
HM4816AP-4, HM4816AP-7

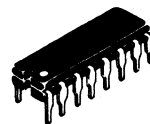

(DP-16)

■ PIN ARRANGEMENT

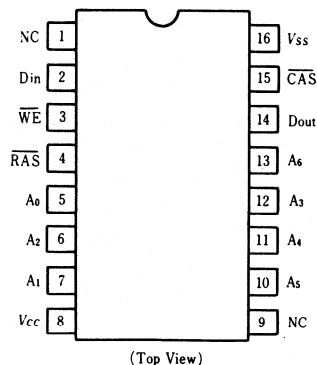

■ ABSOLUTE MAXIMUM RATINGS

Item	Symbol	HM4816A or AP	Unit
Voltage on any pin relative to GND	V_T	-1.0 ~ +7.0	V
Power supply voltage relative to GND	V_{CC}	-0.5 ~ +7.0	V
Short-circuit Output Current	I_{out}	50	mA
Power Dissipation	P_T	1.0	W
Operating Temperature	T_{op}	0 ~ +70	°C
Storage Temperature	Cerdip	-65 ~ +150	°C
	Plastic	-55 ~ +125	°C

■ RECOMMENDED DC OPERATING CONDITIONS

Item	Symbol	min	typ	max	Unit	Notes
Supply voltage	V_{CC}	4.5	5.0	5.5	V	1
	V_{SS}	0	0	0	V	1, 2
Input high (logic 1) voltage \overline{RAS} , \overline{CAS} , \overline{WE}	V_{IH}	2.4	—	7.0	V	1
Input high (logic 1) voltage except \overline{RAS} , \overline{CAS} , \overline{WE}	V_{IH}	2.4	—	7.0	V	1
Input low (logic 0) voltage all inputs	V_{IL}	-2.0	—	0.8	V	1

Notes : 1. All voltage referenced to V_{SS} .

2. Output voltage will swing from V_{SS} to V_{CC} when activated with no current loading.

■ DC AND OPERATING CHARACTERISTICS ⁽¹⁾

($T_a = 0^\circ\text{C}$ to 70°C , $V_{CC} = 5\text{V} \pm 10\%$, $V_{SS} = 0\text{V}$, unless otherwise noted.)

Parameter	Symbol	Test Conditions	min	typ ⁽²⁾	max	Unit	Notes
Input Load Current (any input)	$ I_{LI} $	$V_{IN} = V_{SS}$ to V_{CC}	—	0.1	10	μA	—
Output Leakage Current for High Impedance State	$ I_{LO} $	Chip Deselected; \overline{CAS} at V_{IH} , $V_{OUT} = 0$ to 5.5V	—	0.1	10	μA	
V_{CC} Supply Current. Standby	I_{CC1}	\overline{CAS} and \overline{RAS} at V_{IH}	—	1.2	2	mA	
		HM4816AP-3, 4, 7	—	1.2	3	mA	
		HM4816A, AP-3E	—	1.2	3	mA	
V_{CC} Supply Current. Operating	I_{CC2}	HM4816A, AP-3 $t_{RC} = t_{RCMIN}$	—	23	27	mA	3
		HM4816A, AP-3E $t_{RC} = t_{RCMIN}$	—	27	35	mA	3
		HM4816A, AP-4 $t_{RC} = t_{RCMIN}$	—	21	25	mA	3
		HM4816A, AP-7 $t_{RC} = t_{RCMIN}$	—	19	23	mA	3
V_{CC} Supply Current; \overline{RAS} -Only Cycle	I_{CC3}	HM4816A, AP-3 $t_{RC} = t_{RCMIN}$	—	16	18	mA	3
		HM4816A, AP-3E $t_{RC} = t_{RCMIN}$	—	20	25	mA	3
		HM4816A, AP-4 $t_{RC} = t_{RCMIN}$	—	14	16	mA	3
		HM4816A, AP-7 $t_{RC} = t_{RCMIN}$	—	12	14	mA	3
V_{CC} Supply Current. Standby. Output Enabled	I_{CC5}	\overline{CAS} at V_{IL} , \overline{RAS} at V_{IH}	—	3	6	mA	3
Output Low Voltage	V_{OL}	$I_{OL} = 4.2\text{mA}$	0	—	0.4	V	
Output High Voltage	V_{OH}	$I_{OH} = -5\text{mA}$	2.4	—	V_{CC}	V	

Notes : 1. All voltages referenced to V_{SS} .

2. Typical values are for $T_a = 25^\circ\text{C}$ and nominal supply voltages.

3. I_{CC} is dependent on output loading when the devices output is selected. Specified I_{CC} MAX is measured with the output open.

■ CAPACITANCE ($T_a = 25^\circ\text{C}$, $V_{CC} = 5\text{V} \pm 10\%$, $V_{SS} = 0\text{V}$, unless otherwise noted.)

Parameter	Symbol	typ	max	Unit
Address. Data In	C_{I1}	3	5	pF
\overline{RAS} , \overline{CAS} , \overline{WE} , Data Out	C_{I2}	4	7	pF

Notes : Capacitance measured with Boonton Meter or effective capacitance calculated from the equation:

$$C = \frac{I \Delta t}{\Delta V} \text{ with } \Delta V \text{ equal to 3 volts and power supplies at nominal levels.}$$

■ AC CHARACTERISTICS ^(1,2,3) ($T_a=0^\circ\text{C}$ to 70°C , $V_{CC}=5V\pm 10\%$, $V_{SS}=0V$, unless otherwise noted.)

● READ, WRITE, READ-MODIFY-WRITE AND REFRESH CYCLES

Parameter	Symbol	HM4816A-3 HM4816AP-3		HM4816A-3E HM4816AP-3E		HM4816A-4 HM4816AP-4		HM4816A-7 HM4816AP-7		Unit	Notes
		min	max	min	max	min	max	min	max		
Access Time From RAS	t_{RAC}	—	100	—	105	—	120	—	150	ns	4, 5
Access Time From CAS	t_{CAC}	—	55	—	60	—	65	—	80	ns	4, 5, 6
Time Between Refresh	t_{REF}	—	2	—	2	—	2	—	2	ms	
RAS Precharge Time	t_{RP}	110	—	70	—	120	—	135	—	ns	
CAS Precharge Time (non-page cycles)	t_{CPN}	50	—	50	—	55	—	70	—	ns	
CAS to RAS Precharge Time	t_{CRP}	0	—	0	—	0	—	0	—	ns	
RAS to CAS Delay Time	t_{RCD}	25	45	25	45	25	55	25	70	ns	7
RAS Hold Time	t_{RSH}	70	—	60	—	85	—	105	—	ns	
CAS Hold Time	t_{CSH}	100	—	105	—	120	—	165	—	ns	
Row Address Set-up Time	t_{ASR}	0	—	0	—	0	—	0	—	ns	
Row Address Hold Time	t_{RAH}	15	—	15	—	15	—	15	—	ns	
Column Address Set-up Time	t_{ASC}	0	—	0	—	0	—	0	—	ns	
Column Address Hold Time	t_{CAH}	15	—	25	—	20	—	20	—	ns	
Column Address Hold Time to RAS	t_{LAR}	60	—	70	—	75	—	90	—	ns	
Transition Time (Rise and Fall)	t_T	3	50	3	50	3	50	3	50	ns	8
Output Buffer Turn Off Delay	t_{OFF}	0	45	0	50	0	50	0	60	ns	

● READ AND REFRESH CYCLES

Random Read Cycle Time	t_{RC}	235	—	200	—	270	—	320	—	ns	
RAS Pulse Width	t_{RAS}	115	10000	105	10000	140	10000	175	10000	ns	
CAS Pulse Width	t_{CAS}	55	10000	60	10000	65	10000	95	10000	ns	
Read Command Set-up Time	t_{RCS}	0	—	0	—	0	—	0	—	ns	
Read Command Hold Time	t_{RCH}	10	—	10	—	10	—	10	—	ns	

● WRITE CYCLE

Random Write Cycle Time	t_{RC}	235	—	200	—	270	—	320	—	ns	
RAS Pulse Width	t_{RAS}	115	10000	105	10000	140	10000	175	10000	ns	
CAS Pulse Width	t_{CAS}	55	10000	60	10000	65	10000	95	10000	ns	
Write Command Set-up Time	t_{WCS}	0	—	0	—	0	—	0	—	ns	9
Write Command Hold Time	t_{WCH}	25	—	30	—	30	—	45	—	ns	
Write Command Hold Time to RAS	t_{WCR}	70	—	75	—	85	—	115	—	ns	
Write Command Pulse Width	t_{WCP}	25	—	30	—	30	—	50	—	ns	
Write Command to RAS Lead Time	t_{RWL}	60	—	45	—	65	—	110	—	ns	
Write Command to CAS Lead Time	t_{CWL}	45	—	45	—	50	—	100	—	ns	
Data-in Set-up Time	t_{DS}	0	—	0	—	0	—	0	—	ns	
Data-in Hold Time	t_{DH}	25*	—	30	—	30	—	45	—	ns	
Data-in Hold Time to RAS	t_{DHR}	70	—	75	—	85	—	115	—	ns	

● READ-MODIFY-WRITE CYCLE

Read-Modify-Write Cycle Time	t_{RWC}	285	—	235	—	320	—	410	—	ns	
RMW Cycle RAS Pulse Width	t_{RRW}	165	10000	155	10000	190	10000	265	10000	ns	
RMW Cycle CAS Pulse Width	t_{CRW}	105	10000	110	10000	120	10000	185	10000	ns	
RAS to WE Delay	t_{RWD}	100	—	105	—	120	—	150	—	ns	9
CAS to WE Delay	t_{CWD}	55	—	60	—	65	—	80	—	ns	9

Notes:

1. All voltages referenced to V_{SS}
2. Eight cycles are required after power-up or prolonged periods (greater than 2ms) of RAS inactivity before proper device operation is achieved. Any 8 cycles which perform refresh are adequate for this purposes.
3. AC Characteristics assume $t_T=5ns$
4. Assume that $t_{RCD} \leq t_{RCD}(\max.)$ If t_{RCD} is greater than $t_{RCD}(\max.)$ then t_{RAC} will increase by the amount that t_{RCD} exceeds $t_{RCD}(\max.)$
5. Load = 2 TTL Loads and 100pF
6. Assumes $t_{RCD} \geq t_{RCD}(\max.)$
7. $t_{RCD}(\max.)$ is specified as a reference point only. If t_{RCD} is less than $t_{RCD}(\max.)$ access time is t_{RAC} . If t_{RCD} is greater than $t_{RCD}(\max.)$ access time is $t_{RCD} + t_{CAC}$.
8. t_T is measured between $V_{IH}(\min.)$ and $V_{IL}(\max.)$
9. t_{WCS} , t_{CWD} and t_{RWD} are specified as reference points only. If $t_{WCS} \geq t_{WCS}(\min.)$ the cycle is an early write cycle and the data out pin will remain high impedance throughout the entire cycle. If $t_{CWD} \geq t_{CWD}(\min.)$ and $t_{RWD} \geq t_{RWD}(\min.)$, the cycle is a read-modify-write cycle and the data out will contain the data read from the selected address if neither of the above conditions is satisfied, the condition on the data out is indeterminate.

■ WAVEFORMS

● READ CYCLE

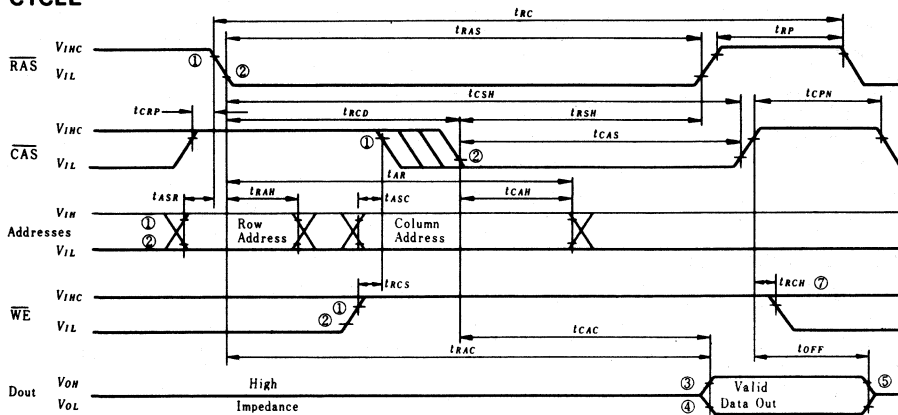

● WRITE CYCLE

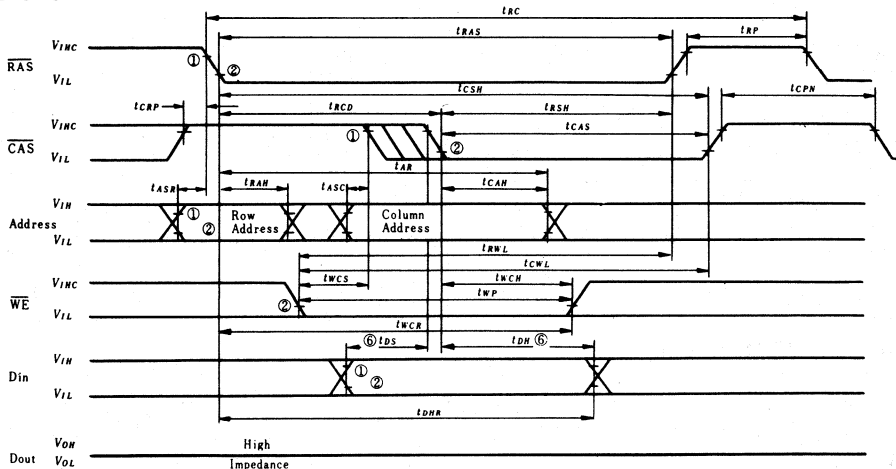

Notes:

- 1.2. $V_{IH}(\min.)$ and $V_{IL}(\max.)$ are reference levels for measuring timing of input signals.
- 3.4. $V_{OH}(\min.)$ and $V_{OL}(\max.)$ are reference levels for measuring timing of DOUT.
5. t_{OFF} is measured to $I_{OUT} < I_{LO}$.
6. t_{DS} and t_{DH} are referenced to \overline{CAS} or \overline{WE} , whichever occurs last.
7. t_{RCH} is referenced to the trailing edge of \overline{CAS} or \overline{RAS} , whichever occurs first.
8. t_{CRP} requirement is only applicable for $\overline{RAS}/\overline{CAS}$ cycles preceded by a \overline{CAS} -only cycle (i.e., for system where \overline{CAS} has not been decoded with \overline{RAS}).

● READ-MODIFY-WRITE CYCLE

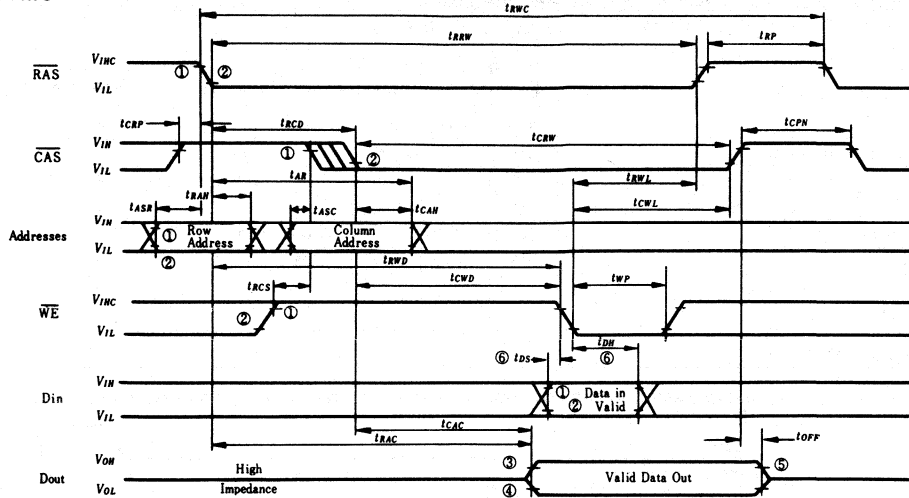

● RAS-ONLY REFRESH CYCLE

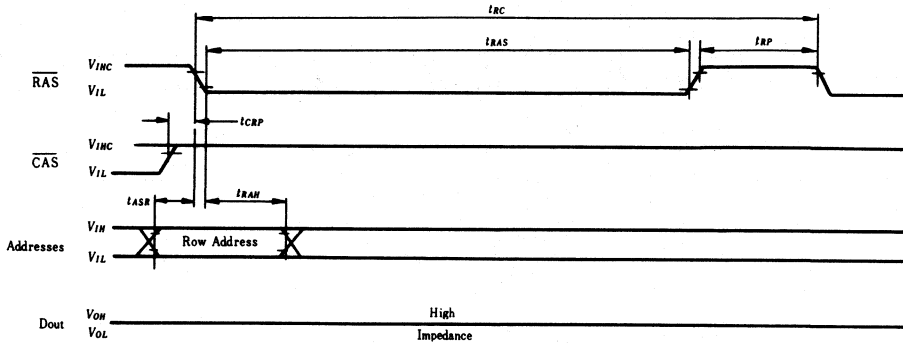

● HIDDEN REFRESH CYCLE

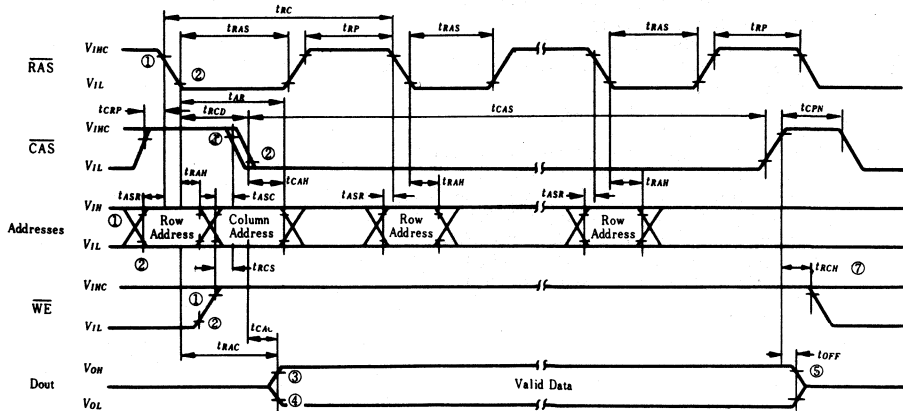

Notes:

- 1.2. $V_{IH\ MIN}$ and $V_{IL\ MAX}$ and reference levels for measuring timing of input signals.
- 3.4. $V_{OH\ MIN}$ and $V_{OL\ MAX}$ are reference levels for measuring timing of DOUT.
5. t_{OFF} is measured to $I_{OUT} \leq I_{LOL}$.
6. t_{DS} and t_{DH} are referenced to \overline{CAS} or \overline{WE} , whichever occurs last.
7. t_{RCH} is referenced to the trailing edge of \overline{CAS} or \overline{RAS} , whichever occurs first.
8. t_{CRP} requirement is only applicable for $\overline{RAS}/\overline{CAS}$ - cycles preceded by a \overline{CAS} -only cycle (i.e., for systems where \overline{CAS} has not been decoded with \overline{RAS}).

■ DC AND AC CHARACTERISTICS, PAGE MODE (7.8.)

($T_a=0^{\circ}\text{C}$ to 70°C , $V_{CC}=5\text{V}\pm 10\%$, $V_{SS}=0\text{V}$, unless otherwise noted.)

Parameter	Symbol	HM4816A-3 HM4816AP-3		HM4816A-3E HM4816AP-3E		HM4816A-4 HM4816AP-4		HM4816A-7 HM4816AP-7		Unit
		min.	max.	min.	max.	min.	max.	min.	max.	
Page Mode Read or Write Cycle	t_{PC}	125	—	130	—	145	—	190	—	ns
Page Mode Read Modify Write Cycle	t_{PCM}	175	—	180	—	200	—	280	—	ns
CAS Precharge Time, Page Cycle	t_{CP}	60	—	60	—	70	—	85	—	ns
RAS Pulse Width, Page Mode	t_{RPM}	115	10000	105	10000	140	10000	175	10000	ns
CAS Pulse Width	t_{CAS}	55	10000	60	10000	65	10000	95	10000	ns
V_{DD} Supply Current Page Mode. Minimum t_{PC} , Minimum t_{CAS}	I_{DDA}	—	23	—	23	—	21	—	18	mA

● PAGE MODE READ CYCLE

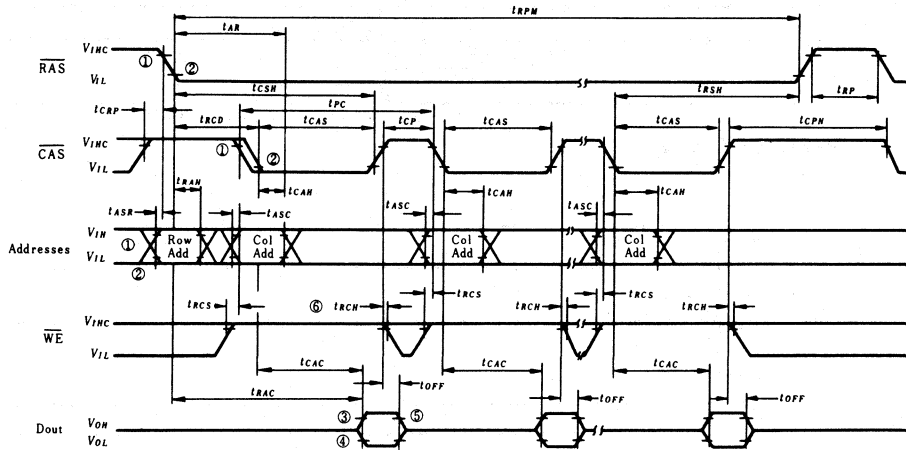

- Notes:
- 1.2. $V_{IH MIN}$ and $V_{IL MAX}$ are reference levels for measuring timing of input signals.
 - 3.4. $V_{OH MIN}$ and $V_{OL MAX}$ are reference levels for measuring timing of DOUT.
 5. t_{OFF} is measured to $I_{OUT} \leq |I_{LO}|$.
 6. t_{RCH} is referenced to the trailing edge of $\overline{\text{CAS}}$ or $\overline{\text{RAS}}$, whichever occurs first.
 7. All voltages referenced to V_{SS} .
 8. AC Characteristic assume $t_T=5\text{ns}$.
 9. See the typical characteristics section for values of this parameter under alternate conditions.
 10. t_{CRP} requirement is only applicable for $\overline{\text{RAS/CAS}}$ cycles preceded by a CAS-only cycle (i.e., for systems where $\overline{\text{CAS}}$ has not been decoded with $\overline{\text{RAS}}$).
 11. All previous specified A. C. and D. C. characteristics are applicable to their respective page mode device.

● PAGE MODE WRITE CYCLE

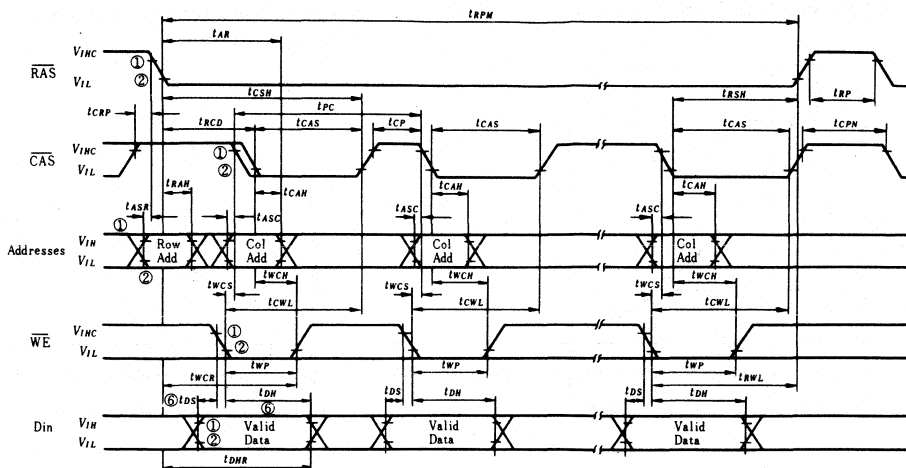

● PAGE MODE READ-MODIFY-WRITE CYCLE

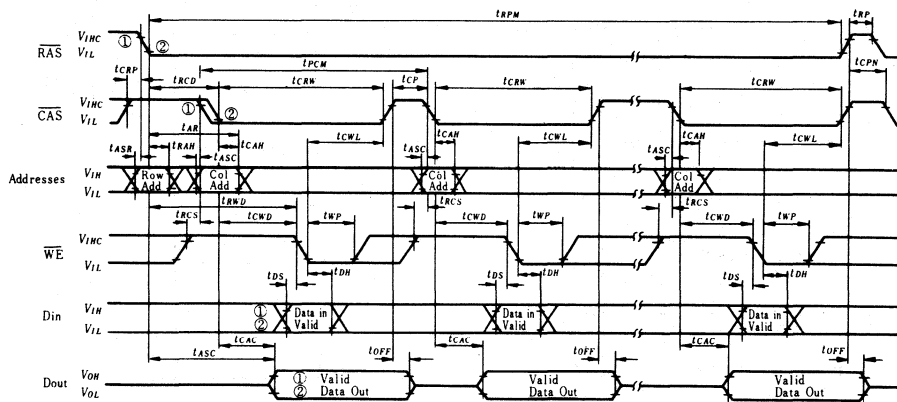

- 1.2. $V_{IH\ MIN}$ and $V_{IL\ MAX}$ are reference levels for measuring timing of input signals.
- 3.4. $V_{OH\ MIN}$ and $V_{OL\ MAX}$ are reference levels for measuring timing of D_{OUT} .
5. t_{OFF} is measured to $I_{OUT} \leq 1\ \mu A$.
6. t_{DS} and t_{DH} are referenced to \overline{CAS} or \overline{WE} , whichever occurs last.
7. t_{RCH} is referenced to the trailing edge of \overline{CAS} or \overline{RAS} , whichever occurs first.
8. t_{CRP} requirement is only applicable for $\overline{RAS}/\overline{CAS}$ cycles preceded by a \overline{CAS} -only cycle (i.e., for systems where \overline{CAS} has not been decoded with \overline{RAS}).

● Typical Characteristics of HM4816A

TYPICAL ACCESS TIME t_{CAC} vs. V_{CC}

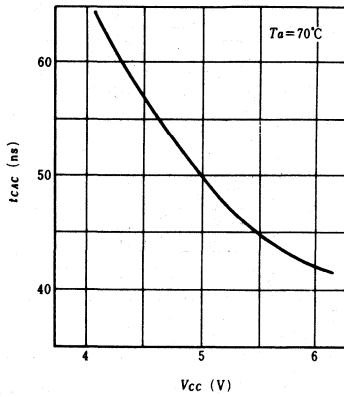

TYPICAL OPERATING CURRENT I_{CC2} vs. CYCLE RATE

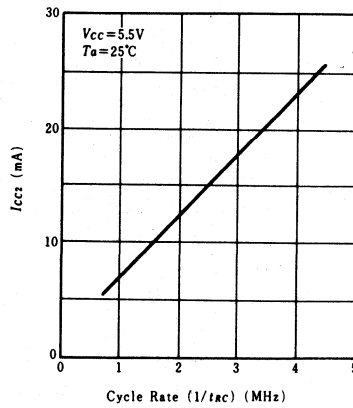

TYPICAL STANDBY CURRENT I_{CC1} vs. V_{CC}

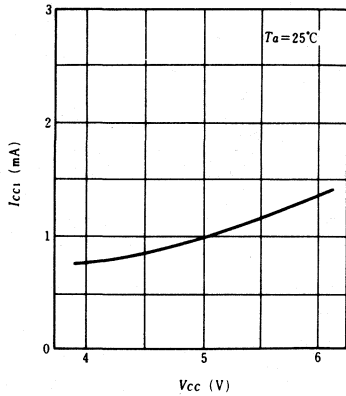

TYPICAL OPERATING CURRENT I_{CC2} vs. V_{CC}

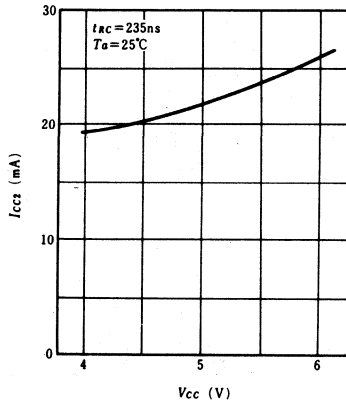

● TYPICAL SUPPLY CURRENT WAVEFORMS

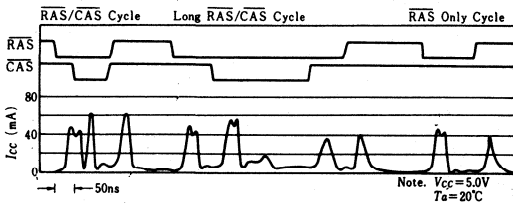

TYPICAL I_{CC} vs. V_{CC} DURING POWER UP

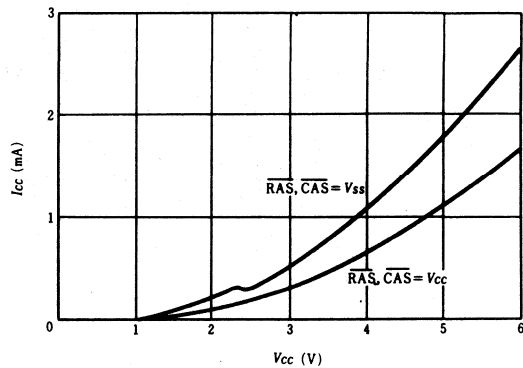

HM4864-2, HM4864-3 HM4864P-2, HM4864P-3

65536-word × 1-bit Dynamic Random Access Memory

The HM4864 is a 65,536-words by 1-bit, MOS random access memory circuit fabricated with HITACHI's double-poly N-channel silicon gate process for high performance and high functional density. The HM4864 uses a single transistor dynamic storage cell and dynamic control circuitry to achieve high speed and low power dissipation.

Multiplexed address inputs permit the HM4864 to be packaged in a standard 16 pin DIP on 0.3 inch centers.

This package size provides high system bit densities and is compatible with widely available automated testing and insertion equipment. System oriented features include single power supply of +5V with $\pm 10\%$ tolerance, direct interfacing capability with high performance logic families such as Schottky TTL, maximum input noise immunity to minimize "false triggering" of the inputs, on-chip address and data registers which eliminate the need for interface registers, and two chip select methods to allow the user to determine the appropriate speed/power characteristics of this memory system. The HM4864 also incorporates several flexible timing/operating modes.

In addition to the usual read, write, and read-modify-write cycles, the HM4864 is capable of delayed write cycles, page-mode operation and $\overline{\text{RAS}}$ -only refresh.

Proper control of the clock inputs ($\overline{\text{RAS}}$, $\overline{\text{CAS}}$, and $\overline{\text{WE}}$) allows common I/O capability, two dimensional chip selection, and extended page boundaries (when operating in page mode).

FEATURES

- Recognized industry standard 16-pin configuration
- 150ns access time, 270ns cycle time (HM4864-2, HM4864P-2)
- 200ns access time, 335ns cycle time (HM4864-3, HM4864P-3)
- Single power supply of +5V $\pm 10\%$ with a built-in V_{BB} generator
- Low Power; 330 mW active, 20 mW standby (max)
- The inputs TTL compatible, low capacitance, and protected against static charge
- Output data controlled by $\overline{\text{CAS}}$ and unlatched at end of cycle to allow two dimensional chip selection and extended page boundary
- Common I/O capability using "early write" operation
- Read-Modify-Write, $\overline{\text{RAS}}$ -only refresh, and Page-mode capability
- 128 refresh cycle

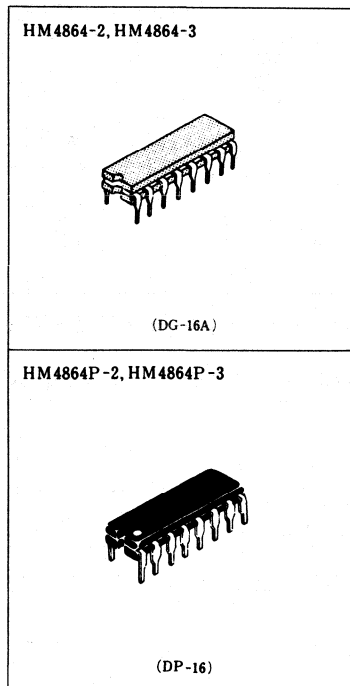

PIN ARRANGEMENT

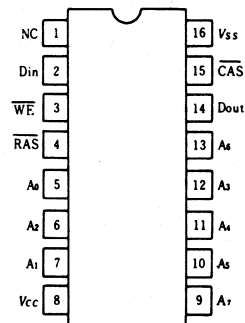

(Top View)

A_0-A_7	Address Inputs
$\overline{\text{CAS}}$	Column Address Strobe
Din	Data In
Dout	Data Out
$\overline{\text{RAS}}$	Row Address Strobe
$\overline{\text{WE}}$	Read/Write Input
V_{CC}	Power (+5V)
V_{SS}	Ground
A_0-A_6	Refresh Address Input

FUNCTIONAL BLOCK DIAGRAM

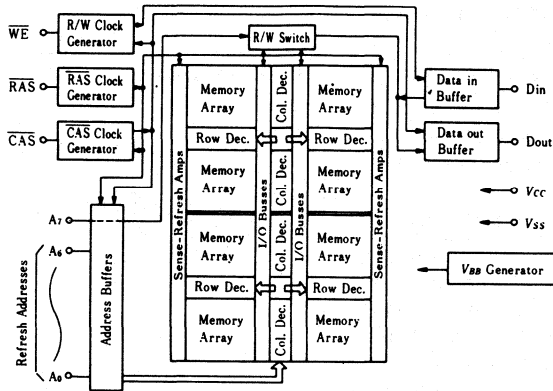

ABSOLUTE MAXIMUM RATINGS

Voltage on any pin relative to V_{SS} -1.0 to +7V
 Operating Temperature, T_a (Ambient) 0 to +70°C
 Storage Temperature (Ambient) -65 to +150°C (Cerdip)
 -55 to +125°C (Plastic)
 Short-circuit Output Current 50 mA
 Power Dissipation 1 W

RECOMMENDED DC OPERATING CONDITIONS ($T_a=0$ to +70°C)

Parameter	Symbol	min	typ	max	Unit	Notes
Supply Voltage	V_{CC}	4.5	5.0	5.5	V	1
	V_{SS}	0	0	0	V	
Input High Voltage	V_{IH}	2.4	—	6.5	V	1
Input Low Voltage	V_{IL}	-1.0	—	0.8	V	1

DC ELECTRICAL CHARACTERISTICS ($T_a=0$ to +70°C, $V_{CC}=5V \pm 10\%$, $V_{SS}=0V$)

Parameter	Symbol	min	max	Unit	Notes
OPERATING CURRENT					
Average Power Supply Operating Current (\overline{RAS} , \overline{CAS} Cycling; $t_{RC} = \text{min.}$)	I_{CC1}	—	60	mA	2, 4
STANDBY-CURRENT					
Power Supply Standby Current ($\overline{RAS} = V_{IH}$, DOUT = High Impedance)	I_{CC2}	—	3.5	mA	2
REFRESH CURRENT					
Average Power Supply Current, Refresh Mode (\overline{RAS} Cycling, $CAS = V_{IH}$; $t_{RC} = \text{min.}$)	I_{CC3}	—	45	mA	2, 4
PAGE MODE CURRENT					
Average Power Supply Current, Page-mode Operation ($\overline{RAS} = V_{IL}$, \overline{CAS} Cycling; $t_{PC} = \text{min.}$)	I_{CC4}	—	45	mA	2, 4
INPUT LEAKAGE					
Input Leakage Current, any Input ($V_{in} = 0$ to +6.5V, all other pins not under test = 0V)	I_{LI}	-10	10	μA	
OUTPUT LEAKAGE					
Output Leakage Current (Dout is disabled, $V_{out} = 0$ to +5.5V)	I_{LO}	-10	10	μA	3
OUTPUT LEVELS					
Output High (Logic 1) Voltage ($I_{out} = -5\text{mA}$)	V_{OH}	2.4	V_{CC}	V	
Output Low (Logic 0) Voltage ($I_{out} = 4.2\text{mA}$)	V_{OL}	0	0.4	V	

NOTES

1. All voltages referenced to V_{SS} .
2. I_{CC} depends on output loading condition when the device is selected. I_{CC} max. is specified at the output open condition.
3. I_{LO} consists of leakage current only.
4. Current depends on cycle rate: maximum current is measured at the fastest cycle rate.

AC ELECTRICAL CHARACTERISTICS

Parameter	Symbol	typ	max	Unit	Notes
Input Capacitance (A_0-A_7 , Din)	C_{in1}	—	7	pF	1
Input Capacitance (\overline{RAS} , \overline{CAS} , \overline{WE})	C_{in2}	—	10	pF	1
Output Capacitance (Dout)	C_{out}	—	7	pF	1, 2

NOTES

1. Capacitance measured with Boonton Meter or effective capacitance measuring method.
2. $CAS = V_{IH}$ to disable D_{OUT} .

ELECTRICAL CHARACTERISTICS AND RECOMMENDED AC OPERATING CONDITIONS ^{1), 2)}

($T_a=0$ to $+70^\circ\text{C}$, $V_{CC}=5\text{V}\pm 10\%$, $V_{SS}=0\text{V}$)

Parameter	Symbol	HM4864-2/P-2		HM4864-3/P-3		Unit	Notes
		min	max	min	max		
Random Read or Write Cycle Time	t_{RC}	270	—	335	—	ns	
Read-Write Cycle Time	t_{RWC}	270	—	335	—	ns	
Page Mode Cycle Time	t_{PC}	170	—	225	—	ns	
Access Time from $\overline{\text{RAS}}$	t_{RAC}	—	150	—	200	ns	4, 6
Access Time*from $\overline{\text{CAS}}$	t_{CAC}	—	100	—	135	ns	5, 6
Output Buffer Turn-off Delay	t_{OFF}	0	40	0	50	ns	7
Transition Time (Rise and Fall)	t_T	3	35	3	50	ns	3
$\overline{\text{RAS}}$ Precharge Time	t_{RP}	100	—	120	—	ns	
$\overline{\text{RAS}}$ Pulse Width	t_{RAS}	150	10000	200	10000	ns	
$\overline{\text{RAS}}$ Hold Time	t_{RSH}	100	—	135	—	ns	
$\overline{\text{CAS}}$ Pulse Width	t_{CAS}	100	—	135	—	ns	
$\overline{\text{CAS}}$ Hold Time	t_{CSH}	150	—	200	—	ns	
$\overline{\text{RAS}}$ to $\overline{\text{CAS}}$ Delay Time	t_{RCD}	20	50	25	65	ns	8
$\overline{\text{CAS}}$ to $\overline{\text{RAS}}$ Precharge Time	t_{CRP}	-20	—	-20	—	ns	
Row Address Set-up Time	t_{ASR}	0	—	0	—	ns	
Row Address Hold Time	t_{RAH}	20	—	25	—	ns	
Column Address Set-up Time	t_{ASC}	-10	—	-10	—	ns	
Column Address Hold Time	t_{CAH}	45	—	55	—	ns	
Column Address Hold Time referenced to $\overline{\text{RAS}}$	t_{AR}	95	—	120	—	ns	
Read Command Set-up Time	t_{RCS}	0	—	0	—	ns	
Read Command Hold Time	t_{RCH}	0	—	0	—	ns	
Write Command Hold Time	t_{WCH}	45	—	55	—	ns	
Write Command Hold Time referenced to $\overline{\text{RAS}}$	t_{WCR}	95	—	120	—	ns	
Write Command Pulse Width	t_{WP}	45	—	55	—	ns	
Write Command to $\overline{\text{RAS}}$ Lead Time	t_{RWL}	45	—	55	—	ns	
Write Command to $\overline{\text{CAS}}$ Lead Time	t_{CWL}	45	—	55	—	ns	
Data-in Set-up Time	t_{DS}	0	—	0	—	ns	9
Data-in Hold Time	t_{DH}	45	—	55	—	ns	9
Data-in Hold Time referenced to $\overline{\text{RAS}}$	t_{DHR}	95	—	120	—	ns	
$\overline{\text{CAS}}$ Precharge Time (for Page-mode Cycle Only)	t_{CP}	60	—	80	—	ns	
Refresh Period	t_{REF}	—	2	—	2	ms	
Write Command Set-up Time	t_{WCS}	-20	—	-20	—	ns	10
$\overline{\text{CAS}}$ to $\overline{\text{WE}}$ Delay	t_{CWD}	60	—	80	—	ns	10
$\overline{\text{RAS}}$ to $\overline{\text{WE}}$ Delay	t_{RWD}	110	—	145	—	ns	10
$\overline{\text{RAS}}$ Precharge to $\overline{\text{CAS}}$ Hold Time	t_{RPC}	0	—	0	—	ns	

NOTES

- AC measurements assume $t_T = 5\text{ns}$.
- 8 cycles are required after power-on or prolonged periods (greater than 2ms) of $\overline{\text{RAS}}$ inactivity before proper device operation is achieved. Any 8 cycles which perform refresh are adequate for this purpose.
- V_{IH} (min) and V_{IL} (max) are reference levels for measuring timing of input signals. Also, transition times are measured between V_{IH} and V_{IL} .
- Assumes that $t_{RCD} \leq t_{RCD}(\text{max})$. If t_{RCD} is greater than the maximum recommended value shown in this table t_{RAC} exceeds the value shown.
- Assumes that $t_{RCD} \geq t_{RCD}(\text{max})$.
- Measured with a load circuit equivalent to 2TTL loads and 100 pF.
- $t_{OFF}(\text{max})$ defines the time at which the output achieves the open circuit condition and is not referenced to output voltage levels.
- Operation with the $t_{RCD}(\text{max})$ limit insures that

$t_{RAC}(\text{max})$ can be met, $t_{RCD}(\text{max})$ is specified as a reference point only; if t_{RCD} is greater than the specified $t_{RCD}(\text{max})$ limit, then access time is controlled exclusively by t_{CAC} .

- These parameters are reference to $\overline{\text{CAS}}$ leading edge in early write cycles and to $\overline{\text{WE}}$ leading edge in delayed write or read-modify-write cycles.
- t_{WCS} , t_{CWD} and t_{RWD} are not restrictive operating parameters. They are included in the data sheet as electrical characteristics only: if $t_{WCS} \geq t_{WCS}(\text{min})$, the cycle is an early write cycle and the data out pin will remain open circuit (high impedance) throughout the entire cycle; if $t_{CWD} \geq t_{CWD}(\text{min})$ and $t_{RWD} \geq t_{RWD}(\text{min})$ the cycle is a read/write and the data output will contain data read from the selected cell; if neither of the above sets of conditions is satisfied the condition of the data out (at access time) is indeterminate.

■ TIMING WAVEFORMS

● READ CYCLE

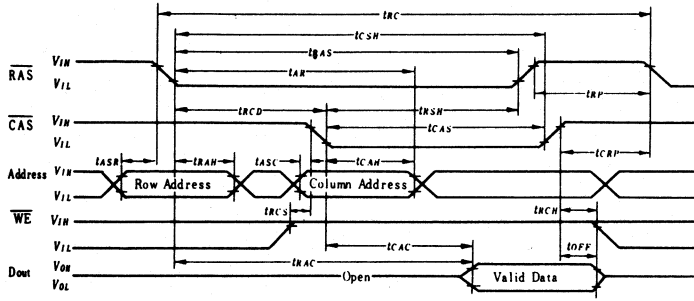

● WRITE CYCLE

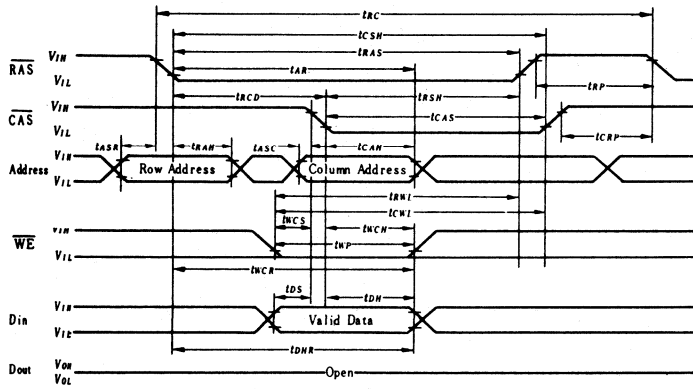

● READ-WRITE/READ-MODIFY-WRITE CYCLE

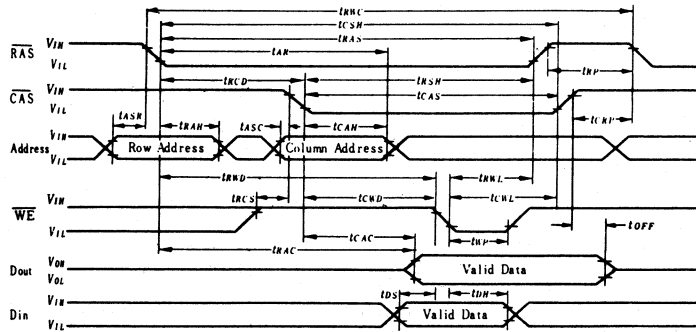

● "RAS-ONLY" REFRESH CYCLE

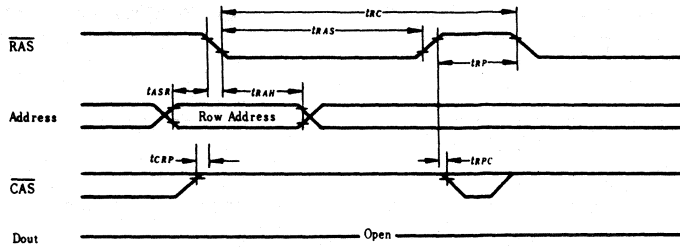

● PAGE MODE READ CYCLE

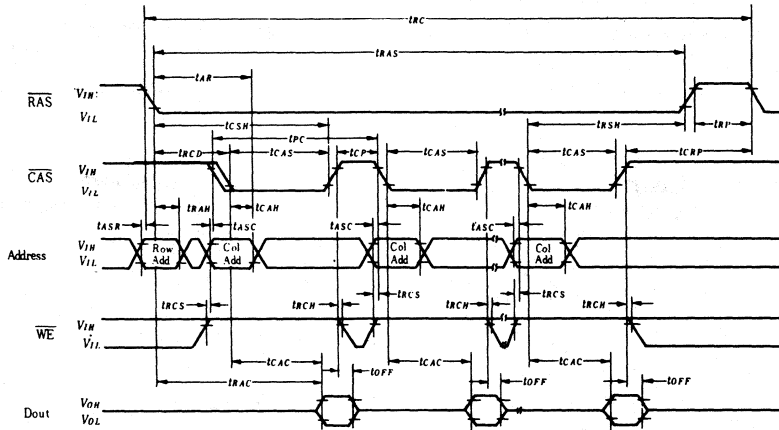

● PAGE MODE WRITE CYCLE

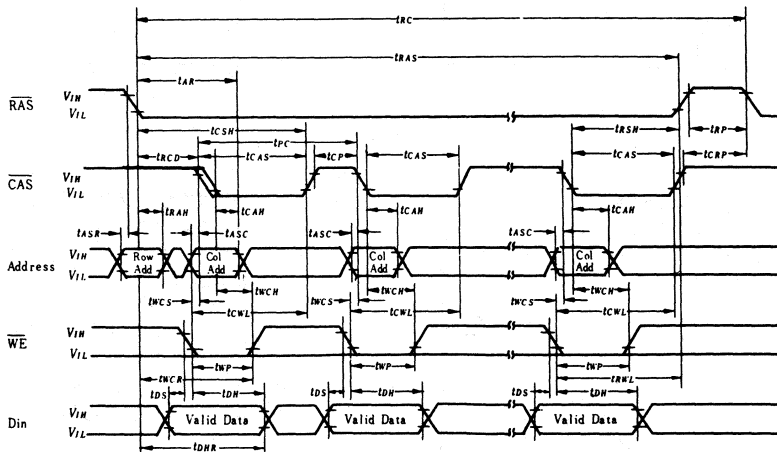

■ TYPICAL CHARACTERISTICS

ACCESS TIME
vs. SUPPLY VOLTAGE

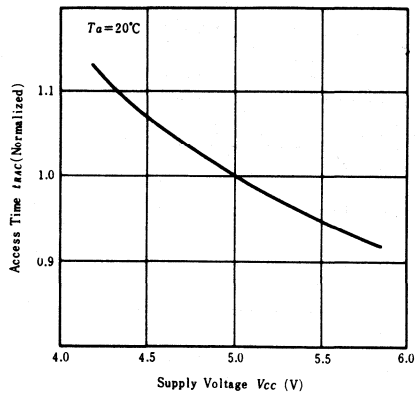

ACCESS TIME
vs. AMBIENT TEMPERATURE

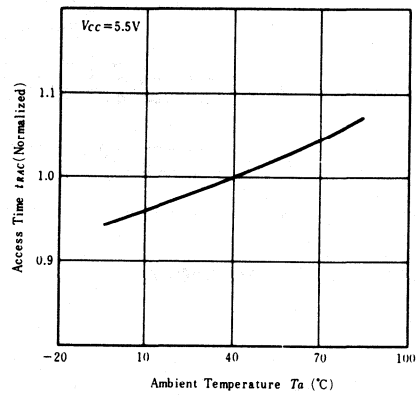

SUPPLY CURRENT
vs. SUPPLY VOLTAGE

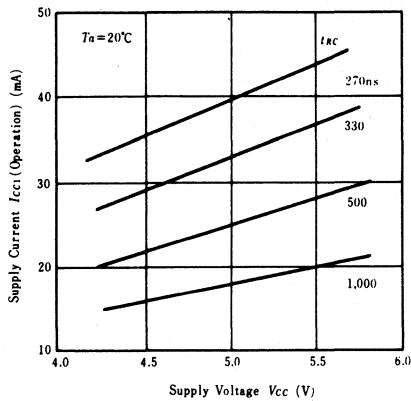

SUPPLY CURRENT
vs. AMBIENT TEMPERATURE

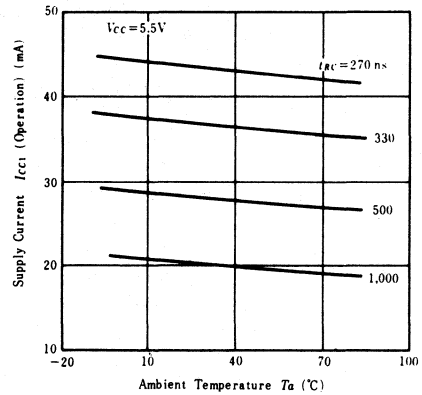

SUPPLY CURRENT
vs. CYCLE RATE

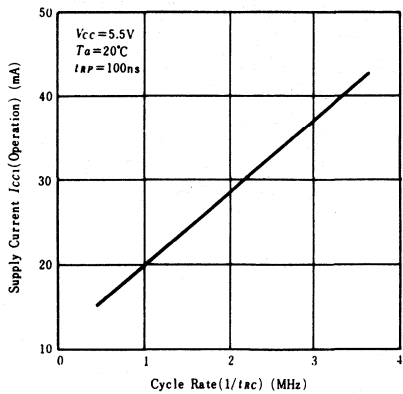

SUPPLY CURRENT
vs. SUPPLY VOLTAGE

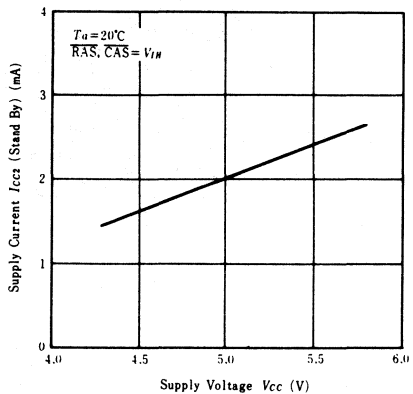

SUPPLY CURRENT vs. AMBIENT TEMPERATURE

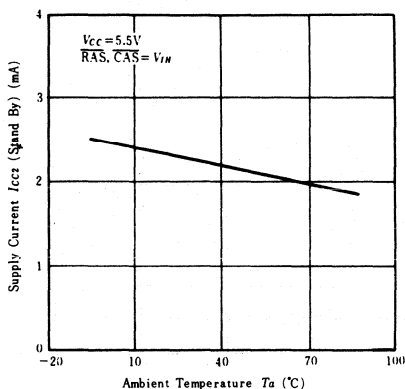

SUPPLY CURRENT vs. SUPPLY VOLTAGE

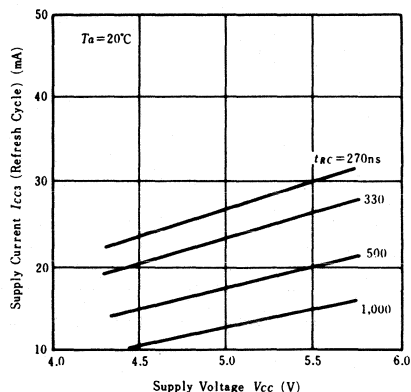

SUPPLY CURRENT vs. AMBIENT TEMPERATURE

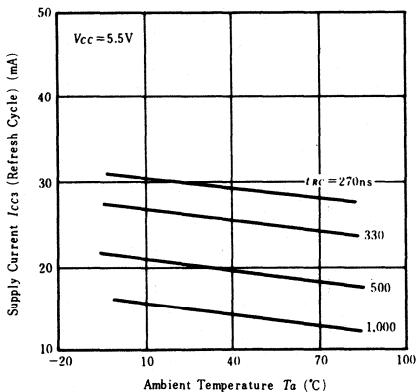

SUPPLY CURRENT vs. CYCLE RATE

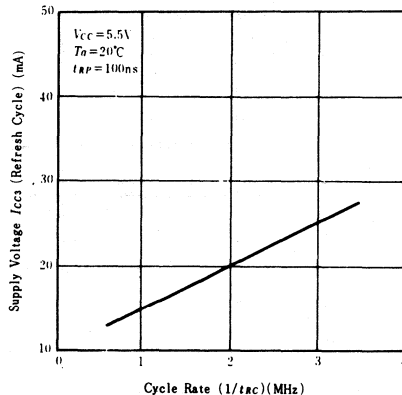

SUPPLY CURRENT vs. SUPPLY VOLTAGE

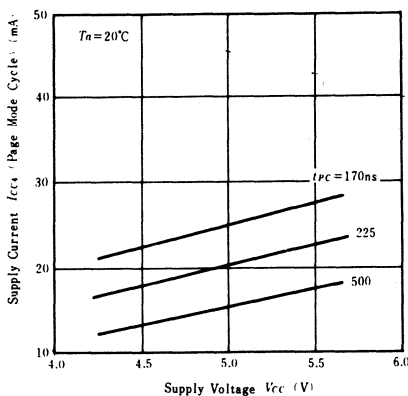

SUPPLY CURRENT vs. AMBIENT TEMPERATURE

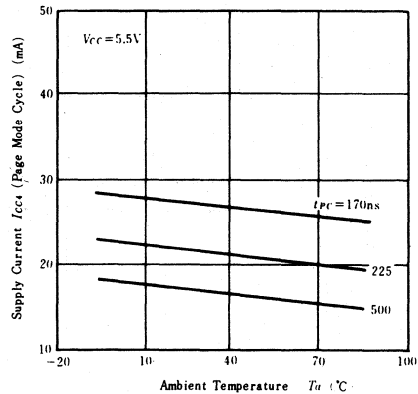

**SUPPLY CURRENT
vs. CYCLE RATE**

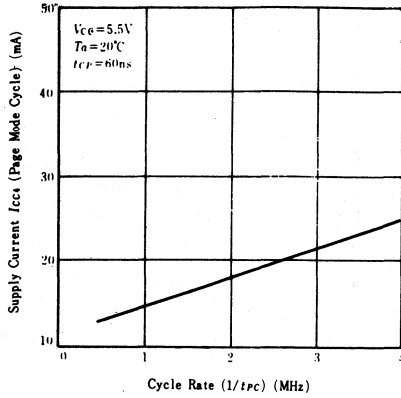

**INPUT LEVEL
vs. SUPPLY VOLTAGE**

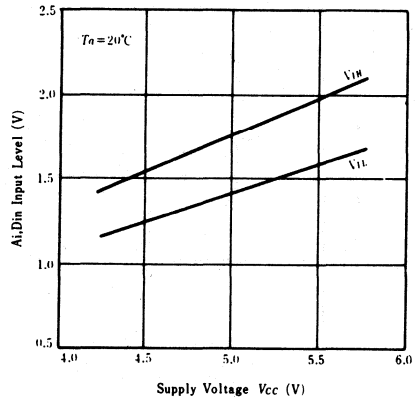

**INPUT LEVEL
vs. AMBIENT TEMPERATURE**

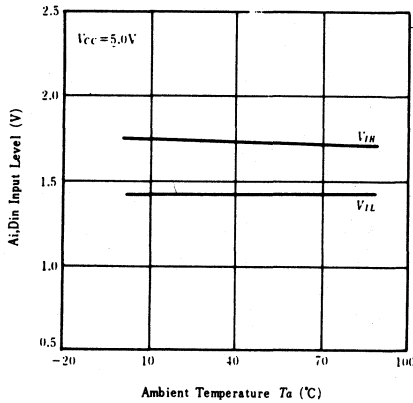

**CLOCK INPUT LEVEL
vs. SUPPLY VOLTAGE**

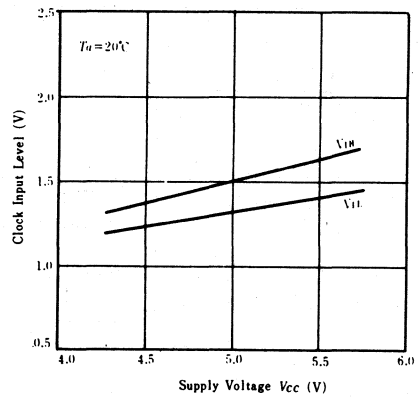

**CLOCK INPUT LEVEL
vs. AMBIENT TEMPERATURE**

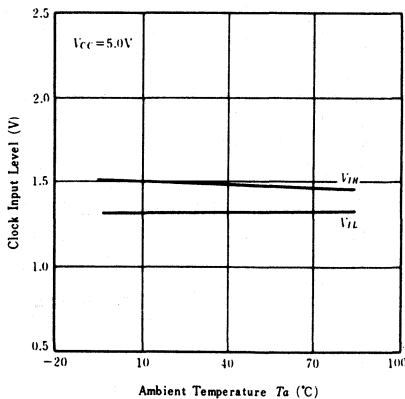

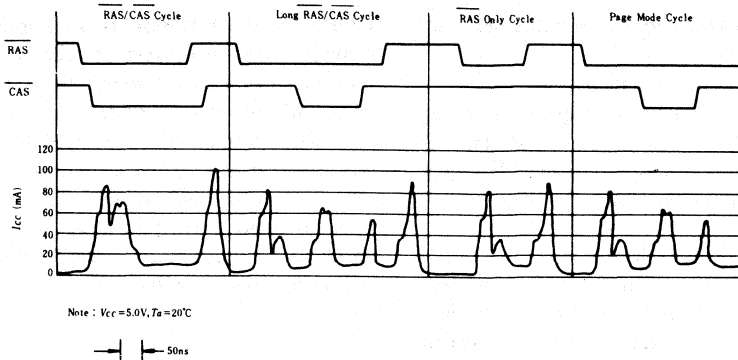

APPLICATION INFORMATION

POWER ON

An initial pause of 500 μs is required after power-up and a minimum of eight (8) initialization cycle, (any combination of cycles containing a RAS clock such as RAS-only refresh) must follow an initial pause.

The V_{CC} current (I_{CC}) requirement of the HM4864 during power on is, however, dependent upon the input levels (\overline{RAS} , \overline{CAS}) and the rise time of V_{CC} , as shown in Fig. 1.

READ CYCLE

A read cycle begins with addresses stable and a negative going transition of \overline{RAS} . The time delay between the stable address and the start of \overline{RAS} -on is controlled by parameter t_{ASR} . Following the time when \overline{RAS} reaches its low level, the row address must be held stable long enough to be captured. This controlling parameter is t_{RAH} . Following this interval, the address can be changed from row address to column address. When the column address is stable, \overline{CAS} can be turned on. The leading edge of \overline{CAS} is controlled by parameter t_{RCD} . The basic limit on the \overline{CAS} leading edge is that \overline{CAS} can not start until the column address is stable, and this is controlled by parameter t_{ASC} . The column address must be held stable long enough to be captured. The controlling parameter is t_{CAH} . Note that t_{RCD} (max) is not an operating limit of the HM4864 though its specification is listed on the data sheets. If \overline{CAS} becomes on later than t_{RCD} (max), the access time from \overline{RAS} will be increased by the time which t_{RCD} exceeds t_{RCD} (max).

Following the time when \overline{CAS} reaches its low level, the data-out pin remains in a high impedance state until a valid data appears. This parameter is t_{CAC} -access time from \overline{CAS} . The access time from \overline{RAS} - t_{RAC} -is the time from \overline{RAS} -on to valid Dout.

The minimum value of t_{RAC} is derived as the sum of t_{RCD} (max) and t_{CAC} .

The selected output data is held valid internally until \overline{CAS} becomes high, and then Dout pin becomes high impedance. This parameter is t_{OFF} .

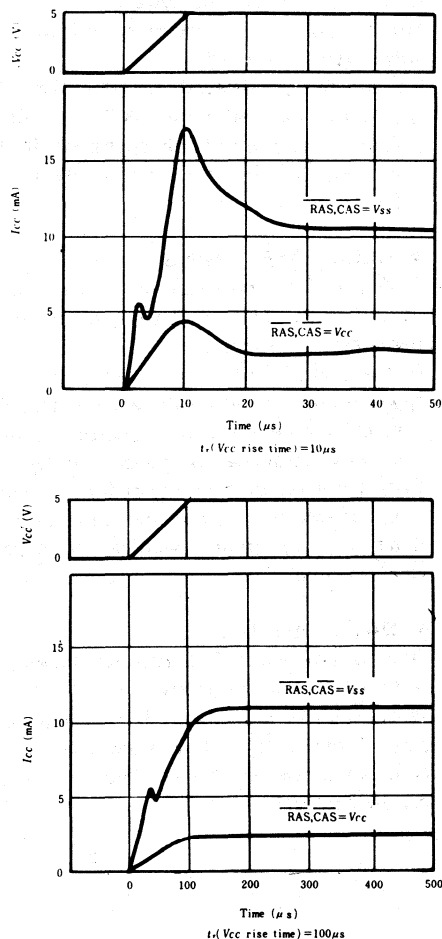

Fig.1 I_{CC} vs. V_{CC} during power up.

● WRITE CYCLE

A write cycle is performed by bringing \overline{WE} low before or during \overline{CAS} -on.

Two different write cycles can be defined as;

Write cycle—Write data are available at the beginning of the \overline{CAS} -on so that the write operation starts at the beginning. In this mode, $Dout$ and \overline{WE} signal times are not in any critical path for determining cycle time.

Following the time when \overline{WE} reaches its low level, \overline{WE} must be held stable long enough to be captured. This \overline{WE} -on pulse duration is called t_{WP} . The time required to capture write data in a latch is called t_{DH} . This cycle is called an "early write".

Read Write cycle—This cycle starts as a read cycle, but as soon as the device specification is met, a write cycle is initiated.

\overline{WE} and Din are delayed until after $Dout$. This cycle is called a "delayed write". A "Read-modify-write" cycle is a variation of this operation. In this mode, Din and \overline{WE} become critical path signals for determining cycle time.

● CLOCK-OFF TIMING

\overline{RAS} and \overline{CAS} must stay on for $Dout$ stabilized to valid data. In the case of \overline{CAS} , this is controlled by parameter t_{CAS} (min).

In the case of \overline{RAS} , this is controlled by parameter t_{CAS} (min). Following the end of \overline{RAS} , \overline{CAS} must stay off long enough to precharge internal circuits. The only parameter of concern is t_{RP} . Normally \overline{CAS} is not required to be off for minimum time of t_{CRP} . However, in a page mode memory operation, there is a t_{CP} (min) specification to control the \overline{CAS} -off time.

● DATA OUTPUT

$Dout$ is three-state TTL compatible with a fan-out of two standard TTL loads.

When \overline{CAS} is high, $Dout$ is in a high impedance state. When \overline{CAS} is low, valid data appears after t_{CAC} at a read cycle, and $Dout$ is not valid as an early-write cycle.

● REFRESH

Refresh of the HM4864 is accomplished by performing a memory cycle at each of the 128 row addresses within each two millisecond time interval. A0 to A6 are refresh address pin compatible with standard 16K RAM (HM4716A, HM4816A). During refresh, either V_{IL} or V_{IH} is permitted for A7. Any cycle in which \overline{RAS} signal occurs refreshes the entire selected row. \overline{RAS} -only refresh results in substantial reduction in operating power. This reduction in power is reflected in the I_{CC3} specification.

● PAGE MODE

Page mode operation allows faster successive memory operations at multiple column locations of the same row address with increased speed.

This is done by strobing the row address into the chip and maintaining \overline{RAS} at a logic low throughout all successive \overline{CAS} memory cycles in which the row address is latched. As the time normally required for strobing a new row address is eliminated, access and cycle times can be decreased and the operating power is reduced. These are specifications.

HM4864CC-2, HM4864CC-3

65536-word × 1-bit Dynamic Random Access Memory

FEATURES

- 18-pin Leadless Chip Carrier
- 150ns access time, 270ns cycle (HM4864CC-2)
200ns access time, 335ns cycle (HM4864CC-3)
- Single power supply of 5V ± 10% with a built-in V_{BB} generator
- Low power: 330mW active, 20mW standby (max)
- The inputs TTL compatible, low capacitance, and protected against static charge.
- Output data controlled by $\overline{\text{CAS}}$ and unlatched at end of cycle to allow two dimensional chip selection and extended page boundary.
- Common I/O capability using "early write" operation
- Read-Modify-Write, $\overline{\text{RAS}}$ -only Refresh, and Page-mode capability
128 refresh cycle

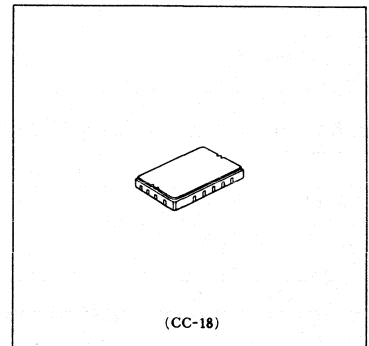

FUNCTIONAL BLOCK DIAGRAM

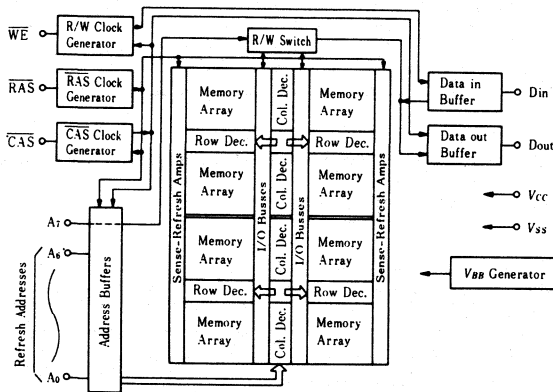

ABSOLUTE MAXIMUM RATINGS

Voltage on any pin relative to V_{SS} -1.0 to +7V
 Operating Temperature, T_a (Ambient) 0 to +70°C
 Storage Temperature (Ambient) -65 to +150°C
 Short-circuit Output Current 50 mA
 Power Dissipation 1 W

PIN ARRANGEMENT

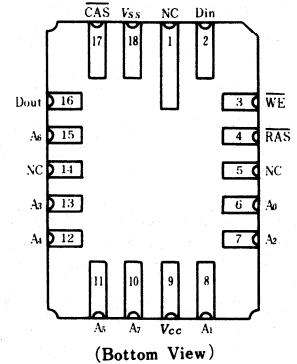

A ₀ -A ₇	Address Inputs
CAS	Column Address Strobe
Din	Data In
Dout	Data Out
RAS	Row Address Strobe
WE	Read/Write Input
V _{CC}	Power (+5V)
V _{SS}	Ground
A ₀ -A ₆	Refresh Address Input

RECOMMENDED DC OPERATING CONDITIONS ($T_a=0$ to $+70^\circ\text{C}$)

Parameter	Symbol	min	typ	max	Unit	Notes
Supply Voltage	V_{CC}	4.5	5.0	5.5	V	1
	V_{SS}	0	0	0	V	
Input High Voltage	V_{IH}	2.4	—	6.5	V	1
Input Low Voltage	V_{IL}	-1.0	—	0.8	V	1

DC ELECTRICAL CHARACTERISTICS ($T_a=0$ to $+70^\circ\text{C}$, $V_{CC}=5\text{V}\pm 10\%$, $V_{SS}=0\text{V}$)

Parameter	Symbol	min	max	Unit	Notes
OPERATING CURRENT					
Average Power Supply Operating Current ($\overline{\text{RAS}}, \overline{\text{CAS}}$ Cycling; $t_{RC}=\text{min.}$)	I_{CC1}	—	60	mA	2, 4
STANDBY CURRENT					
Power Supply Standby Current ($\overline{\text{RAS}}=V_{IH}$, Dout = High Impedance)	I_{CC2}	—	3.5	mA	2
REFRESH CURRENT					
Average Power Supply Current, Refresh Mode ($\overline{\text{RAS}}$ Cycling, $\overline{\text{CAS}}=V_{IH}$; $t_{RC}=\text{min.}$)	I_{CC3}	—	45	mA	2, 4
PAGE MODE CURRENT					
Average Power Supply Current, Page-mode Operation ($\overline{\text{RAS}}=V_{IL}$, $\overline{\text{CAS}}$ Cycling; $t_{PC}=\text{min.}$)	I_{CC4}	—	45	mA	2, 4
INPUT LEAKAGE					
Input Leakage Current, any Input ($V_{in}=0$ to $+6.5\text{V}$, all other pins not under test -0V)	I_{LI}	-10	10	μA	
OUTPUT LEAKAGE					
Output Leakage Current (Dout is disabled, $V_{out}=0$ to $+5.5\text{V}$)	I_{LO}	-10	10	μA	3
OUTPUT LEVELS					
Output High (Logic 1) Voltage ($I_{out}=-5\text{mA}$)	V_{OH}	2.4	V_{CC}	V	
Output Low (Logic 0) Voltage ($I_{out}=4.2\text{mA}$)	V_{OL}	0	0.4	V	

NOTES

- All voltages referenced to V_{SS} .
- I_{CC} depends on output loading condition when the device is selected. I_{CC} max. is specified at the output open condition.
- I_{LO} consists of leakage current only.
- Current depends on cycle rate: maximum current is measured at the fastest cycle rate.

AC ELECTRICAL CHARACTERISTICS

Parameter	Symbol	typ	max	Unit	Notes
Input Capacitance (A_0-A_7, Din)	C_{i1}	—	7	pF	1
Input Capacitance ($\overline{\text{RAS}}, \overline{\text{CAS}}, \overline{\text{WE}}$)	C_{i2}	—	10	pF	1
Output Capacitance (Dout)	C_{out}	—	7	pF	1, 2

NOTES

- Capacitance measured with Boonton Meter or effective capacitance measuring method.
- $\overline{\text{CAS}}=V_{IH}$ to disable DOUT.

ELECTRICAL CHARACTERISTICS AND RECOMMENDED AC OPERATING CONDITIONS ^{1), 2)}

($T_a=0$ to $+70^\circ\text{C}$, $V_{CC}=5\text{V}\pm 10\%$, $V_{SS}=0\text{V}$)

Parameter	Symbol	HM4864CC-2		HM4864CC-3		Unit	Notes
		min	max	min	max		
Random Read or Write Cycle Time	t_{RC}	270	—	335	—	ns	
Read-Write Cycle Time	t_{RWC}	270	—	335	—	ns	
Page Mode Cycle Time	t_{PC}	170	—	225	—	ns	
Access Time from $\overline{\text{RAS}}$	t_{RAC}	—	150	—	200	ns	4, 6
Access Time from $\overline{\text{CAS}}$	t_{CAC}	—	100	—	135	ns	5, 6
Output Buffer Turn-off Delay	t_{OFF}	0	40	0	50	ns	7
Transition Time (Rise and Fall)	t_T	3	35	3	50	ns	3
$\overline{\text{RAS}}$ Precharge Time	t_{RP}	100	—	120	—	ns	
$\overline{\text{RAS}}$ Pulse Width	t_{RAS}	150	10000	200	10000	ns	
$\overline{\text{RAS}}$ Hold Time	t_{RSH}	100	—	135	—	ns	
$\overline{\text{CAS}}$ Pulse Width	t_{CAS}	100	—	135	—	ns	
$\overline{\text{CAS}}$ Hold Time	t_{CSH}	150	—	200	—	ns	
$\overline{\text{RAS}}$ to $\overline{\text{CAS}}$ Delay Time	t_{RCD}	20	50	25	65	ns	8
$\overline{\text{CAS}}$ to $\overline{\text{RAS}}$ Precharge Time	t_{CRP}	-20	—	-20	—	ns	
Row Address Set-up Time	t_{ASR}	0	—	0	—	ns	
Row Address Hold Time	t_{RAH}	20	—	25	—	ns	
Column Address Set-up Time	t_{ASC}	-10	—	-10	—	ns	
Column Address Hold Time	t_{CAH}	45	—	55	—	ns	
Column Address Hold Time referenced to $\overline{\text{RAS}}$	t_{AR}	95	—	120	—	ns	
Read Command Set-up Time	t_{RCS}	0	—	0	—	ns	
Read Command Hold Time	t_{RCH}	0	—	0	—	ns	
Write Command Hold Time	t_{WCH}	45	—	55	—	ns	
Write Command Hold Time referenced to $\overline{\text{RAS}}$	t_{WCR}	95	—	120	—	ns	
Write Command Pulse Width	t_{WP}	45	—	55	—	ns	
Write Command to $\overline{\text{RAS}}$ Lead Time	t_{RWL}	45	—	55	—	ns	
Write Command to $\overline{\text{CAS}}$ Lead Time	t_{CWL}	45	—	55	—	ns	
Data-in Set-up Time	t_{DS}	0	—	0	—	ns	9
Data-in Hold Time	t_{DH}	45	—	55	—	ns	9
Data-in Hold Time referenced to $\overline{\text{RAS}}$	t_{DHR}	95	—	120	—	ns	
$\overline{\text{CAS}}$ Precharge Time (for Page-mode Cycle Only)	t_{CP}	60	—	80	—	ns	
Refresh Period	t_{REF}	—	2	—	2	ms	
Write Command Set-up Time	t_{WCS}	-20	—	-20	—	ns	10
$\overline{\text{CAS}}$ to $\overline{\text{WE}}$ Delay	t_{CWD}	60	—	80	—	ns	10
$\overline{\text{RAS}}$ to $\overline{\text{WE}}$ Delay	t_{RWD}	110	—	145	—	ns	10
$\overline{\text{RAS}}$ Precharge to $\overline{\text{CAS}}$ Hold Time	t_{RPC}	0	—	0	—	ns	

NOTES

- AC measurements assume $t_T = 5\text{ns}$.
- 8 cycles are required after power-on or prolonged periods (greater than 2ms) of $\overline{\text{RAS}}$ inactivity before proper device operation is achieved. Any 8 cycles which perform refresh are adequate for this purpose.
- V_{IH} (min) and V_{IL} (max) are reference levels for measuring timing of input signals. Also, transition times are measured between V_{IH} and V_{IL} .
- Assumes that $t_{RCD} \leq t_{RCD}(\text{max})$. If t_{RCD} is greater than the maximum recommended value shown in this table t_{RAC} exceeds the value shown.
- Assumes that $t_{RCD} \geq t_{RCD}(\text{max})$.
- Measured with a load circuit equivalent to 2TTL loads and 100 pF.
- $t_{OFF}(\text{max})$ defines the time at which the output achieves the open circuit condition and is not referenced to output voltage levels.
- Operation with the $t_{RCD}(\text{max})$ limit insures that

$t_{RAC}(\text{max})$ can be met, $t_{RCD}(\text{max})$ is specified as a reference point only; if t_{RCD} is greater than the specified $t_{RCD}(\text{max})$ limit, then access time is controlled exclusively by t_{CAC} .

- These parameters are reference to $\overline{\text{CAS}}$ leading edge in early write cycles and to $\overline{\text{WE}}$ leading edge in delayed write or read-modify-write cycles.
- t_{WCS} , t_{CWD} and t_{RWD} are not restrictive operating parameters. They are included in the data sheet as electrical characteristics only: if $t_{WCS} \geq t_{WCS}(\text{min})$, the cycle is an early write cycle and the data out pin will remain open circuit (high impedance) throughout the entire cycle; if $t_{CWD} \geq t_{CWD}(\text{min})$ and $t_{RWD} \geq t_{RWD}(\text{min})$ the cycle is a read/write and the data output will contain data read from the selected cell; if neither of the above sets of conditions is satisfied the condition of the data out (at access time) is indeterminate.

■ TIMING WAVEFORMS

● READ CYCLE

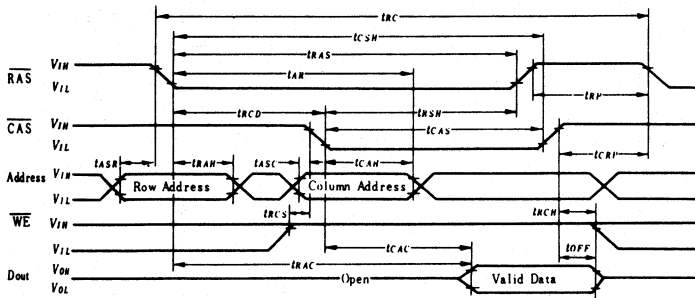

● WRITE CYCLE

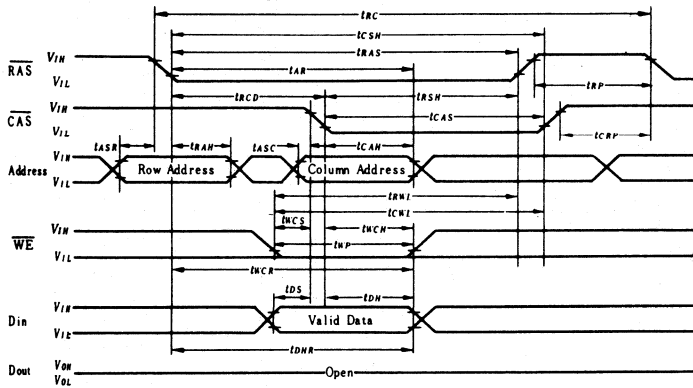

● READ-WRITE/READ-MODIFY-WRITE CYCLE

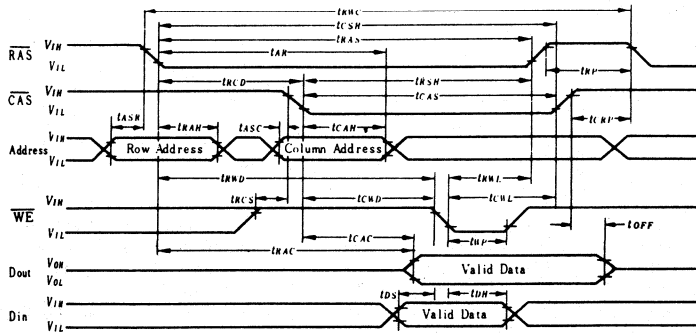

HM4864I-2, HM4864I-3, HM4864K-2, HM4864K-3

Wide Operating Temperature Range

65536-word × 1-bit Dynamic Random Access Memory

The HM4864 is a 65,536-words by 1-bit, MOS random access memory circuit fabricated with HITACHI's double-poly N-channel silicon gate process for high performance and high functional density. The HM4864 uses a single transistor dynamic storage cell and dynamic control circuitry to achieve high speed and low power dissipation.

Multiplexed address inputs permit the HM4864 to be packaged in a standard 16 pin DIP on 0.3 inch centers.

This package size provides high system bit densities and is compatible with widely available automated testing and insertion equipment. System oriented features include single power supply of +5V with $\pm 10\%$ tolerance, direct interfacing capability with high performance logic families such as Schottky TTL, maximum input noise immunity to minimize "false triggering" of the inputs, on-chip address and data registers which eliminate the need for interface registers, and two chip select methods to allow the user to determine the appropriate speed/power characteristics of this memory system. The HM4864 also incorporates several flexible timing/operating modes.

In addition to the usual read, write, and read-modify-write cycles, the HM4864 is capable of delayed write cycles, page-mode operation and RAS-only refresh.

Proper control of the clock inputs ($\overline{\text{RAS}}$, $\overline{\text{CAS}}$, and $\overline{\text{WE}}$) allows common I/O capability, two dimensional chip selection, and extended page boundaries (when operating in page mode).

FEATURES

- Wide Operating Temperature Range

HM4864I-2/-3	-40 ~ +85°C
HM4864K-2/-3	-55 ~ +85°C

- Recognized industry standard 16-pin configuration
- 150ns access time, 270ns cycle time (HM4864I-2, HM4864K-2)
- 200ns access time, 335ns cycle time (HM4864I-3, HM4864K-3)
- Single power supply of +5V $\pm 10\%$ with a built-in V_{BB} generator
- Low Power; 330 mW active. 22 mW standby (max)
- The inputs TTL compatible, low capacitance, and protected against static charge
- Output data controlled by $\overline{\text{CAS}}$ and unlatched at end of cycle to allow two dimensional chip selection and extended page boundary
- Common I/O capability using "early write" operation
- Read-Modify-Write, $\overline{\text{RAS}}$ -only refresh, and Page-mode capability
- 128 refresh cycle

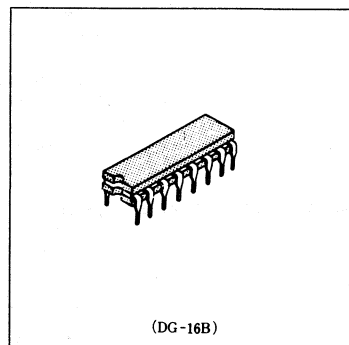

PIN ARRANGEMENT

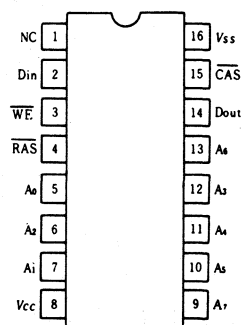

(Top View)

A_0-A_7	Address Inputs
$\overline{\text{CAS}}$	Column Address Strobe
Din	Data In
Dout	Data Out
$\overline{\text{RAS}}$	Row Address Strobe
$\overline{\text{WE}}$	Read/Write Input
V_{CC}	Power (+5V)
V_{SS}	Ground
A_0-A_6	Refresh Address Input

FUNCTIONAL BLOCK DIAGRAM

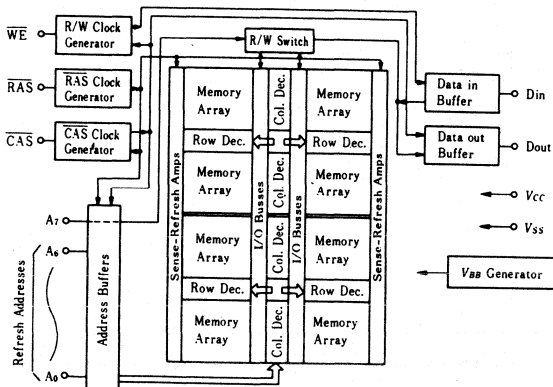

ABSOLUTE MAXIMUM RATINGS

Voltage on any pin relative to V_{SS} -1.0 to +7V
 Operating Temperature, T_a (Ambient) . . . -40 to +85°C (HM4864I Series)
 -55 to +85°C (HM4864K Series)
 Storage Temperature (Ambient) -65 to +150°C
 Short-circuit Output Current . . . 50 mA
 Power Dissipation 1 W

RECOMMENDED DC OPERATING CONDITIONS ($T_a = -40$ to +85°C)*

Parameter	Symbol	min	typ	max	Unit	Notes
Supply Voltage	V_{CC}	4.5	5.0	5.5	V	1
	V_{SS}	0	0	0	V	
Input High Voltage	V_{IH}	2.4	-	6.5	V	1
Input Low Voltage	V_{IL}	-1.0	-	0.8	V	1

*: HM4864K Series; $T_a = -55$ to +85°C

DC ELECTRICAL CHARACTERISTICS ($T_a = -40$ to +85°C, $V_{CC} = 5V \pm 10\%$, $V_{SS} = 0V$)

Parameter	Symbol	min	max	Unit	Notes
OPERATING CURRENT Average Power Supply Operating Current ($\overline{RAS}, \overline{CAS}$ Cycling; $t_{RC} = \text{min.}$)	I_{CC1}	-	60	mA	2, 4
STANDBY CURRENT Power Supply Standby Current ($\overline{RAS} = V_{IH}$, DOUT = High Impedance)	I_{CC2}	-	4	mA	2
REFRESH CURRENT Average Power Supply Current, Refresh Mode (RAS Cycling, $CAS = V_{IH}$; $t_{RC} = \text{min.}$)	I_{CC3}	-	45	mA	2, 4
PAGE MODE CURRENT Average Power Supply Current, Page-mode Operation ($RAS = V_{IL}$, CAS Cycling; $t_{PC} = \text{min.}$)	I_{CC4}	-	45	mA	2, 4
INPUT LEAKAGE Input Leakage Current, any Input ($V_{in} = 0$ to +6.5V, all other pins not under test = 0V)	I_{LI}	-10	10	μA	
OUTPUT LEAKAGE Output Leakage Current (Dout is disabled, $V_{out} = 0$ to +5.5V)	I_{LO}	-10	10	μA	3
OUTPUT LEVELS Output High (Logic 1) Voltage ($I_{out} = -5mA$) Output Low (Logic 0) Voltage ($I_{out} = 4.2mA$)	V_{OH} V_{OL}	2.4 0	V_{CC} 0.4	V V	

NOTES

- All voltages referenced to V_{SS} .
- I_{CC} depends on output loading condition when the device is selected. I_{CC} max. is specified at the output open condition.
- I_{LO} consists of leakage current only.
- Current depends on cycle rate: maximum current is measured at the fastest cycle rate.
- *: HM4864K Series; $T_a = -55$ to +85°C

AC ELECTRICAL CHARACTERISTICS ($V_{CC} = 5V \pm 10\%$, $T_a = 25^\circ C$)

Parameter	Symbol	typ	max	Unit	Notes
Input Capacitance (A_0-A_7, Din)	C_{in1}	-	7	pF	1
Input Capacitance ($\overline{RAS}, \overline{CAS}, \overline{WE}$)	C_{in2}	-	10	pF	1
Output Capacitance (Dout)	C_{out}	-	7	pF	1, 2

NOTES

- Capacitance measured with Boonton Meter or effective capacitance measuring method.
- $CAS = V_{IH}$ to disable D_{OUT} .

■ ELECTRICAL CHARACTERISTICS AND RECOMMENDED AC OPERATING CONDITIONS ^{1), 2)}

($T_a = -40$ to $+85^\circ\text{C}^*$, $V_{CC} = 5\text{V} \pm 10\%$, $V_{SS} = 0\text{V}$)

Parameter	Symbol	HM4864I/K-2		HM4864I/K-3		Unit	Notes
		min	max	min	max		
Random Read or Write Cycle Time	t_{RC}	270	—	335	—	ns	
Read-Write Cycle Time	t_{RWC}	270	—	335	—	ns	
Page Mode Cycle Time	t_{PC}	170	—	225	—	ns	
Access Time from $\overline{\text{RAS}}$	t_{RAC}	—	150	—	200	ns	4, 6
Access Time from $\overline{\text{CAS}}$	t_{CAC}	—	100	—	135	ns	5, 6
Output Buffer Turn-off Delay	t_{OFF}	0	40	0	50	ns	7
Transition Time (Rise and Fall)	t_T	3	35	3	50	ns	3
RAS Precharge Time	t_{RP}	100	—	120	—	ns	
RAS Pulse Width	t_{RAS}	150	10000	200	10000	ns	
RAS Hold Time	t_{RSH}	100	—	135	—	ns	
CAS Pulse Width	t_{CAS}	100	—	135	—	ns	
CAS Hold Time	t_{CSH}	150	—	200	—	ns	
RAS to CAS Delay Time	t_{RCD}	20	50	25	65	ns	8
CAS to RAS Precharge Time	t_{CRP}	-20	—	-20	—	ns	
Row Address Set-up Time	t_{ASR}	0	—	0	—	ns	
Row Address Hold Time	t_{RAH}	20	—	25	—	ns	
Column Address Set-up Time	t_{ASC}	-5	—	-5	—	ns	
Column Address Hold Time	t_{CAH}	45	—	55	—	ns	
Column Address Hold Time referenced to $\overline{\text{RAS}}$	t_{AR}	95	—	120	—	ns	
Read Command Set-up Time	t_{RCS}	0	—	0	—	ns	
Read Command Hold Time	t_{RCH}	0	—	0	—	ns	
Write Command Hold Time	t_{WCH}	45	—	55	—	ns	
Write Command Hold Time referenced to $\overline{\text{RAS}}$	t_{WCR}	95	—	120	—	ns	
Write Command Pulse Width	t_{WP}	45	—	55	—	ns	
Write Command to $\overline{\text{RAS}}$ Lead Time	t_{RWL}	45	—	55	—	ns	
Write Command to CAS Lead Time	t_{CWL}	45	—	55	—	ns	
Data-in Set-up Time	t_{DS}	0	—	0	—	ns	9
Data-in Hold Time	t_{DH}	45	—	55	—	ns	9
Data-in Hold Time referenced to $\overline{\text{RAS}}$	t_{DHR}	95	—	120	—	ns	
CAS Precharge Time (for Page-mode Cycle Only)	t_{CP}	60	—	80	—	ns	
Refresh Period	t_{REF}	—	2	—	2	ms	
Write Command Set-up Time	t_{WCS}	-10	—	-10	—	ns	10
CAS to $\overline{\text{WE}}$ Delay	t_{CWD}	60	—	80	—	ns	10
$\overline{\text{RAS}}$ to $\overline{\text{WE}}$ Delay	t_{RWD}	110	—	145	—	ns	10
RAS Precharge to $\overline{\text{CAS}}$ Hold Time	t_{RPC}	0	—	0	—	ns	

NOTES

- AC measurements assume $t_T = 5\text{ns}$.
- 8 cycles are required after power-on or prolonged periods (greater than 2ms) of $\overline{\text{RAS}}$ inactivity before proper device operation is achieved. Any 8 cycles which perform refresh are adequate for this purpose.
- V_{IH} (min) and V_{IL} (max) are reference levels for measuring timing of input signals. Also, transition times are measured between V_{IH} and V_{IL} .
- Assumes that $t_{RCD} \leq t_{RCD}(\text{max})$. If t_{RCD} is greater than the maximum recommended value shown in this table t_{RAC} exceeds the value shown.
- Assumes that $t_{RCD} \geq t_{RCD}(\text{max})$.
- Measured with a load circuit equivalent to 2TTL loads and 100 pF.
- t_{OFF} (max) defines the time at which the output achieves the open circuit condition and is not referenced to output voltage levels.
- Operation with the $t_{RCD}(\text{max})$ limit insures that $t_{RAC}(\text{max})$ can be met, $t_{RCD}(\text{max})$ is specified as a reference point only; if t_{RCD} is greater than the specified $t_{RCD}(\text{max})$ limit, then access time is controlled exclusively by t_{CAC} .
- These parameters are reference to $\overline{\text{CAS}}$ leading edge in early write cycles and to $\overline{\text{WE}}$ leading edge in delayed write or read-modify-write cycles.
- t_{WCS} , t_{CWD} and t_{RWD} are not restrictive operating parameters. They are included in the data sheet as electrical characteristics only: if $t_{WCS} \geq t_{WCS}(\text{min})$, the cycle is an early write cycle and the data out pin will remain open circuit (high impedance) throughout the entire cycle; if $t_{CWD} \geq t_{CWD}(\text{min})$ and $t_{RWD} \geq t_{RWD}(\text{min})$ the cycle is a read/write and the data output will contain data read from the selected cell; if neither of the above sets of conditions is satisfied the condition of the data out (at access time) is indeterminate.

11. *: HM4864K Series; $T_a = -55$ to $+85^\circ\text{C}$

■ TIMING WAVEFORMS

● READ CYCLE

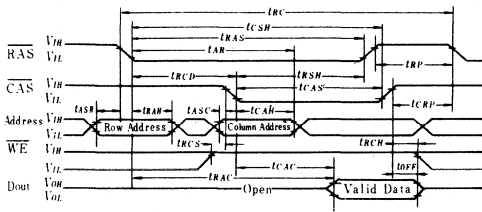

● "RAS-ONLY" REFRESH CYCLE

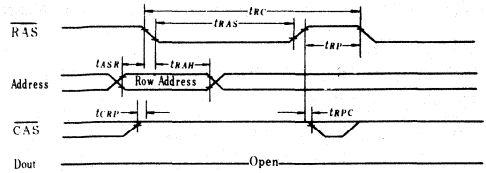

● WRITE CYCLE

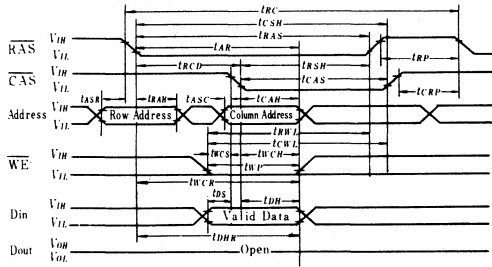

● PAGE MODE READ CYCLE

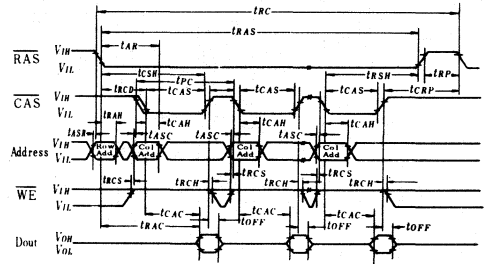

● READ-WRITE/READ-MODIFY-WRITE CYCLE

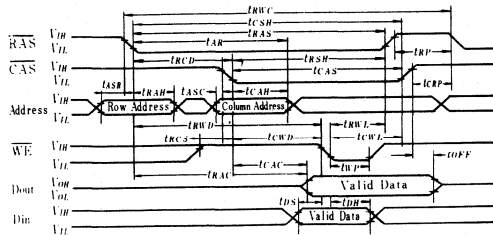

● PAGE MODE WRITE CYCLE

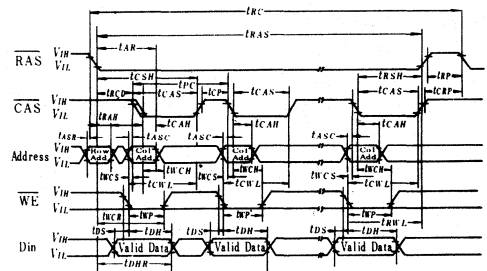

HM4864A-12, HM4864A-15, HM4864A-20, HM4864AP-12, HM4864AP-15, HM4864AP-20

65536-word × 1-bit Dynamic Random Access Memory

FEATURES

- Industry standard 16-Pin DIP (plastic, Cerdip)
- Single 5V ($\pm 10\%$)
- On chip substrate bias generator
- Low Power: 250mW active, 18mW standby
- High speed: Access Time 120ns / 150ns / 200ns
- Common I/O capability using early write operation
- Page mode capability
- Output data controlled by $\overline{\text{CAS}}$
- TTL compatible
- 128 refresh cycles – (2ms)
- Hidden refresh capability

BLOCK DIAGRAM

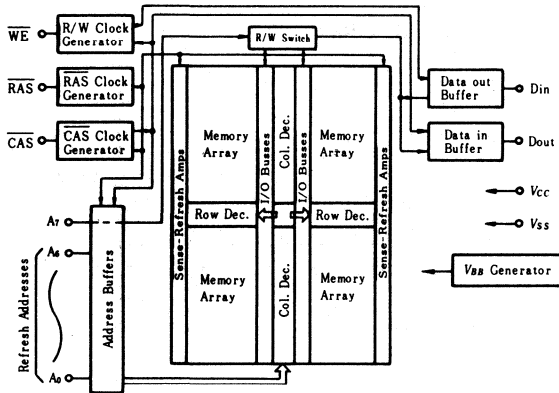

ABSOLUTE MAXIMUM RATINGS

- Voltage on any pin relative to V_{SS} -1V to 7V
- Operating temperature, T_a (Ambient) 0°C to 70°C
- Storage temperature (Cerdip) -65°C to 150°C
- Storage temperature (Plastic) -55°C to 125°C
- Power dissipation 1 W
- Short circuit output current 50 mA

RECOMMENDED DC OPERATING CONDITIONS ($T_a = 0$ to 70°C)

Parameter	Symbol	min.	typ.	max.	Unit	Notes
Supply Voltage	V_{CC}	4.5	5.0	5.5	V	1
Input High Voltage	V_{IH}	2.4	—	6.5	V	1
Input Low Voltage	V_{IL}	-1.0	—	0.8	V	1

Notes : 1. All voltages referenced to V_{SS}

HM4864A-12, HM4864A-15,
HM4864A-20

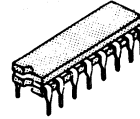

(DG-16B)

HM4864AP-12, HM4864AP-15,
HM4864AP-20

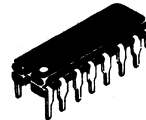

(DP-16)

PIN ARRANGEMENT

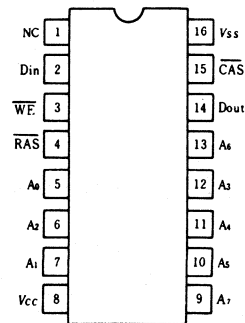

(Top View)

- A0-A7 : Address Inputs
- CAS : Column Address Strobe
- Din : Data In
- Dout : Data Output
- RAS : Row Address Strobe
- WE : Read/Write Input
- V_{CC} : Power (+5V)
- V_{SS} : Ground
- A0-A6 : Refresh Address Inputs

■ DC ELECTRICAL CHARACTERISTICS ($T_a=0$ to 70°C , $V_{CC}=5\text{V}\pm 10\%$, $V_{SS}=0\text{V}$)

Parameter	Symbol	HM4864A/P-12		HM4864A/P-15		HM4864A/P-20		Unit	Notes
		min	max	min	max	min	max		
Operating Current(RAS,CAS Cycling; $t_{RC}=\text{min}$)	I_{CC1}	—	55	—	50	—	44	mA	1,2
Standby Current(RAS= V_{IH} ,Dout=High Impedance)	I_{CC2}	—	3.5	—	3.5	—	3.5	mA	
Refresh Current(RAS Cycling,CAS= V_{IH} , $t_{RC}=\text{min}$)	I_{CC3}	—	42	—	38	—	33	mA	2
Standby Current(RAS= V_{IH} ,Dout Enable)	I_{CC5}	—	5.5	—	5.5	—	5.5	mA	1
Page Mode Current(RAS= V_{IL} ,CAS Cycling; $t_{PC}=\text{min}$)	I_{CC6}	—	38	—	35	—	31	mA	1,2
Input Leakage($0 < V_{in} < 6.5\text{V}$)	I_{LI}	-10	10	-10	10	-10	10	μA	
Output Leakage(Dout is disabled, $0 < V_{out} < 5.5\text{V}$)	I_{LO}	-10	10	-10	10	-10	10	μA	
Output Levels High($I_{out}=-5\text{mA}$)	V_{OH}	2.4	V_{CC}	2.4	V_{CC}	2.4	V_{CC}	V	
Output Levels Low($I_{out}=4.2\text{mA}$)	V_{OL}	0	0.4	0	0.4	0	0.4	V	

Notes) 1. I_{CC} depends on output loading condition when the device is selected. I_{CC} max. is specified at the output open condition.
2. Current depends on cycle rate: maximum current is measured at the fastest cycle rate.

■ CAPACITANCE ($V_{CC}=5\text{V}\pm 10\%$, $T_a=25^\circ\text{C}$)

Parameter	Symbol	typ	max	Unit	Notes	
Input Capacitance	$A_0 \sim A_7, \text{Din}$	C_{in1}	—	5	pF	1
	RAS, CAS, WE	C_{in2}	—	10	pF	1
Output Capacitance	Dout	C_{out}	—	7	pF	1, 2

Notes) 1. Capacitance measured with Boonton Meter or effective capacitance measuring method.
2. CAS= V_{IH} to disable Dout.

■ ELECTRICAL CHARACTERISTICS AND RECOMMENDED AC OPERATING CONDITIONS

($T_a=0$ to 70°C , $V_{CC}=5\text{V}\pm 10\%$, $V_{SS}=0\text{V}$)

Parameter	Symbol	HM4864A-12		HM4864A-15		HM4864A-20		Unit	Notes
		min	max	min	max	min	max		
Access Time From RAS	t_{RAC}	—	120	—	150	—	200	ns	2, 3
Access Time From CAS	t_{CAC}	—	60	—	75	—	100	ns	3, 4
Output Buffer Turn-off Delay	t_{OFF}	—	35	—	40	—	50	ns	5
Transition Time (Rise and Fall)	t_T	3	35	3	35	3	50	ns	6
Random Read or Write Cycle Time	t_{RC}	220	—	260	—	330	—	ns	
RAS Precharge Time	t_{RP}	90	—	100	—	120	—	ns	
RAS Pulse Width	t_{RAS}	120	10000	150	10000	200	10000	ns	
CAS Pulse Width	t_{CAS}	60	10000	75	10000	100	10000	ns	
RAS to CAS Delay Time	t_{RCD}	25	60	25	75	30	100	ns	7
RAS Hold Time	t_{RSH}	60	—	75	—	100	—	ns	
CAS Hold Time	t_{CSH}	120	—	150	—	200	—	ns	
CAS to RAS Precharge Time	t_{CRP}	-10	—	-10	—	-10	—	ns	
Row Address Set-up Time	t_{ASR}	0	—	0	—	0	—	ns	
Row Address Hold Time	t_{RAH}	15	—	15	—	20	—	ns	
Column Address Set-up Time	t_{ASC}	0	—	0	—	0	—	ns	
Column Address Hold Time	t_{CAH}	20	—	25	—	30	—	ns	
Column Address Hold Time Referenced to RAS	t_{AR}	80	—	100	—	130	—	ns	
WE Command Set-up Time	t_{WCS}	0	—	0	—	0	—	ns	8
Write Command Hold Time	t_{WCH}	40	—	45	—	55	—	ns	
Write Command Hold Time Referenced to RAS	t_{WCR}	100	—	120	—	155	—	ns	
Write Command Pulse Width	t_{WP}	40	—	45	—	55	—	ns	
Write Command to RAS Lead Time	t_{RWL}	40	—	45	—	55	—	ns	
Write Command to CAS Lead Time	t_{CWL}	40	—	45	—	55	—	ns	
Data-in Set-up Time	t_{DS}	0	—	0	—	0	—	ns	9
Data-in Hold Time	t_{DH}	40	—	45	—	55	—	ns	9
Data-in Hold Time Referenced to RAS	t_{DHR}	100	—	120	—	155	—	ns	
Read Command Set-up Time	t_{RCS}	0	—	0	—	0	—	ns	
Read Command Hold Time Referenced to CAS	t_{RCH}	0	—	0	—	0	—	ns	
Read Command Hold Time Referenced to RAS	t_{RRH}	10	—	10	—	10	—	ns	
Refresh Period	t_{REF}	—	2	—	2	—	2	ms	
Read-Write Cycle Time	t_{RWC}	245	—	280	—	345	—	ns	
CAS to WE Delay	t_{CWD}	40	—	45	—	55	—	ns	8
RAS to WE Delay	t_{RWD}	100	—	120	—	155	—	ns	
Page Mode Cycle Time	t_{PC}	120	—	145	—	190	—	ns	
CAS Precharge Time (for Page-mode Cycle Only)	t_{CP}	50	—	60	—	80	—	ns	
CAS Precharge Time	t_{CPN}	30	—	35	—	45	—	ns	
RAS Precharge to CAS Hold Time	t_{RPC}	0	—	0	—	0	—	ns	

Notes

1. AC measurements assume $t_T = 5\text{ns}$.
2. Assumes that $t_{RCD} \leq t_{RCD}(\text{max})$. If t_{RCD} is greater than the maximum recommended value shown in this table, t_{RAC} exceeds the value shown.
3. Measured with a load circuit equivalent to 2TTL loads and 100pF.
4. Assumes that $t_{RCD} \geq t_{RCD}(\text{max})$.
5. $t_{OFF}(\text{max})$ defines the time at which the output achieves the open circuit condition and is not reference to output voltage levels.
6. $V_{IH}(\text{min})$ and $V_{IL}(\text{max})$ are reference levels for measuring timing of input signals. Also, transition times are measured between V_{IH} and V_{IL} .
7. Operation with the $t_{RCD}(\text{max})$ limit insures that $t_{RAC}(\text{max})$ can be met, $t_{RCD}(\text{max})$ is specified as a reference point only, if t_{RCD} is greater than the specified $t_{RCD}(\text{max})$ limit, then access time is controlled exclusively by t_{CAC} .
8. t_{WCS} , t_{CWD} and t_{RWD} are not restrictive operating parameters. They are included in the data sheet as electrical characteristics only; if $t_{WCS} \geq t_{WCS}(\text{min})$, the cycle is an early write cycle and the data output pin will remain open circuit (high impedance) throughout the entire cycle; if $t_{CWD} \geq t_{CWD}(\text{min})$ and $t_{RWD} \geq t_{RWD}(\text{min})$ the cycle is a read-write and the data output will contain data read from the selected cell; if neither of the above sets of conditions is satisfied the condition of the data out (at access time) is indeterminate.
9. These parameters are referenced to $\overline{\text{CAS}}$ leading edge in early write cycles and to $\overline{\text{WE}}$ leading edge in delayed write or read-modify-write cycles.
10. An initial pause of 100 μs is required after power-up followed by a minimum of 8 initialization cycles.

■ TIMING WAVEFORMS

● READ CYCLE

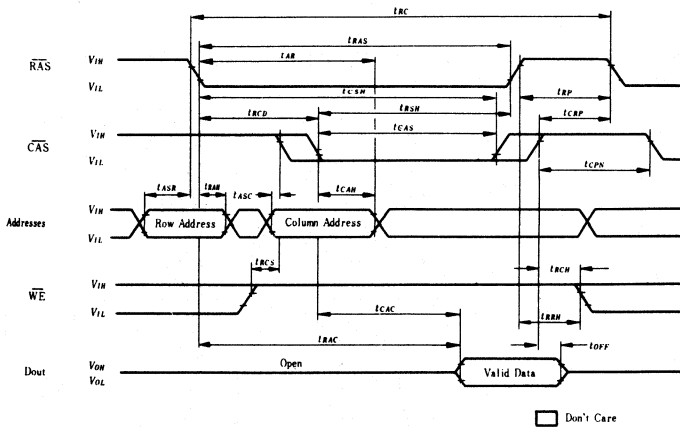

● WRITE CYCLE (EARLY WRITE)

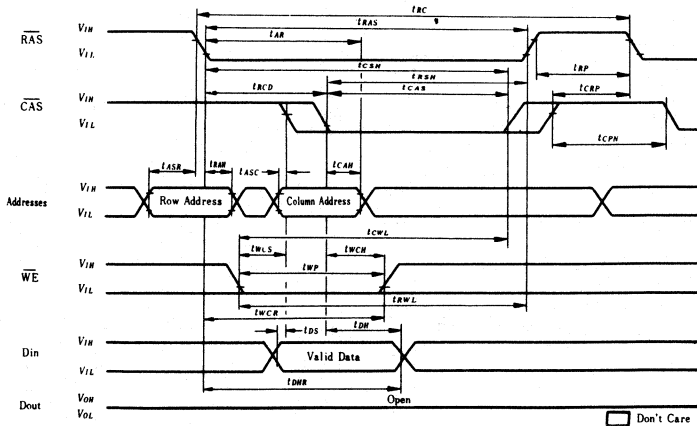

● READ-WRITE/READ-MODIFY-WRITE CYCLE

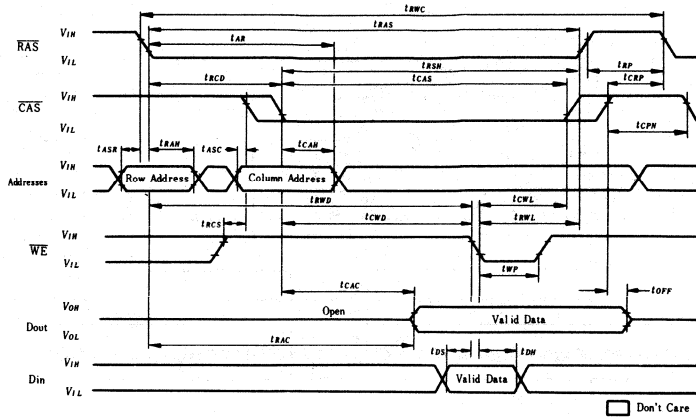

● "RAS-ONLY" REFRESH CYCLE

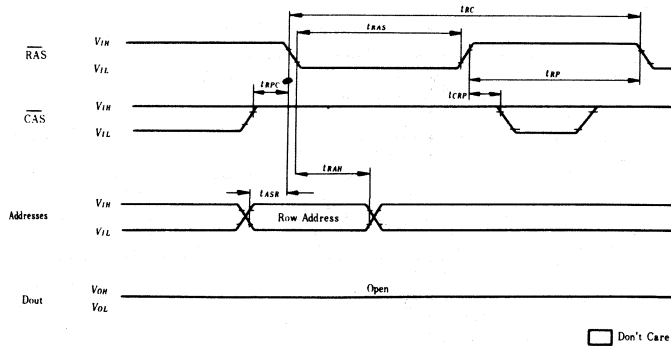

● PAGE MODE READ CYCLE

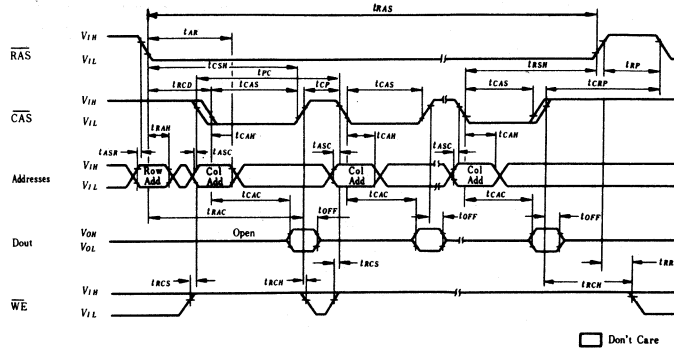

●PAGE MODE WRITE CYCLE

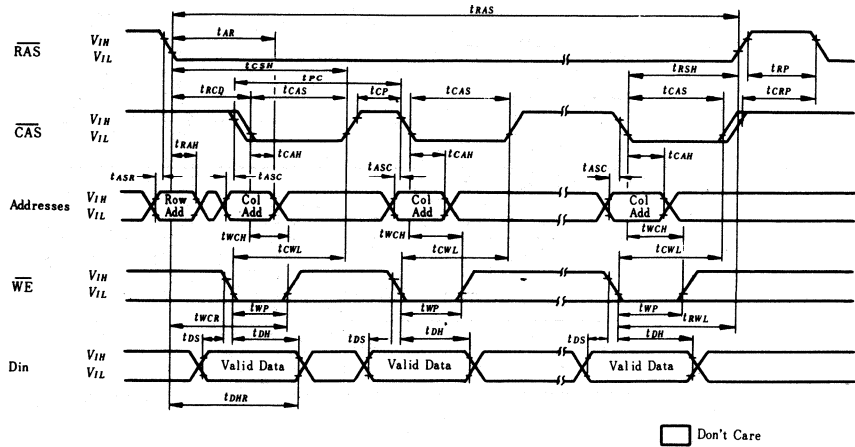

●HIDDEN REFRESH CYCLE

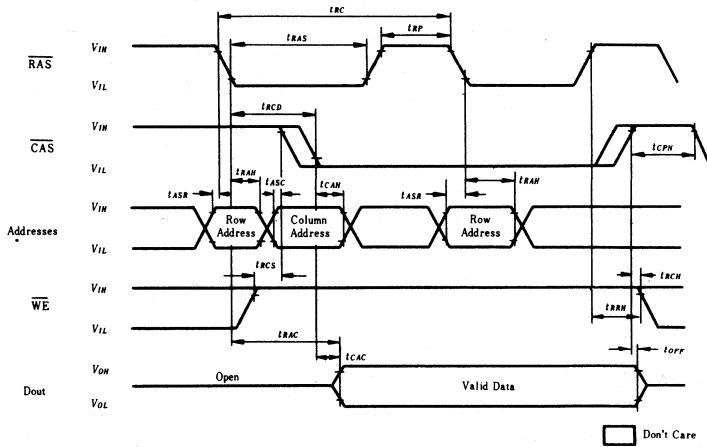

HM4864ACG-12, HM4864ACG-15, HM4864ACG-20

Preliminary

65536-word × 1-bit Dynamic Random Access Memory

FEATURES

- 18-pin Leadless Chip Carrier
- Single 5V ($\pm 10\%$)
- On chip substrate bias generator
- Low Power: 250mW active, 18mW standby
- High speed: Access Time 120/150/200ns (max)
- Common I/O capability using early write operation
- Page mode capability
- Output data controlled by CAS
- TTL compatible
- 128 refresh cycles/2ms
- Hidden refresh capability

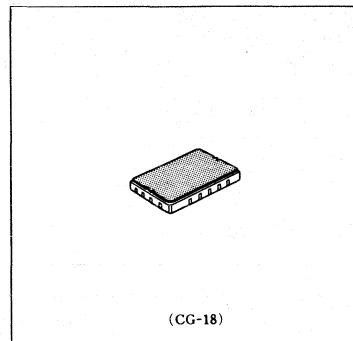

BLOCK DIAGRAM

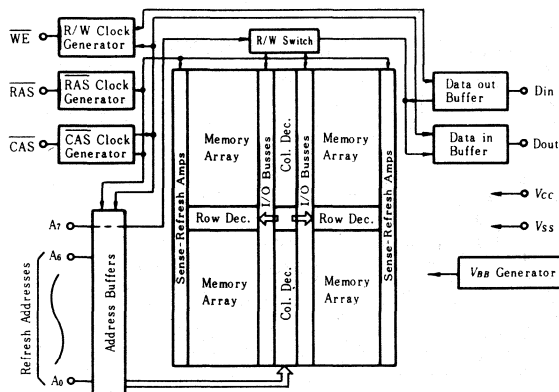

ABSOLUTE MAXIMUM RATINGS

Voltage on any pin relative to V_{SS} -1V to +7V
 Operating temperature, T_a (Ambient) 0°C to $+70^\circ\text{C}$
 Storage temperature -65°C to $+150^\circ\text{C}$
 Power Dissipation 1W
 Short circuit output current 50mA

RECOMMENDED DC OPERATING CONDITIONS ($T_a=0$ to 70°C)

Parameter	Symbol	min.	typ.	max.	Unit	Notes
Supply Voltage	V_{CC}	4.5	5.0	5.5	V	1
Input High Voltage	V_{IH}	2.4	—	6.5	V	1
Input Low Voltage	V_{IL}	-1.0	—	0.8	V	1

Notes: 1. All voltages referenced to V_{SS}

Note) The specifications of this device are subject to change without notice.
 Please contact your nearest Hitachi's Sales Dept. regarding specifications.

PIN ARRANGEMENT

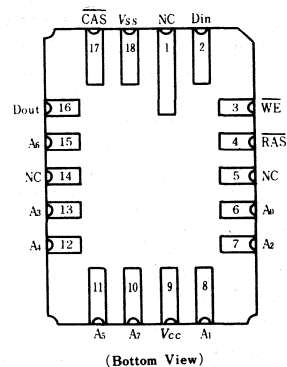

- A0-A7 : Address Inputs
- CAS : Column Address Strobe
- Din : Data In
- Dout : Data Output
- RAS : Row Address Strobe
- WE : Read/Write Input
- V_{CC} : Power (+5V)
- V_{SS} : Ground
- A0-A6 : Refresh Address Inputs

DC ELECTRICAL CHARACTERISTICS ($T_a=0$ to 70°C , $V_{CC}=5\text{V}\pm 10\%$, $V_{SS}=0\text{V}$)

Parameter	Symbol	HM4864ACG-12		HM4864ACG-15		HM4864ACG-20		Unit	Notes
		min	max	min	max	min	max		
Operating Current(RAS,CAS Cycling; $t_{RC}=\text{min}$)	I_{CC1}	—	55	—	50	—	44	mA	1,2
Standby Current(RAS= V_{IH} ,Dout=High Impedance)	I_{CC2}	—	3.5	—	3.5	—	3.5	mA	
Refresh Current(RAS Cycling,CAS= V_{IH} , $t_{RC}=\text{min}$)	I_{CC3}	—	42	—	38	—	33	mA	2
Standby Current(RAS= V_{IH} ,Dout Enable)	I_{CC5}	—	5.5	—	5.5	—	5.5	mA	1
Page Mode Current(RAS= V_{IL} ,CAS Cycling; $t_{PC}=\text{min}$)	I_{CC4}	—	38	—	35	—	31	mA	1,2
Input Leakage($0 < V_{out} < 6.5\text{V}$)	I_{LI}	-10	10	-10	10	-10	10	μA	
Output Leakage(Dout is disabled, $0 < V_{out} < 5.5\text{V}$)	I_{LO}	-10	10	-10	10	-10	10	μA	
Output Levels High($I_{out} = -5\text{mA}$)	V_{OH}	2.4	V_{CC}	2.4	V_{CC}	2.4	V_{CC}	V	
Output Levels Low($I_{out} = 4.2\text{mA}$)	V_{OL}	0	0.4	0	0.4	0	0.4	V	

Notes) 1. I_{CC} depends on output loading condition when the device is selected, I_{CC} max. is specified at the output open condition.
 2. Current depends on cycle rate: maximum current is measured at the fastest cycle rate.

CAPACITANCE ($V_{CC}=5\text{V}\pm 10\%$, $T_a=25^\circ\text{C}$)

Item	Symbol	typ	max	Unit	Notes	
Input Capacitance	$A_0 \sim A_7, \text{Din}$	C_{in1}	—	5	pF	1
	RAS, CAS, WE	C_{in2}	—	10	pF	1
Output Capacitance	Dout	C_{out}	—	7	pF	1, 2

Notes) 1. Capacitance measured with Boonton Meter or effective capacitance measuring method.
 2. CAS = V_{IH} to disable Dout.

ELECTRICAL CHARACTERISTICS AND RECOMMENDED AC OPERATING CONDITIONS

($T_a=0$ to 70°C , $V_{CC}=5\text{V}\pm 10\%$, $V_{SS}=0\text{V}$)

Parameter	Symbol	HM4864ACG-12		HM4864ACG-15		HM4864ACG-20		Unit	Notes
		min	max	min	max	min	max		
Access Time From RAS	t_{RAC}	—	120	—	150	—	200	ns	2, 3
Access Time From CAS	t_{CAC}	—	60	—	75	—	100	ns	3, 4
Output Buffer Turn-off Delay	t_{OFF}	—	35	—	40	—	50	ns	5
Transition Time (Rise and Fall)	t_T	3	35	3	35	3	50	ns	6
Random Read or Write Cycle Time	t_{RC}	220	—	260	—	330	—	ns	
RAS Precharge Time	t_{RP}	90	—	100	—	120	—	ns	
RAS Pulse Width	t_{RAS}	120	10000	150	10000	200	10000	ns	
CAS Pulse Width	t_{CAS}	60	10000	75	10000	100	10000	ns	
RAS to CAS Delay Time	t_{RCD}	25	60	25	75	30	100	ns	7
RAS Hold Time	t_{RSH}	60	—	75	—	100	—	ns	
CAS Hold Time	t_{CSH}	120	—	150	—	200	—	ns	
CAS to RAS Precharge Time	t_{CRP}	-10	—	-10	—	-10	—	ns	
Row Address Set-up Time	t_{ASR}	0	—	0	—	0	—	ns	
Row Address Hold Time	t_{RAH}	15	—	15	—	20	—	ns	
Column Address Set-up Time	t_{ASC}	0	—	0	—	0	—	ns	
Column Address Hold Time	t_{CAH}	20	—	25	—	30	—	ns	
Column Address Hold Time Referenced to RAS	t_{AR}	80	—	100	—	130	—	ns	
WE Command Set-up Time	t_{WCS}	0	—	0	—	0	—	ns	8
Write Command Hold Time	t_{WCH}	40	—	45	—	55	—	ns	
Write Command Hold Time Referenced to RAS	t_{WCR}	100	—	120	—	155	—	ns	
Write Command Pulse Width	t_{WP}	40	—	45	—	55	—	ns	
Write Command to RAS Lead Time	t_{RWL}	40	—	45	—	55	—	ns	
Write Command to CAS Lead Time	t_{CWL}	40	—	45	—	55	—	ns	
Data-in Set-up Time	t_{DS}	0	—	0	—	0	—	ns	9
Data-in Hold Time	t_{DH}	40	—	45	—	55	—	ns	9
Data-in Hold Time Referenced to RAS	t_{DHR}	100	—	120	—	155	—	ns	
Read Command Set-up Time	t_{RCS}	0	—	0	—	0	—	ns	
Read Command Hold Time Referenced to CAS	t_{RCH}	0	—	0	—	0	—	ns	
Read Command Hold Time Referenced to RAS	t_{RRH}	10	—	10	—	10	—	ns	
Refresh Period	t_{REF}	—	2	—	2	—	2	ms	
Read-Write Cycle Time	t_{RWC}	245	—	280	—	345	—	ns	
CAS to WE Delay	t_{CWD}	40	—	45	—	55	—	ns	8
RAS to WE Delay	t_{RWD}	100	—	120	—	155	—	ns	
Page Mode Cycle Time	t_{PC}	120	—	145	—	190	—	ns	
CAS Precharge Time (for Page-mode Cycle Only)	t_{CP}	50	—	60	—	80	—	ns	
CAS Precharge Time	t_{CPN}	30	—	35	—	45	—	ns	
RAS Precharge to CAS Hold Time	t_{RPC}	0	—	0	—	0	—	ns	

● READ-WRITE/READ-MODIFY-WRITE CYCLE

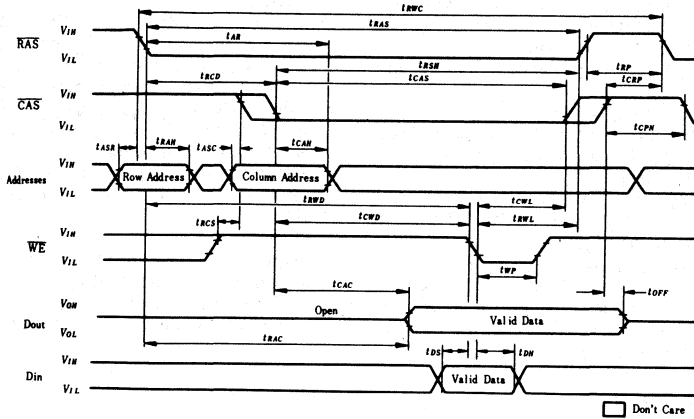

● "RAS-ONLY" REFRESH CYCLE

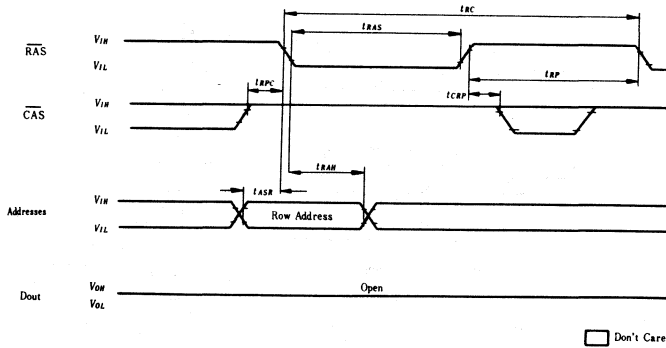

● PAGE MODE READ CYCLE

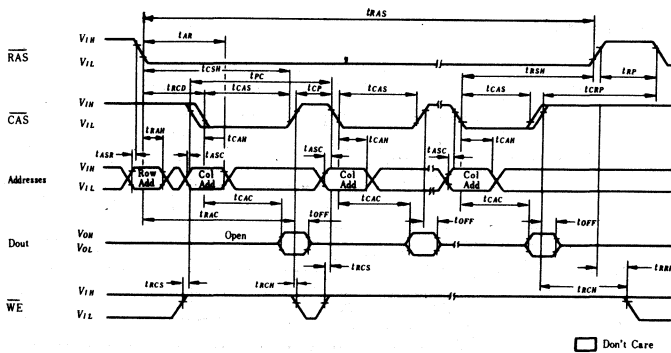

●PAGE MODE WRITE CYCLE

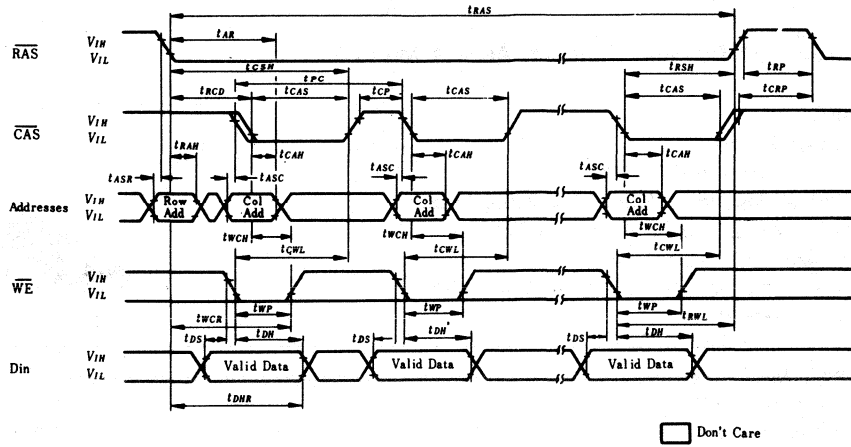

●HIDDEN REFRESH CYCLE

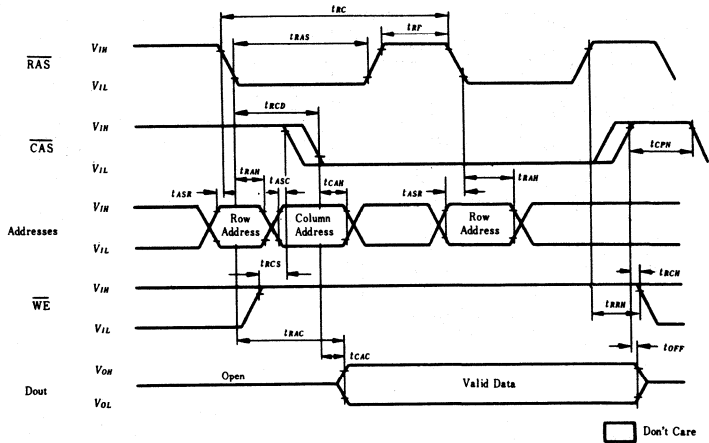

HM4865AP-12, HM4865AP-15 HM4865AP-20

65536-word × 1-bit Dynamic Random Access Memory

■ FEATURES

- Auto Refresh Function
- Single power supply of $5V \pm 10\%$
- High speed: Access time 120ns/150ns/200ns (max.)
- Low Power: 250mW active, 18mW standby
- On chip substrate bias generator
- Common I/O capability using early write operation
- Page mode capability
- Output data controlled by $\overline{\text{CAS}}$
- TTL compatible
- 128 refresh cycles/2ms
- Hidden refresh capability

■ BLOCK DIAGRAM

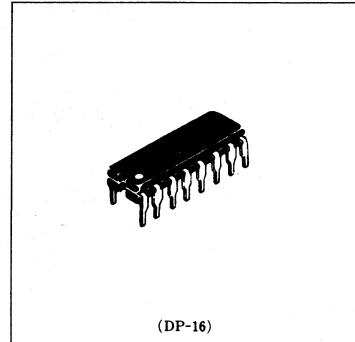
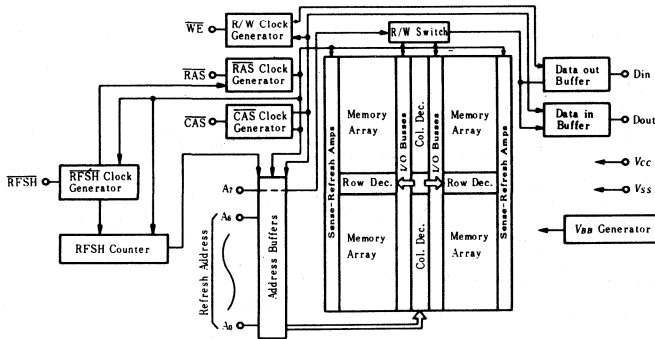

■ PIN ARRANGEMENT

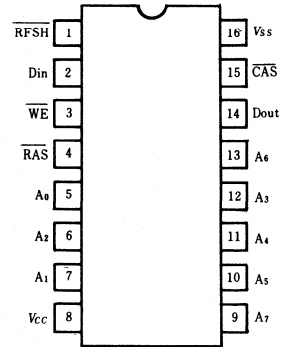

(Top View)

■ ABSOLUTE MAXIMUM RATINGS

Item	Symbol	Value	Unit
Voltage on any pin	V_T	-1.0 to +7.0	V
Supply Voltage	V_{CC}	-1.0 to +7.0	V
Short Circuit Output Current	I_{out}	50	mA
Power Dissipation	P_T	1.0	W
Operating Temperature	T_{opr}	0 to +70	°C
Storage Temperature	T_{stg}	-55 to +125	°C

* with respect to V_{SS}

■ RECOMMENDED DC OPERATING CONDITIONS ($T_a=0$ to +70°C)

Item	Symbol	min	typ	max	Unit
Supply Voltage	V_{CC}	4.5	5.0	5.5	V
	V_{SS}	0	0	0	V
Input Voltage	V_{IH}	2.4	—	6.5	V
	V_{IL}	-1.0	—	0.8	V

Note) All voltages referenced to V_{SS} .

RFSH	Refresh
$A_0 \sim A_7$	Address Inputs
$\overline{\text{CAS}}$	Column Address Strobe
Din	Data In
Dout	Data Out
$\overline{\text{RAS}}$	Row Address Strobe
WE	Read/Write Input
V_{CC}	Power (+5V)
V_{SS}	Ground
$A_0 \sim A_6$	Refresh Address Inputs

■ DC ELECTRICAL CHARACTERISTICS ($T_a=0$ to 70°C , $V_{CC}=5\text{V}\pm 10\%$, $V_{SS}=0\text{V}$)

Parameter	Symbol	HM4865A/P-12		HM4865A/P-15		HM4865A/P-20		Unit	Notes
		min	max	min	max	min	max		
Operating Current(RAS,CAS Cycling; $t_{RC}=\text{min}$)	I_{CC1}	—	55	—	50	—	44	mA	1, 2
Standby Current($\overline{\text{RAS}}=V_{IH}$, Dout=High Impedance)	I_{CC2}	—	3.5	—	3.5	—	3.5	mA	
Refresh Current($\overline{\text{RAS}}$ Cycling, $\overline{\text{CAS}}=V_{IH}$, $t_{RC}=\text{min}$)	I_{CC3}	—	42	—	38	—	33	mA	2
Standby Current($\overline{\text{RAS}}=V_{IH}$, Dout Enable)	I_{CC5}	—	5.5	—	5.5	—	5.5	mA	1
Page Mode Current($\overline{\text{RAS}}=V_{IL}$, CAS Cycling; $t_{PC}=\text{min}$)	I_{CC4}	—	38	—	35	—	31	mA	1, 2
Auto Refresh Current (RFSH=Cycle, $\overline{\text{RAS}}=V_{IH}$)	I_{CC7}	—	44	—	40	—	35	mA	
Input Leakage($0 < V_{in} < 6.5\text{V}$)	I_{LI}	-10	10	-10	10	-10	10	μA	
Output Leakage(Dout is disabled, $0 < V_{out} < 5.5\text{V}$)	I_{LO}	-10	10	-10	10	-10	10	μA	
Output Levels High($I_{out}=-5\text{mA}$)	V_{OH}	2.4	V_{CC}	2.4	V_{CC}	2.4	V_{CC}	V	
Output Levels Low($I_{out}=4.2\text{mA}$)	V_{OL}	0	0.4	0	0.4	0	0.4	V	

Notes) 1. I_{CC} depends on output loading condition when the device is selected, I_{CC} max. is specified at the output open condition.
 2. Current depends on cycle rate: maximum current is measured at the fastest cycle rate.

■ CAPACITANCE ($V_{CC}=5\text{V}\pm 10\%$, $T_a=25^\circ\text{C}$)

Parameter		Symbol	typ	max	Unit	Notes
Input Capacitance	$A_0 \sim A_7, \text{Din}$	C_{in1}	—	5	pF	1
	$\overline{\text{RAS}}, \overline{\text{CAS}}, \overline{\text{WE}}$	C_{in2}	—	10	pF	1
Output Capacitance	Dout	C_{out}	—	7	pF	1, 2

Notes) 1. Capacitance measured with Boonton Meter or effective capacitance measuring method.
 2. $\overline{\text{CAS}}=V_{IH}$ to disable Dout.

■ ELECTRICAL CHARACTERISTICS AND RECOMMENDED AC OPERATING CONDITIONS

($T_a=0$ to 70°C , $V_{CC}=5\text{V}\pm 10\%$, $V_{SS}=0\text{V}$)

■ AC CHARACTERISTICS ($V_{CC}=5\text{V}\pm 10\%$, $V_{SS}=0\text{V}$, $T_a=0$ to $+70^\circ\text{C}$)^{1), 2)}

Item	Symbol	HM4865AP-12		HM4865AP-15		HM4865AP-20		Unit	Notes
		min	max	min	max	min	max		
Random Read or Write Cycle Time	t_{RC}	220	—	260	—	330	—	ns	
Read-Write Cycle Time	t_{RWC}	245	—	280	—	345	—	ns	
Page Mode Cycle Time	t_{PC}	120	—	145	—	190	—	ns	
Access Time from RAS	t_{RAC}	—	120	—	150	—	200	ns	4, 6
Access Time from CAS	t_{CAC}	—	60	—	75	—	100	ns	5, 6
Output Buffer Turn-off Delay	t_{OFF}	—	35	—	40	—	50	ns	7
Transition Time(Rise and Fall)	t_T	3	35	3	35	3	50	ns	3
$\overline{\text{RAS}}$ Precharge Time	t_{RP}	90	—	100	—	120	—	ns	
$\overline{\text{RAS}}$ Pulse Width	t_{RAS}	120	10000	150	10000	200	10000	ns	
$\overline{\text{RAS}}$ Hold Time	t_{RSH}	60	—	75	—	100	—	ns	
CAS Pulse Width	t_{CAS}	60	10000	75	10000	100	10000	ns	
CAS Hold Time	t_{CSH}	120	—	150	—	200	—	ns	
RAS to CAS Delay Time	t_{RCD}	25	60	25	75	30	100	ns	8
CAS to RAS Precharge Time	t_{CRP}	-10	—	-10	—	-10	—	ns	
Row Address Set-up Time	t_{ASR}	0	—	0	—	0	—	ns	
Row Address Hold Time	t_{RAH}	15	—	15	—	20	—	ns	
Column Address Set-up Time	t_{ASC}	0	—	0	—	0	—	ns	
Column Address Hold Time	t_{CAH}	20	—	25	—	30	—	ns	
Column Address Hold Time referenced to RAS	t_{AR}	80	—	100	—	130	—	ns	
Read Command Set-up Time	t_{RCS}	0	—	0	—	0	—	ns	
Read Command Hold Time	t_{RCH}	0	—	0	—	0	—	ns	
Write Command Hold Time	t_{WCH}	40	—	45	—	55	—	ns	
Write Command Hold Time referenced to $\overline{\text{RAS}}$	t_{WCR}	100	—	120	—	155	—	ns	
Write Command Pulse Width	t_{WP}	40	—	45	—	55	—	ns	
Write Command to RAS Lead Time	t_{RWL}	40	—	45	—	55	—	ns	

(to be continued)

Item	Symbol	HM4865AP-12		HM4865AP-15		HM4865AP-20		Unit	Notes
		min	max	min	max	min	max		
Write Command to $\overline{\text{CAS}}$ Lead Time	t_{CWL}	40	—	45	—	55	—	ns	
Data-in Set-up Time	t_{DS}	0	—	0	—	0	—	ns	9
Data-in Hold Time	t_{DH}	40	—	45	—	55	—	ns	9
Data-in Hold Time referenced to $\overline{\text{RAS}}$	t_{DHR}	100	—	120	—	155	—	ns	
$\overline{\text{CAS}}$ Precharge Time(for Page-mode Cycle Only)	t_{CP}	50	—	60	—	80	—	ns	
Refresh Period	t_{REF}	—	2	—	2	—	2	ns	
Write Command Set-up Time	t_{WCS}	0	—	0	—	0	—	ns	10
$\overline{\text{CAS}}$ to $\overline{\text{WE}}$ Delay	t_{CWD}	40	—	45	—	55	—	ns	10
$\overline{\text{RAS}}$ to $\overline{\text{WE}}$ Delay	t_{RWD}	100	—	120	—	155	—	ns	
$\overline{\text{RAS}}$ Precharge to $\overline{\text{CAS}}$ Hold Time	t_{RPC}	0	—	0	—	0	—	ns	
Read-modify-write Hold Time	t_{RRH}	10	—	10	—	10	—	ns	
$\overline{\text{CAS}}$ Precharge Time	t_{CPN}	30	—	35	—	45	—	ns	
RFSH Set-up Time	t_{FSR}	90	—	100	—	120	—	ns	
$\overline{\text{RAS}}$ to RFSH Delay Time	t_{RFD}	90	—	100	—	120	—	ns	
RFSH Cycle Time	t_{FC}	220	—	260	—	330	—	ns	
RFSH Pulse Width	t_{FP}	120	5000	150	5000	200	5000	ns	
RFSH Precharge Time	t_{FI}	90	—	100	—	120	—	ns	

- Notes)
1. AC measurements assume $t_T = 5\text{ns}$.
 2. An initial pause of $100\mu\text{s}$ is required after power-up followed by a minimum of 8 initialization of cycles.
 3. $V_{IH}(\text{min})$ and $V_{IL}(\text{max})$ are reference levels for measuring timing of input signals. Also, transition times are measured between V_{IH} and V_{IL} .
 4. Assumes that $t_{RCD} = t_{RCD}(\text{max})$. If t_{RCD} is greater than the maximum recommended value shown in this table, t_{RAC} exceeds the value shown.
 5. Assumes that $t_{RCD} = t_{RCD}(\text{max})$.
 6. Measured with a load circuit equivalent to 2TTL loads and 100pF .
 7. $t_{OFF}(\text{max})$ defines the time at which the output achieves the open circuit condition and is not referenced to output voltage levels.
 8. Operation with the $t_{RCD}(\text{max})$ limit insures that $t_{RAC}(\text{max})$ can be met, $t_{RCD}(\text{max})$ is specified as a reference point only, if t_{RCD} is greater than the specified $t_{RCD}(\text{max})$ limit, then access time is controlled exclusively by t_{CAC} .
 9. These parameters are referenced to $\overline{\text{CAS}}$ leading edge in early write cycles and to $\overline{\text{WRITE}}$ leading edge in delayed write or read-modify-write cycles.
 10. t_{WCS} , t_{CWD} and t_{RWD} are not restrictive operating parameters. They are included in the data sheet as electrical characteristics only; if $t_{WCS} = t_{WCS}(\text{min})$, the cycle is an early write cycle and the data out pin will remain open circuit (high impedance) throughout the entire cycle; if $t_{CWD} = t_{CWD}(\text{min})$ and $t_{RWD}(\text{min})$ the cycle is a read/write and the data output will contain data read from the selected cell; if neither of the above sets of conditions is satisfied the condition of the data out (at access time) is indeterminate.

● READ-MODIFY-WRITE CYCLE

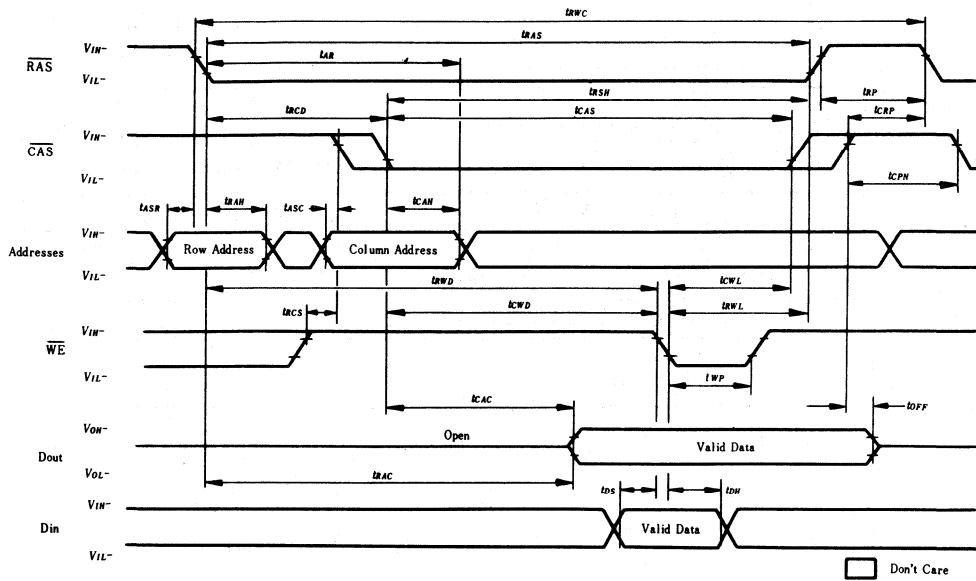

● RAS ONLY REFRESH CYCLE

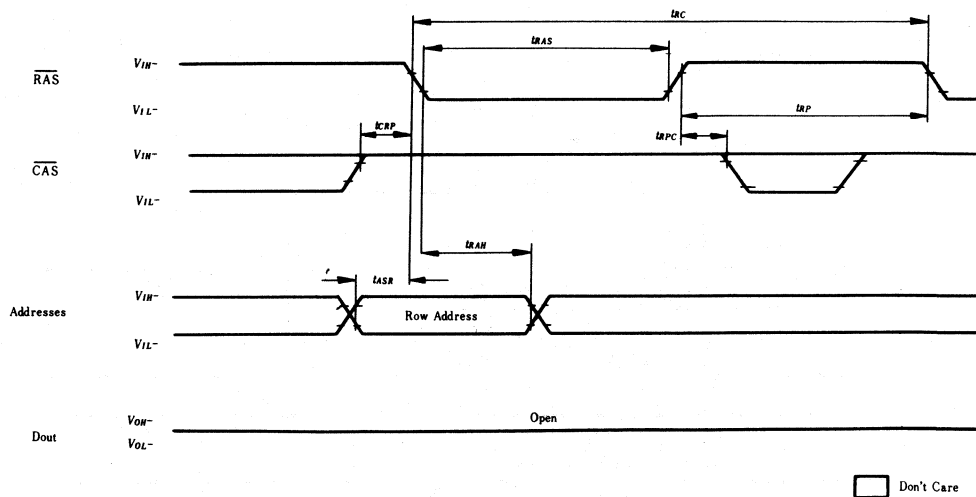

● HIDDEN REFRESH CYCLE

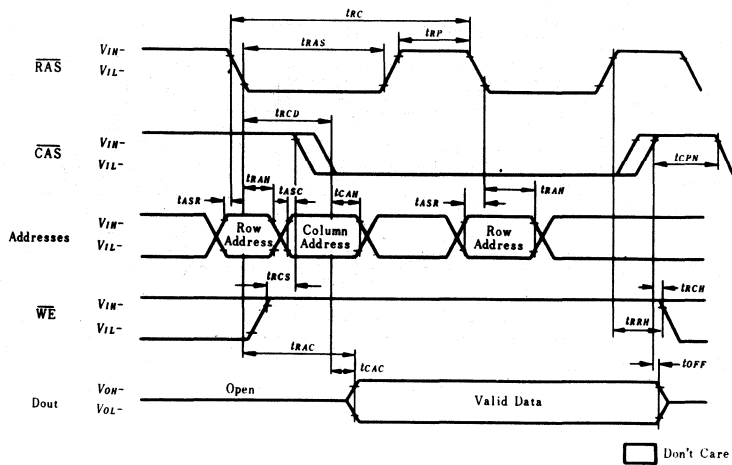

● $\overline{\text{RFSH}}$ (PIN 1) REFRESH CYCLE

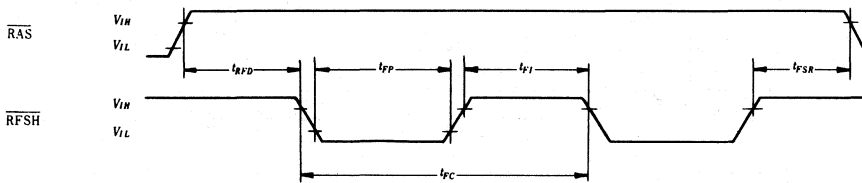

HM50256-12, HM50256-15 — Preliminary HM50256-20

262144-word × 1-bit Dynamic Random Access Memory

FEATURES

- Industry Standard 16-Pin DIP
- Single 5V (±10%)
- On chip substrate bias generator
- Low Power: 350mW active, 23mW standby
- High speed: Access Time 120ns/150ns/200ns(max.)
- Common I/O capability using early write operation
- Page mode capability
- TTL compatible
- 256 refresh cycles/4ns
- 3 variation of refresh . . . $\overline{\text{RAS}}$ only refresh
CAS before RAS refresh
Hidden refresh

BLOCK DIAGRAM

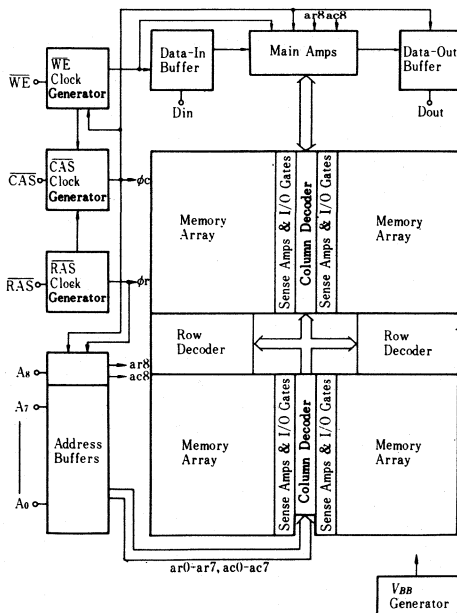

ABSOLUTE MAXIMUM RATINGS

Voltage on any pin relative to V_{SS} -1V to +7V
 Operating temperature, T_a (Ambient) 0°C to +70°C
 Storage temperature -65°C to +150°C
 Power dissipation 1W
 Short circuit output current 50mA

RECOMMENDED DC OPERATING CONDITIONS ($T_a=0$ to +70°C)

Parameter	Symbol	min	typ	max	Unit	Note
Supply Voltage	V_{CC}	4.5	5.0	5.5	V	1
Input High Voltage	V_{IH}	2.4	—	6.5	V	1
Input Low Voltage	V_{IL}	-1.0	—	0.8	V	1

Note) 1. All voltages referenced to V_{SS} .

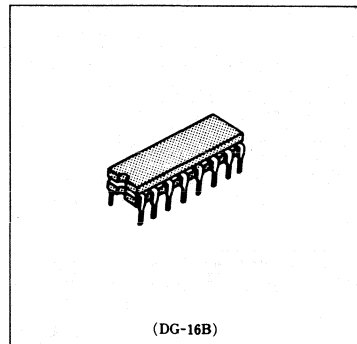

PIN ARRANGEMENT

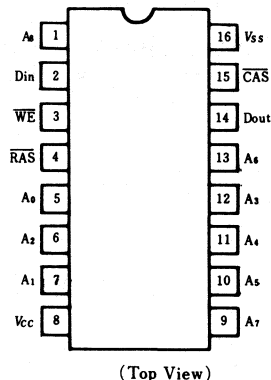

$A_0 \sim A_8$	Address Inputs
CAS	Column Address Strobe
Din	Data In
Dout	Data Out
$\overline{\text{RAS}}$	Row Address Strobe
WE	Read/Write Input
V_{CC}	Power (+5V)
V_{SS}	Ground
$A_0 \sim A_7$	Refresh Address Inputs

Note) The specifications of this device are subject to change without notice. Please contact your nearest Hitachi Sales Dept. regarding specifications.

■ DC ELECTRICAL CHARACTERISTICS ($T_a=0$ to $+70^\circ\text{C}$, $V_{CC}=5\text{V}\pm 10\%$, $V_{SS}=0\text{V}$)

Parameter	Symbol	HM50256-12		HM50256-15		HM50256-20		Unit	Notes
		min	max	min	max	min	max		
Operating Current(RAS, CAS Cycling : $t_{RC}=\text{min}$)	I_{CC1}	—	83	—	70	—	55	mA	1
Standby Current(RAS = V_{IH} , Dout = High Impedance)	I_{CC2}	—	4.5	—	4.5	—	4.5	mA	
Refresh Current($\overline{\text{RAS}}$ only Refresh, $t_{RC}=\text{min}$)	\dot{I}_{CC3}	—	62	—	53	—	42	mA	
Standby Current(RAS = V_{IH} , Dout Enable)	I_{CC5}	—	10	—	10	—	10	mA	1
Refresh Current(CAS before RAS Refresh, $t_{RC}=\text{min}$)	I_{CC6}	—	69	—	58	—	45	mA	
Input leakage($0 < V_{in} < 7\text{V}$)	I_{LI}	-10	10	-10	10	-10	10	μA	
Output leakage($0 < V_{out} < 7\text{V}$)	I_{LO}	-10	10	-10	10	-10	10	μA	
Output levels High($I_{out} = -5\text{mA}$)	V_{OH}	2.4	V_{CC}	2.4	V_{CC}	2.4	V_{CC}	V	
Output levels Low($I_{out} = 4.2\text{mA}$)	V_{OL}	0	0.4	0	0.4	0	0.4	V	

Notes) 1. I_{CC} depends on output loading condition when the device is selected. I_{CC} max is specified at the output open condition.

■ CAPACITANCE ($V_{CC}=5\text{V}\pm 10\%$, $T_a=25^\circ\text{C}$)

Parameter	Symbol	typ	max	Unit	Notes	
						Input Capacitance
	Clocks, Data-out	C_{I2}	—	7	1, 2	

Notes) 1. Capacitance measured with Boonton Meter or effective capacitance measuring method.
2. CAS = V_{IH} to disable Dout.

■ ELECTRICAL CHARACTERISTICS AND RECOMMENDED AC OPERATING CONDITIONS

($T_a=0$ to $+70^\circ\text{C}$, $V_{CC}=5\text{V}\pm 10\%$, $V_{SS}=0\text{V}$)

Parameter	Symbol	HM50256-12		HM50256-15		HM50256-20		Unit	Notes
		min	max	min	max	min	max		
Access Time from RAS	t_{RAC}	—	120	—	150	—	200	ns	2, 3
Access Time from CAS	t_{CAC}	—	60	—	75	—	100	ns	3, 4
Output Buffer Turn-off Delay	t_{OFF}	—	30	—	40	—	50	ns	5
Transition Time(Rise and Fall)	t_T	3	50	3	50	3	50	ns	6
Random Read or Write Cycle Time	t_{RC}	220	—	260	—	330	—	ns	
$\overline{\text{RAS}}$ Precharge Time	t_{RP}	90	—	100	—	120	—	ns	
RAS Pulse Width	t_{RAS}	120	10000	150	10000	200	10000	ns	
CAS Pulse Width	t_{CAS}	60	10000	75	10000	100	10000	ns	
RAS to CAS Delay Time	t_{RCD}	25	60	25	75	30	100	ns	7
RAS Hold Time	t_{RSH}	60	—	75	—	100	—	ns	
CAS Hold Time	t_{CSH}	120	—	150	—	200	—	ns	
$\overline{\text{CAS}}$ to $\overline{\text{RAS}}$ Precharge Time	t_{CRP}	10	—	10	—	10	—	ns	
Row Address Set-up Time	t_{ASR}	0	—	0	—	0	—	ns	
Row Address Hold Time	t_{RAH}	15	—	15	—	20	—	ns	
Column Address Set-up Time	t_{ASC}	0	—	0	—	0	—	ns	
Column Address Hold Time	t_{CAH}	20	—	25	—	30	—	ns	
Column Address Hold Time referenced to RAS	t_{AR}	80	—	100	—	130	—	ns	
$\overline{\text{WE}}$ Command Set-up Time	t_{WCS}	0	—	0	—	0	—	ns	8
Write Command Hold Time	t_{WCH}	40	—	45	—	55	—	ns	
Write Command Hold Time referenced to RAS	t_{WCR}	100	—	120	—	155	—	ns	
Write Command Pulse Width	t_{WP}	40	—	45	—	55	—	ns	
Write Command to RAS Lead Time	t_{RWL}	40	—	45	—	55	—	ns	
Write Command to CAS Lead Time	t_{CWL}	40	—	45	—	55	—	ns	
Data-in Set-up Time	t_{DS}	0	—	0	—	0	—	ns	9
Data-in Hold Time	t_{DH}	40	—	45	—	55	—	ns	8, 9
Data-in Hold Time referenced to RAS	t_{DHR}	100	—	120	—	155	—	ns	
Read Command Set-up Time	t_{RCS}	0	—	0	—	0	—	ns	
Read Command Hold Time referenced to CAS	t_{RCH}	0	—	0	—	0	—	ns	
Read Command Hold Time referenced to RAS	t_{RRH}	10	—	10	—	10	—	ns	
Refresh Period	t_{REF}	—	4	—	4	—	4	ms	

(to be continued)

Parameter	Symbol	HM50256-12		HM50256-15		HM50256-20		Unit	Notes
		min	max	min	max	min	max		
Read-Write Cycle Time	t_{RWC}	265	—	310	—	390	—	ns	
CAS to \overline{WE} Delay	t_{CWD}	60	—	75	—	100	—	ns	8
RAS to \overline{WE} Delay	t_{RWD}	120	—	150	—	200	—	ns	
\overline{CAS} Precharge Time	t_{CPN}	50	—	60	—	80	—	ns	
CAS Setup Time	t_{CSR}	10	—	10	—	10	—	ns	
CAS Hold Time (\overline{CAS} before RAS Refresh)	t_{CHR}	120	—	150	—	200	—	ns	
RAS Precharge to \overline{CAS} Hold Time	t_{RPC}	0	—	0	—	0	—	ns	

Notes

- AC measurements assume $t_T = 5ns$.
- Assumes that $t_{RCD} \leq t_{RCD} (max)$. If t_{RCD} is greater than the maximum recommended value shown in this table, t_{RAC} exceeds the value shown.
- Measured with a load circuit equivalent to 2TTL loads and 100pF.
- Assumes that $t_{RCD} \geq t_{RCD} (max)$.
- t_{OFF} (max) defines the time at which the output achieves the open circuit condition and is not reference to output voltage levels.
- V_{IH} (min) and V_{IL} (max) are reference levels for measuring timing of input signals. Also, transition times are measured between V_{IH} and V_{IL} .
- Operation with the t_{RCD} (max) limit insures that t_{RAC} (max) can be met, t_{RCD} (max) is specified as a reference point only, if t_{RCD} is greater than the specified t_{RCD} (max) limit, then access time is controlled exclusively by t_{CAC} .
- t_{WCS} , t_{CWD} and t_{RWD} are not restrictive operating parameters. They are included in the data sheet is electrical characteristics only; if $t_{WCS} \geq t_{WCS} (min)$, the cycle is an early write cycle and the data output pin will remain open circuit (high impedance) throughout the entire cycle; if $t_{CWD} \geq t_{CWD} (min)$ and $t_{RWD} \geq t_{RWD} (min)$ the cycle is a read-write and the data output will contain data read from the selected cell; if neither of the above sets of conditions is satisfied the condition of the data out (at access time) is indeterminate.
- These parameters are referenced to \overline{CAS} leading edge in early write cycles and to \overline{WE} leading edge is delayed write or read-modify-write cycles.
- An initial pause of 100 μs is required after power-up followed by a minimum of 8 initialization cycles.
- Minimum of 8 CAS before RAS refresh cycle is required before using internal refresh counter.

■ TIMING WAVEFORMS

● READ CYCLE

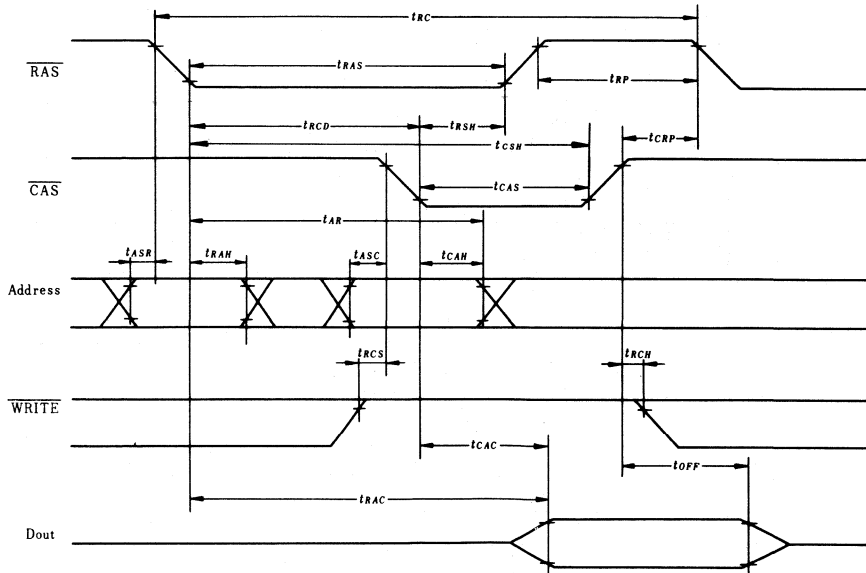

● WRITE CYCLE

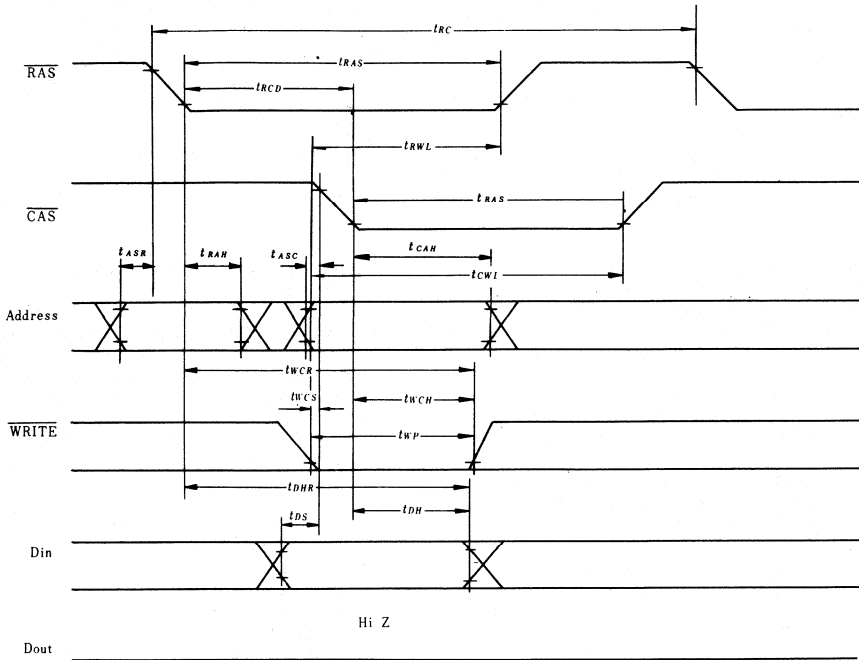

● READ MODIFY WRITE CYCLE

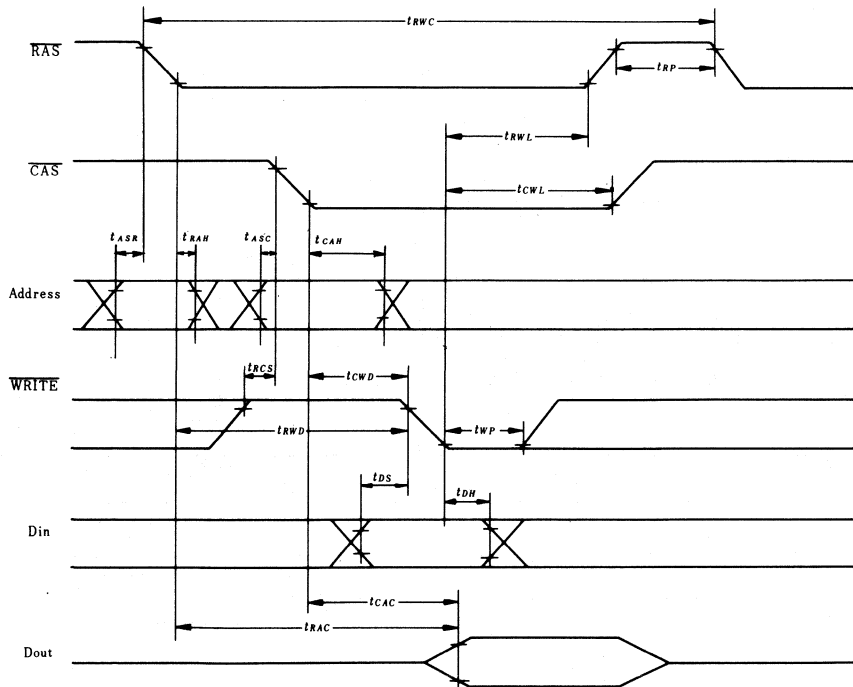

● **RAS ONLY REFRESH CYCLE**

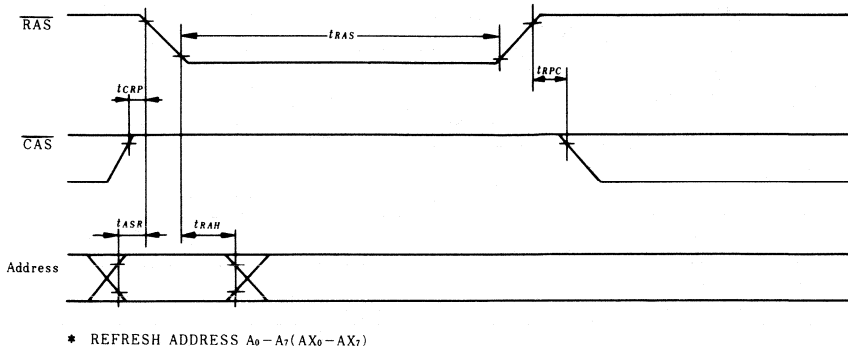

● **HIDDEN REFRESH CYCLE**

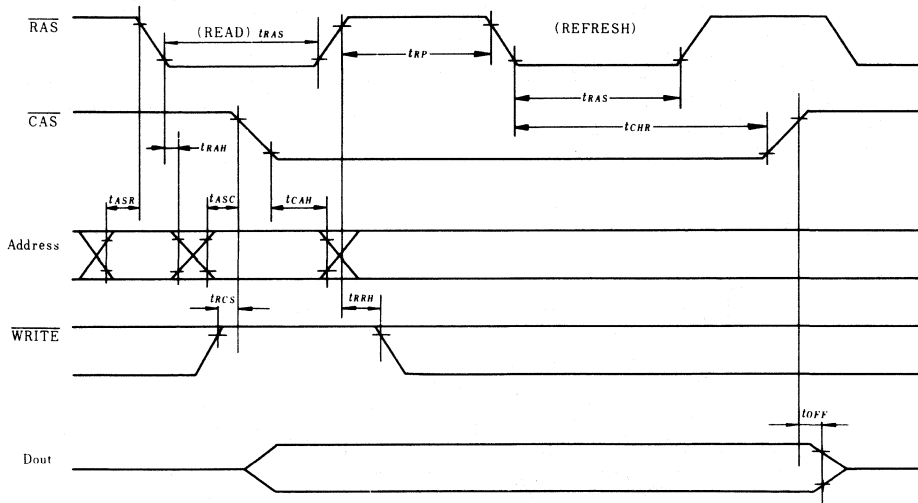

● **CAS BEFORE RAS REFRESH CYCLE**

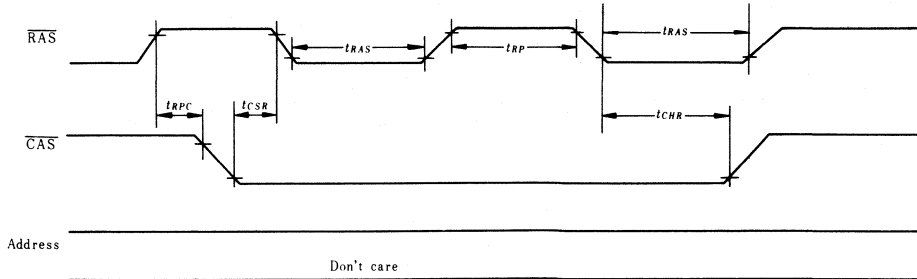

● COUNTER TEST

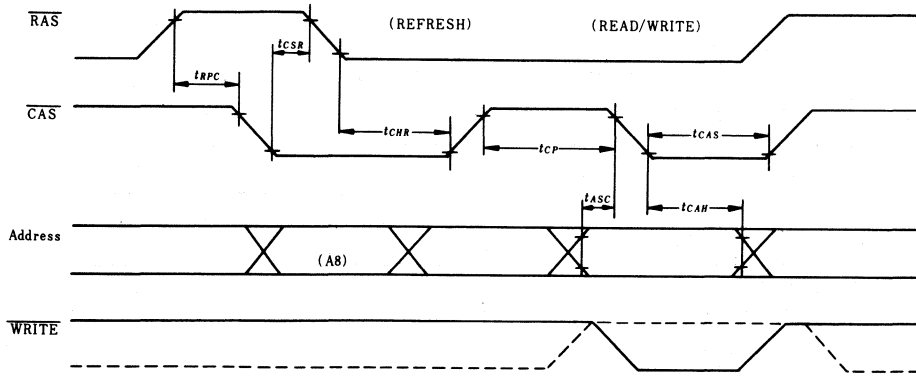

■ PAGE MODE CHARACTERISTICS ($T_a=0$ to $+70^\circ\text{C}$, $V_{CC}=5\text{V}\pm 10\%$, $V_{SS}=0\text{V}$)

Parameter	Symbol	HM50256-12		HM50256-15		HM50256-20		Unit
		min	max	min	max	min	max	
Page Mode Supply Current	I_{CC7}	—	57	—	48	—	37	mA
Page Mode Read or Write Cycle	t_{PC}	120	—	145	—	190	—	ns
CAS Precharge Time, Page Cycle	t_{CP}	50	—	60	—	80	—	ns
Page Mode Read Modify Write Cycle	t_{PCM}	165	—	195	—	250	—	ns

● PAGE MODE READ CYCLE

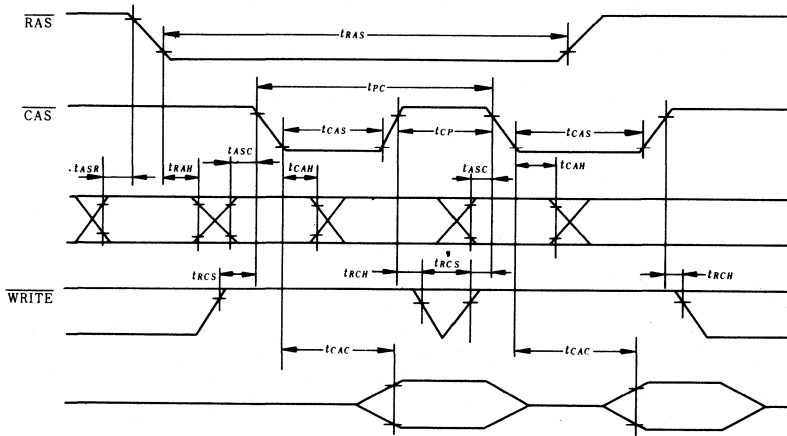

● PAGE MODE WRITE CYCLE

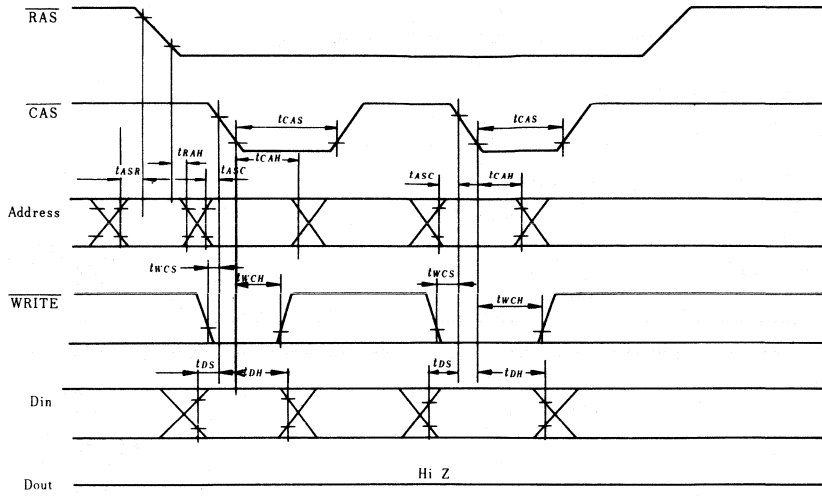

HM50257-12, HM50257-15, — Preliminary HM50257-20

262144-word × 1-bit Dynamic Random Access Memory

■ FEATURES

- Industry standard 16-pin DIP
- Single 5V (±10%)
- On chip substrate bias generator
- Low Power: 350mW active, 20mW standby
- High speed: Access Time 120ns/150ns/200ns (max.)
- Common I/O capability using early write operation
- Nibble mode capability
- Indefinite Dout hold using $\overline{\text{CAS}}$ control
- TTL compatible
- 256 refresh cycles (4ms)
- 3 Variations of refresh; $\overline{\text{RAS}}$ only refresh, $\overline{\text{CAS}}$ before $\overline{\text{RAS}}$ refresh, Hidden refresh

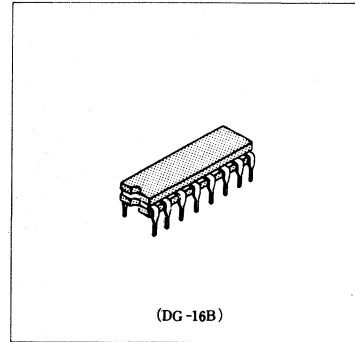

■ BLOCK DIAGRAM

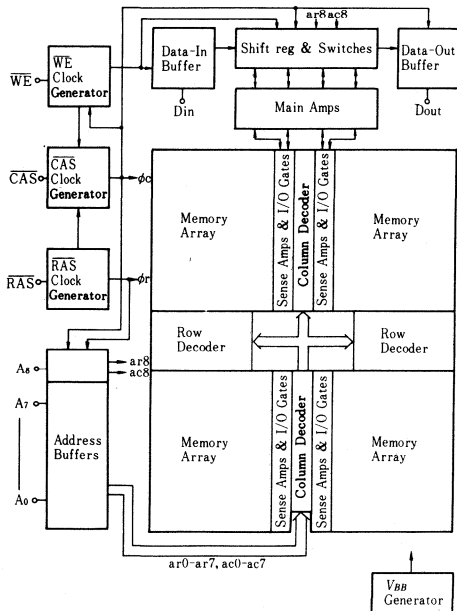

■ PIN ARRANGEMENT

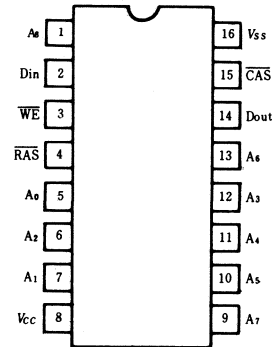

(Top View)

$A_0 \sim A_8$	Address Inputs
$\overline{\text{CAS}}$	Column Address Strobe
Din	Data In
Dout	Data Out
$\overline{\text{RAS}}$	Row Address Strobe
$\overline{\text{WE}}$	Read/Write Input
V_{CC}	Power (+5V)
V_{SS}	Ground
$A_0 \sim A_7$	Refresh Address Inputs

■ ABSOLUTE MAXIMUM RATINGS

- Voltage on any pin relative to V_{SS} -1V to +7V
 Operating temperature, T_a (Ambient) 0°C to +70°C
 Storage temperature -65°C to +150°C
 Power dissipation 1W
 Short circuit output current 50mA

■ RECOMMENDED DC OPERATING CONDITIONS ($T_a=0$ to +70°C)

Parameter	Symbol	min	typ	max	Unit	Note
Supply Voltage	V_{CC}	4.5	5.0	5.5	V	1
Input High Voltage	V_{IH}	2.4	—	6.5	V	1
Input Low Voltage	V_{IL}	-1.0	—	0.8	V	1

Note 1) All voltages referenced to V_{SS} .

Note)

The specifications of this device are subject to change without notice. Please contact your nearest Hitachi Sales Dept. regarding specifications.

■ DC ELECTRICAL CHARACTERISTICS ($T_a=0$ to $+70^\circ\text{C}$, $V_{CC}=5\text{V}\pm 10\%$, $V_{SS}=0\text{V}$)

Parameter	Symbol	HM50257-12		HM50257-15		HM50257-20		Unit	Notes
		min	max	min	max	min	max		
Operating Current (RAS, CAS Cycling: $t_{RC}=\text{min}$)	I_{CC1}	—	83	—	70	—	55	mA	1
Stand by Current (RAS = V_{IH} , Dout = High Impedance)	I_{CC2}	—	4.5	—	4.5	—	4.5	mA	
Refresh Current (RAS only Refresh, $t_{RC}=\text{min}$)	I_{CC3}	—	62	—	53	—	42	mA	
Standby Current (RAS = V_{IH} , Dout Enable)	I_{CC5}	—	10	—	10	—	10	mA	1
Refresh Current (CAS before RAS Refresh, $t_{RC}=\text{min}$)	I_{CC6}	—	69	—	58	—	45	mA	
Input leakage ($0 < V_{in} < 7\text{V}$)	I_{LI}	-10	10	-10	10	-10	10	μA	
Output leakage ($0 < V_{out} < 7\text{V}$)	I_{LO}	-10	10	-10	10	-10	10	μA	
Output levels High ($I_{out} = -5\text{mA}$)	V_{OH}	2.4	V_{CC}	2.4	V_{CC}	2.4	V_{CC}	V	
Output levels Low ($I_{out} = 4.2\text{mA}$)	V_{OL}	0	0.4	0	0.4	0	0.4	V	

Notes) 1. I_{CC} depends on output loading condition when the device is selected I_{CC} max, is specified at the output open condition.

■ CAPACITANCE ($V_{CC}=5\text{V}\pm 10\%$, $T_a=25^\circ\text{C}$)

Parameter	Symbol	typ	max	Unit	Notes
Input Capacitance	Address, Data-In	C_{I1}	—	5	pF
	Clocks, Data-Out	C_{I2}	—	7	

Notes) 1. Capacitance measured with Boonton Meter or effective capacitance measuring method.
2. CAS = V_{IH} to disable Dout.

■ ELECTRICAL CHARACTERISTICS AND RECOMMENDED AC OPERATING CONDITIONS

($T_a=0$ to $+70^\circ\text{C}$, $V_{CC}=5\text{V}\pm 10\%$, $V_{SS}=0\text{V}$)

Parameter	Symbol	HM50257-12		HM50257-15		HM50257-20		Unit	Notes
		min	max	min	max	min	max		
Access Time from RAS	t_{RAC}	—	120	—	150	—	200	ns	2, 3
Access Time from CAS	t_{CAC}	—	60	—	75	—	100	ns	3, 4
Output Buffer Turn-off Delay	t_{OFF}	—	30	—	40	—	50	ns	5
Transition Time (Rise and Fall)	t_T	3	50	3	50	3	50	ns	6
Random Read or Write Cycle Time	t_{RC}	220	—	260	—	330	—	ns	
RAS Precharge Time	t_{RP}	90	—	100	—	120	—	ns	
RAS Pulse Width	t_{RAS}	120	10000	150	10000	200	10000	ns	
RAS Pulse Width	t_{CAS}	60	10000	75	10000	100	10000	ns	
RAS to CAS Delay Time	t_{RCD}	25	60	25	75	30	100	ns	7
RAS Hold Time	t_{RSH}	60	—	75	—	100	—	ns	
CAS Hold Time	t_{CSH}	120	—	150	—	200	—	ns	
CAS to RAS Precharge Time	t_{CRP}	10	—	10	—	10	—	ns	
Row Address Set-up Time	t_{ASR}	0	—	0	—	0	—	ns	
Row Address Hold Time	t_{RAH}	15	—	15	—	20	—	ns	
Column Address Set-up Time	t_{ASC}	0	—	0	—	0	—	ns	
Column Address Hold Time	t_{CAH}	20	—	25	—	30	—	ns	
Column Address Hold Time referenced to RAS	t_{AR}	80	—	100	—	130	—	ns	
WE Command Set-up Time	t_{WCS}	0	—	0	—	0	—	ns	8
Write Command Hold Time	t_{WCH}	40	—	45	—	55	—	ns	
Write Command Hold Time referenced to RAS	t_{WCR}	100	—	120	—	155	—	ns	
Write Command Pulse Width	t_{WP}	40	—	45	—	55	—	ns	
Write Command to RAS Lead Time	t_{RWL}	40	—	45	—	55	—	ns	
Write Command to CAS Lead Time	t_{CWL}	40	—	45	—	55	—	ns	
Data-in Set-up Time	t_{DS}	0	—	0	—	0	—	ns	9
Data-in Hold Time	t_{DH}	40	—	45	—	55	—	ns	8, 9
Data-in Hold Time referenced to RAS	t_{DHR}	100	—	120	—	155	—	ns	
Read Command Set-up Time	t_{RCS}	0	—	0	—	0	—	ns	
Read Command Hold Time referenced to CAS	t_{RCH}	0	—	0	—	0	—	ns	
Read Command Hold Time referenced to RAS	t_{RRH}	10	—	10	—	10	—	ns	
Refresh Period	t_{REF}	—	4	—	4	—	4	ns	

(to be continued)

Parameter	Symbol	HM50257-12		HM50257-15		HM50257-20		Unit	Notes
		min	max	min	max	min	max		
Read-Write Cycle Time	t_{RWC}	265	—	310	—	390	—	ns	
$\overline{\text{CAS}}$ to $\overline{\text{WE}}$ Delay	t_{CWD}	60	—	75	—	100	—	ns	8
$\overline{\text{RAS}}$ to $\overline{\text{WE}}$ Delay	t_{RWD}	120	—	150	—	200	—	ns	
$\overline{\text{CAS}}$ Precharge Time	t_{CPN}	50	—	60	—	80	—	ns	
$\overline{\text{CAS}}$ Setup Time	t_{CSR}	10	—	10	—	10	—	ns	
$\overline{\text{CAS}}$ Hold Time ($\overline{\text{CAS}}$ before $\overline{\text{RAS}}$ Refresh)	t_{CHR}	120	—	150	—	200	—	ns	
$\overline{\text{RAS}}$ Precharge-to $\overline{\text{CAS}}$ Hold Time	t_{RPC}	0	—	0	—	0	—	ns	

Notes

- AC measurements assume $t_T = 5\text{ns}$.
- Assumes that $t_{RCD} \leq t_{RCD}(\text{max})$. If t_{RCD} is greater than the maximum recommended value shown in this table, t_{RAC} exceeds the value shown.
- Measured with a load circuit equivalent to 2TTL loads and 100pF.
- Assumes that $t_{RCD} \geq t_{RCD}(\text{max})$.
- t_{OFF} (max) defines the time at which the output achieves the open circuit condition and is not reference to output voltage levels.
- V_{IH} (min) and V_{IL} (max) are reference levels for measuring timing of input signals. Also, transition times are measured between V_{IH} and V_{IL} .
- Operation with the t_{RCD} (max) limit insures that t_{RAC} (max) can be met, t_{RCD} (max) is specified as a reference point only, if t_{RCD} is greater than the specified t_{RCD} (max) limit, then access time is controlled exclusively by t_{CAC} .
- t_{WCS} , t_{CWD} and t_{RWD} are not restrictive operating parameters. They are included in the data sheet as electrical characteristics only; if $t_{WCS} \geq t_{WCS}(\text{min})$, the cycle is an early write cycle and the data output pin will remain open circuit (high impedance) throughout the entire cycle; if $t_{CWD} \geq t_{CWD}(\text{min})$ and $t_{RWD} \geq t_{RWD}(\text{min})$ the cycle is a read-write and the data output will contain data read from the selected cell; if neither of the above sets of conditions is satisfied the condition of the data out (at access time) is indeterminate.
- These parameters are referenced to $\overline{\text{CAS}}$ leading edge in early write cycles and to $\overline{\text{WE}}$ leading edge is delayed write or read-modify-write cycles.
- An initial pause of 100 μs is required after power-up followed by a minimum of 8 initialization cycles.
- Minimum of 8 $\overline{\text{CAS}}$ before $\overline{\text{RAS}}$ refresh cycle is required before using internal refresh counter.

■ TIMING WAVEFORMS

● READ CYCLE

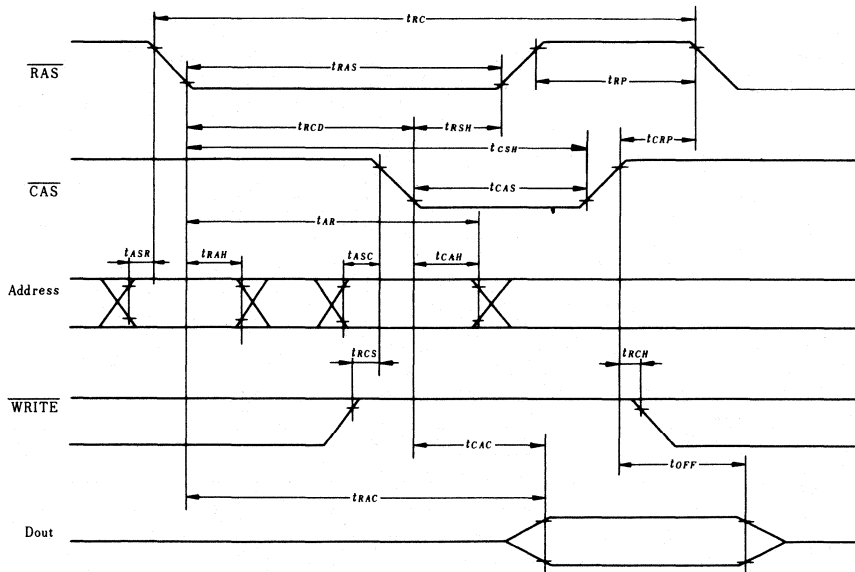

● WRITE CYCLE

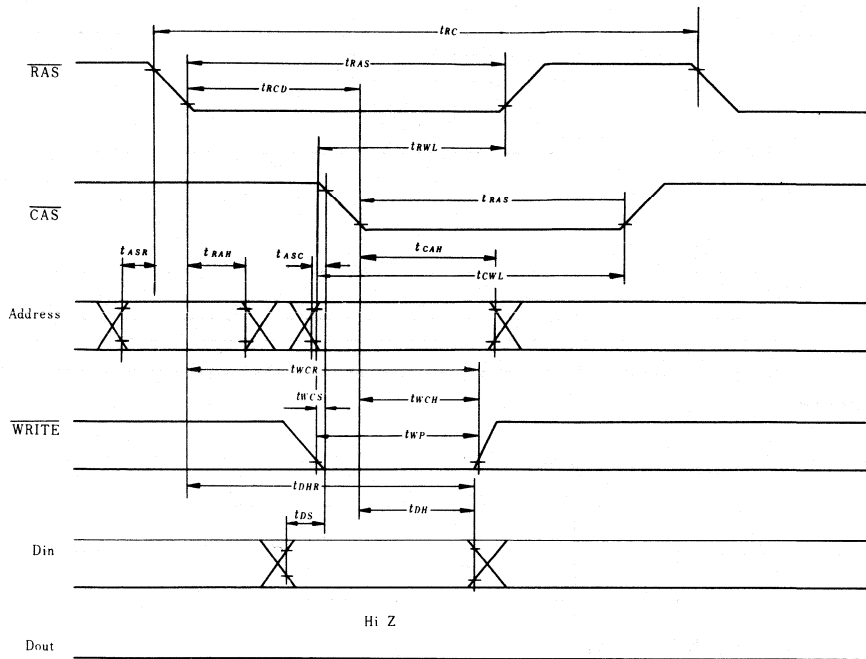

● READ MODIFY WRITE CYCLE

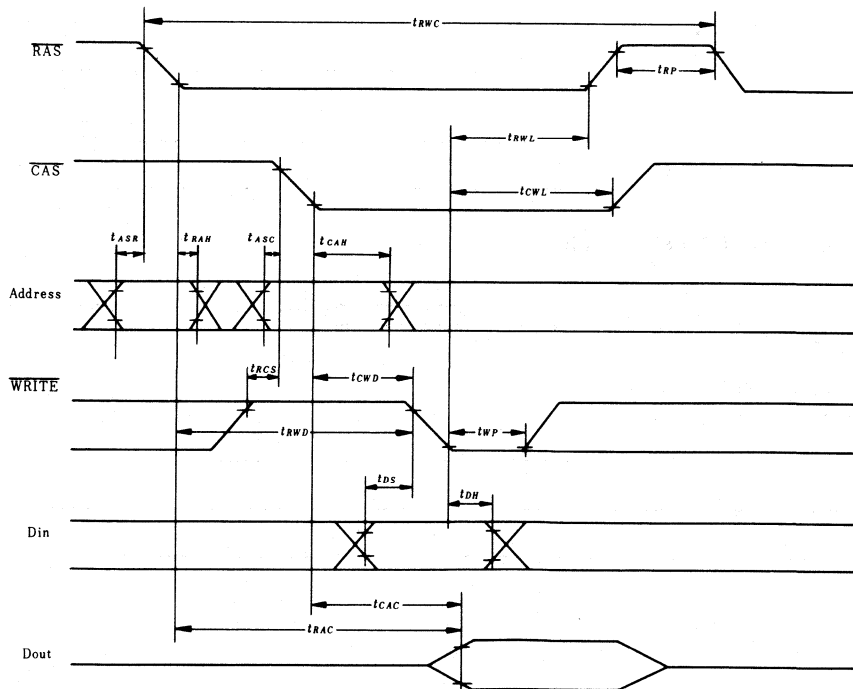

● RAS ONLY REFRESH CYCLE

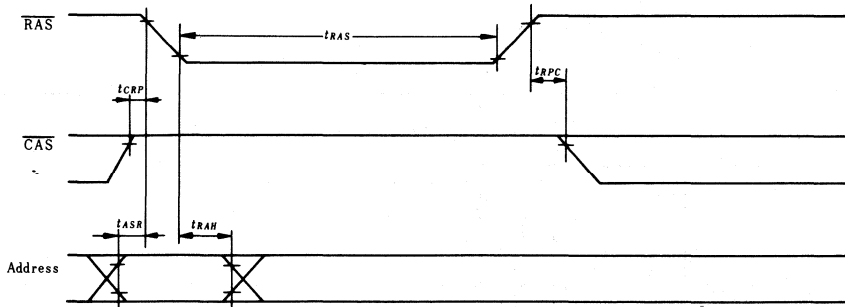

* REFRESH ADDRESS A_0-A_7 (AX_0-AX_7)

● HIDDEN REFRESH CYCLE

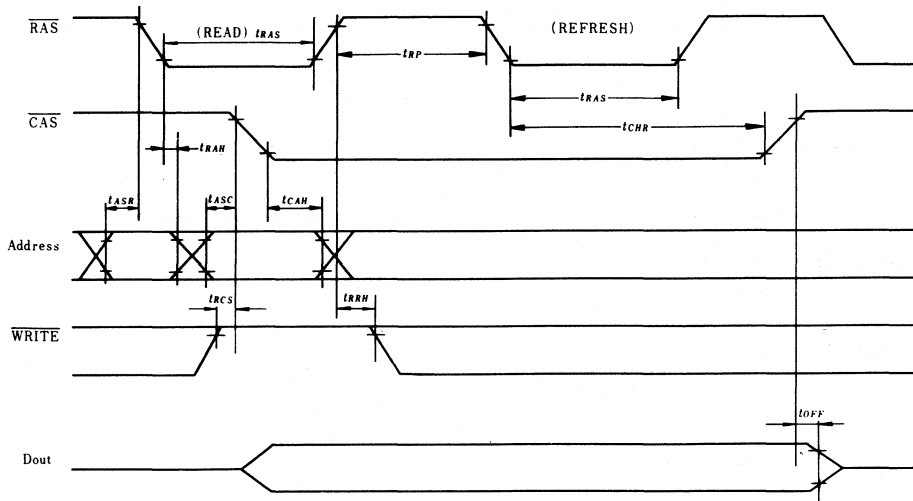

● CAS BEFORE RAS REFRESH CYCLE

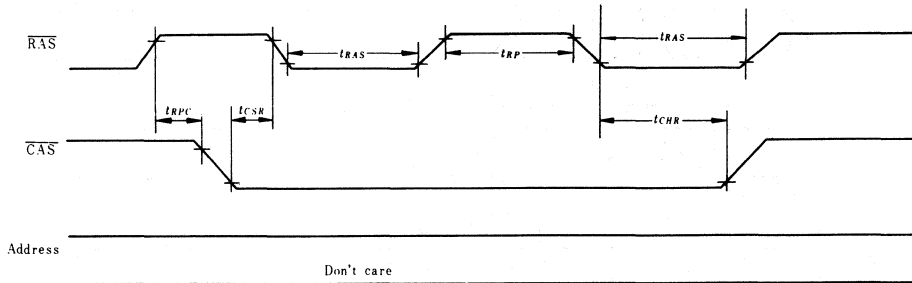

● COUNTER TEST

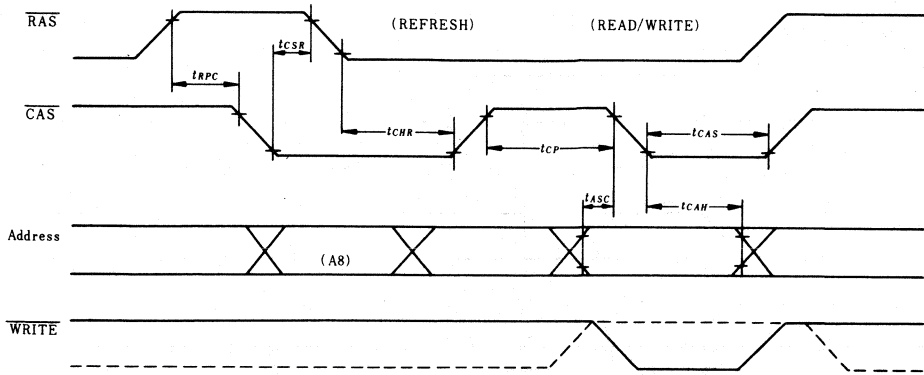

■ NIBBLE MODE CHARACTERISTICS ($T_a=0$ to $+70^\circ\text{C}$, $V_{CC}=5\text{V}\pm 10\%$, $V_{SS}=0\text{V}$)

Parameter	Symbol	HM50257-12		HM50257-15		HM50257-20		Unit
		min	max	min	max	min	max	
Nibble Mode Supply Current	I_{CCB}	—	57	—	48	—	37	mA
Nibble Mode Access Time	t_{NAC}	—	20	—	25	—	35	ns
Nibble Mode $\overline{\text{RAS}}$ Cycle Time	t_{NRC}	390	—	460	—	590	—	ns
Nibble Mode $\overline{\text{RAS}}$ Pulse Width	t_{NRA}	290	—	350	—	460	—	ns
Nibble Mode Cycle Time	t_{NC}	50	—	60	—	80	—	ns
Nibble Mode $\overline{\text{CAS}}$ Precharge Time	t_{NCP}	20	—	25	—	35	—	ns
Nibble Mode $\overline{\text{CAS}}$ Pulse Width	t_{NCA}	20	—	25	—	35	—	ns
Nibble Mode $\overline{\text{RAS}}$ Hold Time	t_{NRSH}	40	—	45	—	55	—	ns

● NIBBLE MODE READ CYCLE

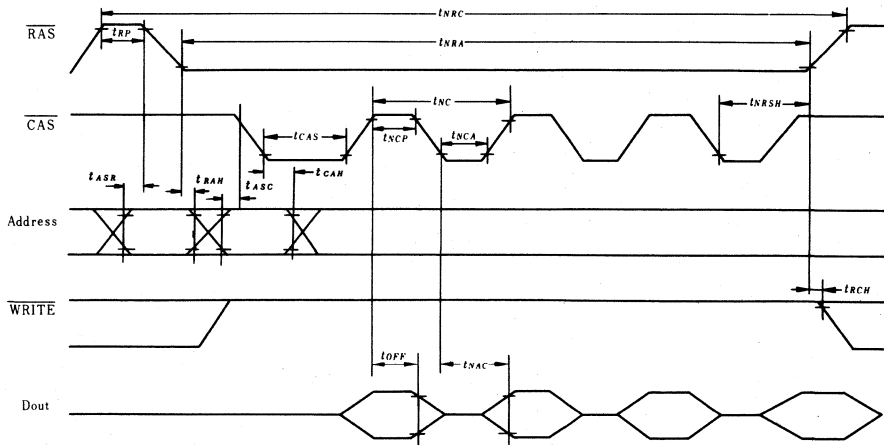

● NIBBLE MODE WRITE CYCLE

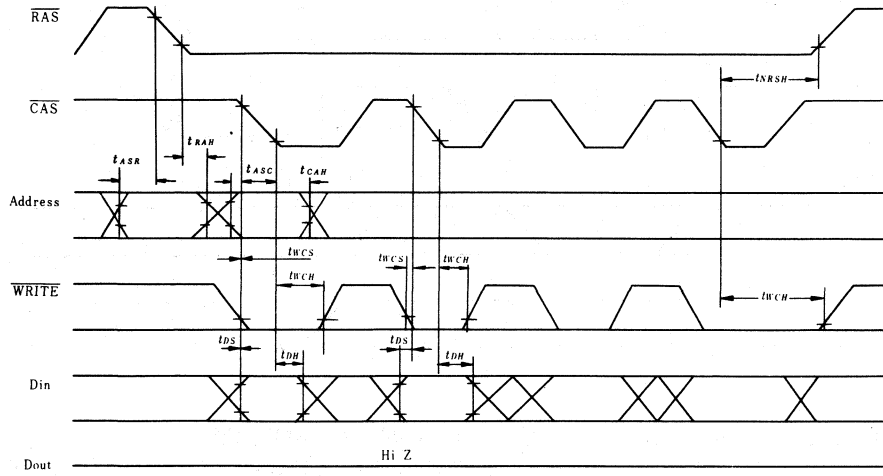

MOS MASK ROM

HN61364P, HN61364FP

8192-word x 8-bit Mask Programmable Read Only Memory

The HN61364P/FP is a mask-programmable, byte-organized memory designed for use in bus-organized systems.

To facilitate use, the device operates from a single power supply, has compatibility with TTL, and requires no clocks or refreshing because of static operation.

The active level of the CS, OE₀ ~ OE₂ inputs and the memory content are defined by the user. The Chip Select input deselected the output and puts the chip in a powerdown mode.

■ FEATURES

- Fully Static Operation
- Automatic Power Down
- Single +5V Power Supply
- Three-state Data Output for OR-ties
- Mask Programmable Chip Select and Output Enable
- TTL Compatible
- Maximum Access Time; 250ns
- Low Power Standby and Low Power Operation; Standby 5μW (typ), Operation 50mW (typ)
- Pin Compatible with EPROM

■ BLOCK DIAGRAM

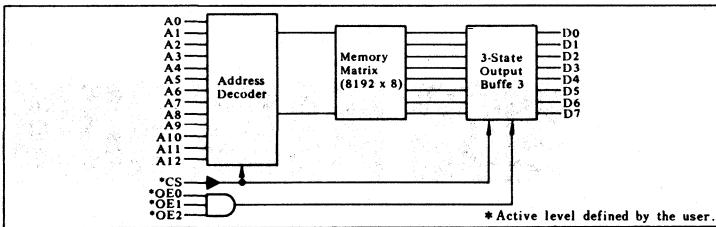

■ ABSOLUTE MAXIMUM RATINGS

Item	Symbol	Value	Unit
Supply Voltage*	V_{CC}	-0.3 to +7.0	V
Input Voltage*	V_{in}	-0.3 to +7.0	V
Operating Temperature	T_{opr}	-20 to +75	°C
Storage Temperature	T_{stg}	-55 to +125	°C
Bias Storage Temperature	T_{bias}	-20 to +85	°C

* with respect to V_{SS}

■ RECOMMENDED DC OPERATING CONDITIONS

Item	Symbol	min	typ	max	Unit
Supply Voltage *	V_{CC}	4.5	5.0	5.5	V
Input Voltage *	V_{IL}	-0.3	-	0.8	V
	V_{IH}	2.2	-	V_{CC}	V
Operating Temperature	T_{opr}	-20	-	75	°C

* with respect to V_{SS}

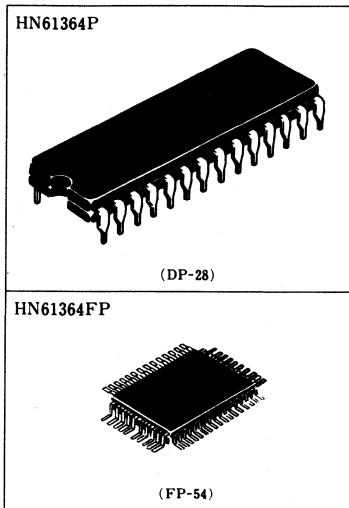

■ PIN ARRANGEMENT

● HN61364P

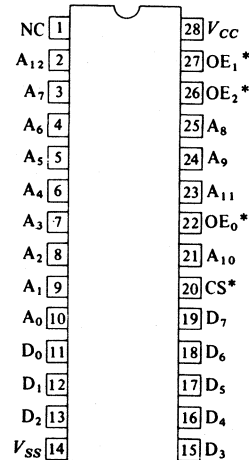

(Top View)

● HN61364FP

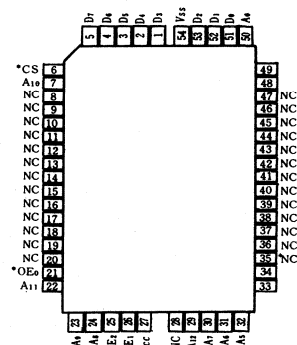

(Top View)

■ ELECTRICAL CHARACTERISTICS ($V_{CC} = 5V \pm 10\%$, $V_{SS} = 0V$, $T_a = -20$ to $+75^\circ C$)

Item	Symbol	Test Condition	min	typ	max	Unit	
Input High-level Voltage	V_{IH}		2.2	—	V_{CC}	V	
Input Low-level Voltage	V_{IL}		-0.3	—	0.8	V	
Output High-level Voltage	V_{OH}	$I_{OH} = -205\mu A$	2.4	—	—	V	
Output Low-level Voltage	V_{OL}	$I_{OL} = 3.2mA$	—	—	0.4	V	
Input Leakage Current	I_{in}	$V_{in} = 0$ to $5.5V$	—	—	2.5	μA	
Output High-level Leakage Current	I_{LOH}	$V_{out} = 2.4V$, $CS = 0.8V$, $\overline{CS} = 2.2V$	—	—	10	μA	
Output Low-level Leakage Current	I_{LOL}	$V_{out} = 0.4V$, $CS = 0.8V$, $\overline{CS} = 2.2V$	—	—	10	μA	
Supply Current	Active	I_{CC}^*	$V_{CC} = 5.5V$, $I_{out} = 0mA$	—	10	25	mA
	Standby	I_{SB}	$V_{CC} = 5.5V$, $\overline{CS} \geq V_{CC} - 0.2V$, $CS \leq 0.2V$	—	1	30	μA
Input Capacitance	C_{in}	$V_{in} = 0V$, $f = 1MHz$, $T_a = 25^\circ C$	—	—	10	pF	
Output Capacitance	C_{out}		—	—	15	pF	

* steady state current

■ RECOMMENDED AC OPERATING CONDITIONS (READ SEQUENCE)

($V_{CC} = 5V \pm 10\%$, $V_{SS} = 0V$, $T_a = -20$ to $+75^\circ C$, $t_r = t_f = 20ns$)

Item	Symbol	min	max	Unit
Read Cycle Time	t_{RC}	250	—	ns
Address Access Time	t_{AA}	—	250	ns
Chip Select Access Time	t_{ACS}	—	250	ns
Chip Selection to Output in Low Z	t_{CLZ}	10	—	ns
Output Enable to Output Valid	t_{OE}	—	100	ns
Output Enable to Output in Low Z	t_{OLZ}	10	—	ns
Chip Deselection to Output in High Z	t_{CHZ}	0	100	ns
Chip Disable to Output in High Z	t_{OHZ}	0	100	ns
Output Hold from Address Change	t_{OH}	10	—	ns

■ TIMING WAVEFORM

● Read Cycle (1)

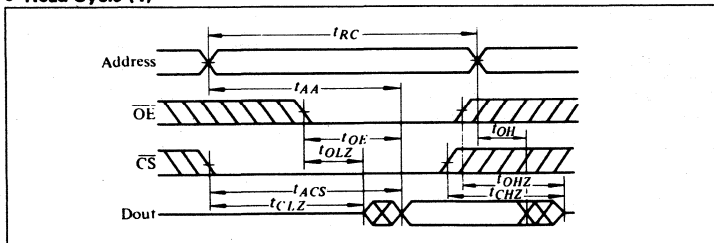

● Read Cycle (2) Notes 1, 3

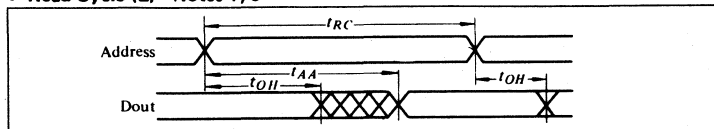

● Read Cycle (3) Notes 2, 3

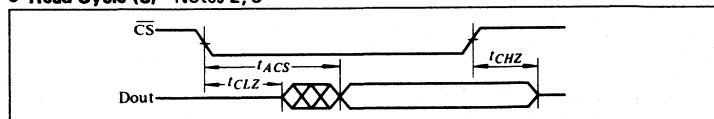

● AC TEST LOAD

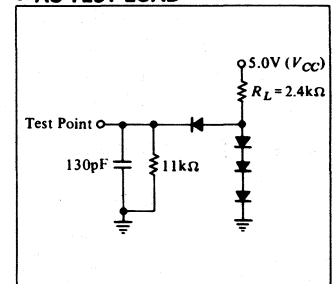

- Notes) 1. $t_r = t_f = 20ns$
 2. C_L includes jig capacitance.
 3. All diodes are 1S2074Ⓢ.

NOTES:

1. Device is continuously selected.
2. Address Valid prior to or coincident with CS transition low.
3. $OE = V_{IL}$

HN61365P

8192-word × 8-bit Mask Programmable Read Only Memory

The HN61365P is a mask-programmable, byte-organized memory designed for use in bus-organized systems.

To facilitate use, the device operates from a single power supply, has compatibility with TTL, and requires no clocks or refreshing because of static operation.

The active level of the CS input and the memory content are defined by the user. The chip select input deselects the output and puts the chip in a power-down mode.

FEATURES

- Fully Static Operation
- Automatic Power Down
- Single +5 Volt Power Supply
- Three-State Data Output for OR-Ties
- Mask Programmable Chip Select
- TTL Compatible
- Maximum Access Time; 250ns
- Low Power Standby and Low Power Operation; Standby 5μW (typ.), Operation 50mW (typ.)
- Pin Compatible with EPROM

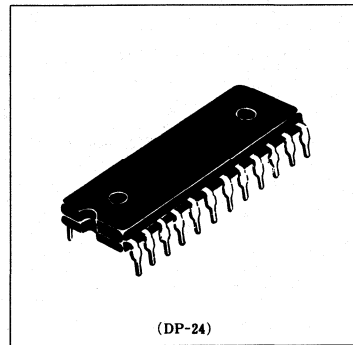

(DP-24)

PIN ARRANGEMENT

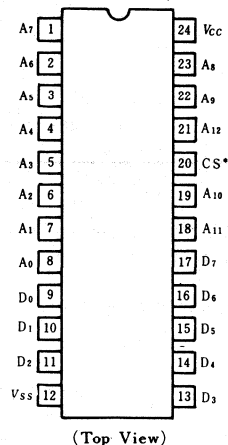

BLOCK DIAGRAM

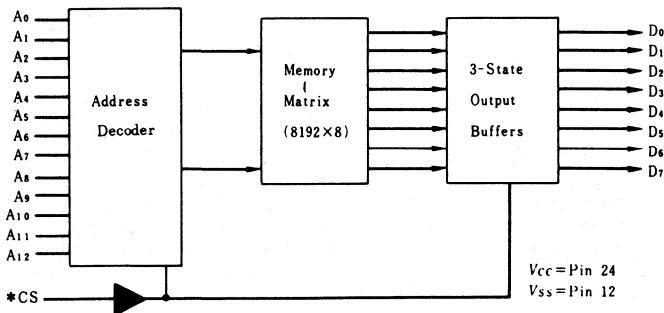

* Active level defined by the user.

ABSOLUTE MAXIMUM RATINGS

Item	Symbol	Value	Unit
Supply Voltage*	V_{CC}	-0.3 to +7.0	V
Input Voltage*	V_{in}	-0.3 to +7.0	V
Operating Temperature	T_{opr}	-20 to +75	°C
Storage Temperature	T_{stg}	-55 to +125	°C
Storage Temperature (under bias)	T_{bias}	-20 to +85	°C

* with respect to V_{SS}

RECOMMENDED DC OPERATING CONDITIONS

Item	Symbol	min	typ	max	Unit
Supply Voltage*	V_{CC}	4.5	5.0	5.5	V
Input Voltage*	V_{IL}	-0.3	—	0.8	V
	V_{IH}	2.2	—	V_{CC}	V
Operating Temperature	T_{opr}	-20	—	75	°C

* With respect to V_{SS}

ELECTRICAL CHARACTERISTICS ($V_{CC}=5V \pm 10\%$, $V_{SS}=0V$, $T_a=-20$ to $+75^\circ C$)

Item	Symbol	Test Conditions	min	typ	max	Unit
Input Voltage	V_{IH}		2.2	—	V_{CC}	V
	V_{IL}		-0.3	—	0.8	V
Output Voltage	V_{OH}	$I_{OH}=-205\mu A$	2.4	—	—	V
	V_{OL}	$I_{OL}=3.2mA$	—	—	0.4	V
Input Leakage Current	I_{LI}	$V_{IN}=0\sim 5.5V$	—	—	2.5	μA
Output Leakage Current	I_{LOH}	$CS=0.8V, \overline{CS}=2.2V$	$V_{out}=2.4V$	—	10	μA
	I_{LOL}		$V_{out}=0.4V$	—	10	μA
Active Supply Current	I_{CC}^*	$V_{CC}=5.5V, I_{DOUT}=0mA$	—	10	25	mA
Stand by Supply Current	I_{SB}	$\overline{CS} \geq V_{CC}-0.2V, CS \leq 0.2V, V_{CC}=5.5V$	—	1	30	μA
Input Capacitance	C_{in}	$V_{in}=0V, f=1MHz, T_a=25^\circ C$	—	—	10	pF
Output Capacitance	C_{out}		—	—	15	pF

* Steady state current

RECOMMENDED AC OPERATING CHARACTERISTICS

READ SEQUENCE ($V_{CC}=5V \pm 10\%$, $V_{SS}=0V$, $T_a=-20$ to $+75^\circ C$, $t_r=t_f=20ns$)

Item	Symbol	min	max	Unit
Read Cycle Time	t_{RC}	250	—	ns
Address Access Time	t_{AA}	—	250	ns
Chip Select Access Time	t_{ACS}	—	250	ns
Chip Selection to Output in Low Z	t_{CLZ}	10	—	ns
Chip deselection to Output in High Z	t_{CHZ}	0	100	ns
Output Hold from Address Change	t_{OH}	10	—	ns

READ CYCLE (1)

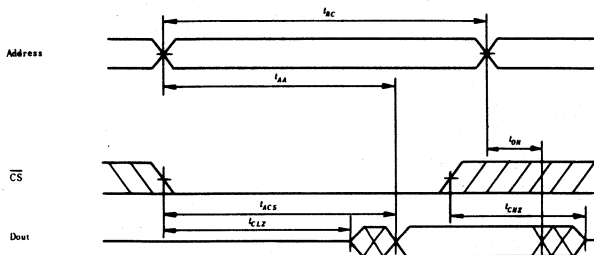

READ CYCLE (2) (Notes 1)

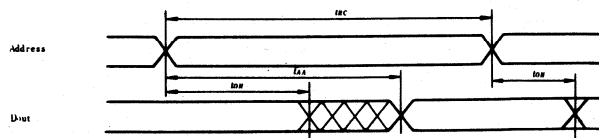

READ CYCLE (3) (Notes 2)

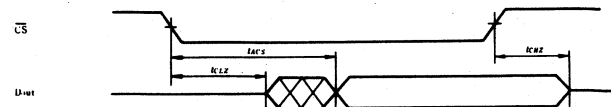

AC TEST LOAD

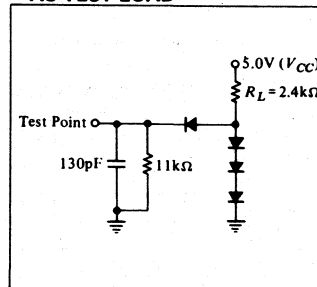

- Notes) 1. $t_r=t_f=20ns$.
- 2. C_L includes jig capacitance.
- 3. All diodes are 1S2074Ⓢ.

- Notes)
- 1. Device is continuously selected
- 2. Address Valid prior to or coincident with \overline{CS} transition low.

HN61366P

8192-word × 8-bit Mask Programmable Read Only Memory

The HN61366P is a mask-programmable, byte-organized memory designed for use in bus-organized systems.

To facilitate use, the device operates from a single power supply, has compatibility with TTL, and requires no clocks or refreshing because of static operation.

The active level of the OE input and the memory content are defined by the user.

■ FEATURES

- Fully Static Operation
- Single +5V power supply
- Three-State Data Output for OR-Ties
- Mask Programmable Output Enable
- TTL Compatible
- Maximum Access Time; 250ns
- Low Power Operation; 50mW (typ.)
- Pin Compatible with EPROM

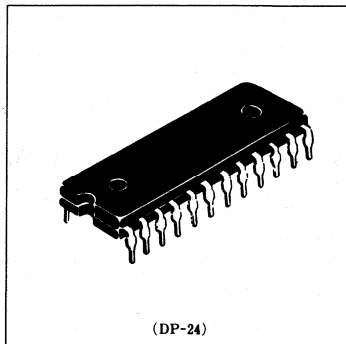

(DP-24)

■ PIN ARRANGEMENT

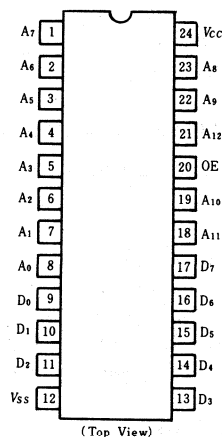

■ BLOCK DIAGRAM

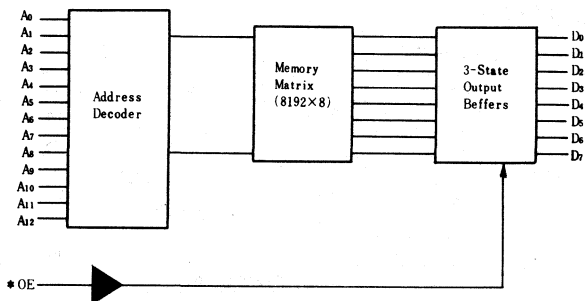

* Active level defined by the user.

■ ABSOLUTE MAXIMUM RATINGS

Item	Symbol	Value	Unit
Supply Voltage*	V_{CC}	-0.3 to +7.0	V
Input Voltage*	V_{in}	-0.3 to +7.0	V
Operating Temperature	T_{opr}	-20 to +75	°C
Storage Temperature	T_{stg}	-55 to +125	°C
Storage Temperature (under bias)	T_{bias}	-20 to +85	°C

* With respect to V_{SS}

■ RECOMMENDED DC OPERATING CONDITIONS

Item	Symbol	min	typ	max	Unit
Supply Voltage*	V_{CC}	4.5	5.0	5.5	V
Input Voltage*	V_{IL}	-0.3	—	0.8	V
	V_{IH}	2.2	—	V_{CC}	V
Operating Temperature	T_{opr}	-20	—	75	°C

* With respect to V_{SS}

■ ELECTRICAL CHARACTERISTICS ($V_{CC}=5V \pm 10\%$, $V_{SS}=0V$, $T_a=-20$ to $+75^\circ C$)

Item	Symbol	Test Conditions	min	typ	max	Unit
Input Voltage	V_{IH}		2.2	—	V_{CC}	V
	V_{IL}		-0.3	—	0.8	V
Output Voltage	V_{OH}	$I_{OH}=-205\mu A$	2.4	—	—	V
	V_{OL}	$I_{OL}=3.2mA$	—	—	0.4	V
Input Leakage Current	I_{LI}	$V_{IN}=0-5.5V$	—	—	2.5	μA
Output Leakage Current	I_{LOH}	OE=0.8V, $\overline{OE}=2.2V$	$V_{OUT}=2.4V$	—	10	μA
	I_{LOL}		$V_{OUT}=0.4V$	—	10	μA
Operating Supply Current	I_{CC}^*	$V_{CC}=5.5V$, $I_{OUT}=0mA$	—	10	25	mA
Input Capacitance	C_{in}	$V_{in}=0V$, $f=1MHz$, $T_a=25^\circ C$	—	—	10	pF
Output Capacitance	C_{out}		—	—	15	pF

* Steady state current

■ RECOMMENDED AC OPERATING CONDITIONS

● READ CYCLE ($V_{CC}=5V \pm 10\%$, $V_{SS}=0V$, $T_a=-20 \sim +75^\circ C$, $t_r=t_f=20ns$)

Item	Symbol	min	max	Unit
Read Cycle Time	t_{RC}	250	—	ns
Address Access Time	t_{AA}	—	250	ns
Output Enable to Output Valid	t_{OE}	—	100	ns
Output Enable to Output in Low Z	t_{OLZ}	10	—	ns
Output Disable to Output in High Z	t_{OHZ}	0	100	ns
Output Hold from Address Change	t_{OH}	10	—	ns

● LOAD CIRCUIT

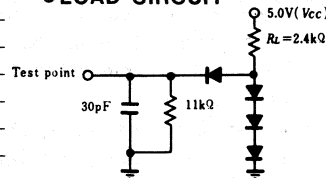

- Notes 1. $t_r=t_f=20ns$
- 2. C_i includes jig capacitance.
- 3. All diodes are 1S2074Ⓢ.

■ TIMING WAVEFORM

● READ CYCLE (1)

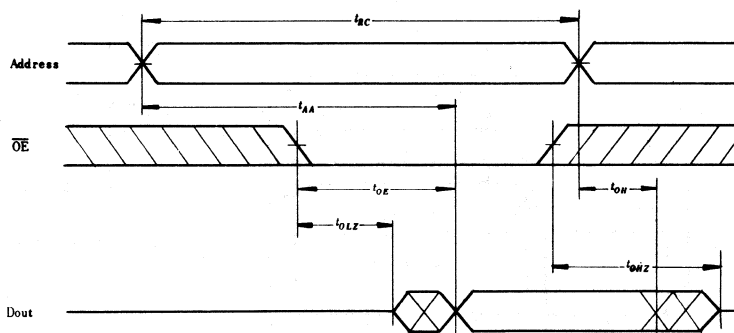

● READ CYCLE (2) ^{Note 1)}

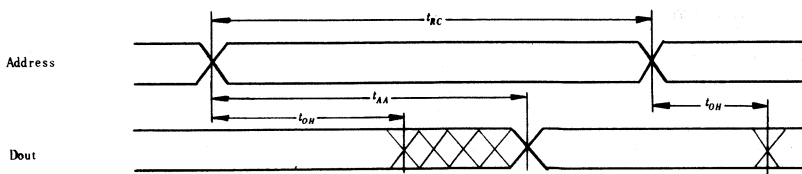

Note) 1. $\overline{OE}=V_{IL}$

HN43128P

16384 × 8-bit or 32768 × 4-bit CMOS Mask Programmable Read Only Memory

The Hitachi HN43128P is a mask programmable, 16384x8-bit or 32768x4-bit CMOS read only memory. It operates from a single power supply and is compatible with TTL and DTL. Low power consumption makes this memory well-suited for battery-operation or hand-held personal computers. Memory expansion can be implemented through two chip select inputs. Either active "High" or active "Low" of chip select inputs and a chip enable input is defined at mask level. The organization of 8 bit or 4 bit is designed by the user.

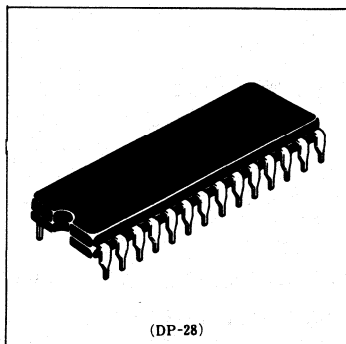

■ FEATURES

- Mask-programmable for either 4-bit or 8-bit organization.
- Three-state outputs, can be wired-OR.
- Two mask programmable chip select terminals facilitate memory expansion.
- A single 5V power supply ($\pm 10\%$).
- Low power consumption: Operation 3mW (typ.), Standby 3 μ W (typ.)
- TTL compatible
- Access time: 6.5 μ s (max)

■ BLOCK DIAGRAM

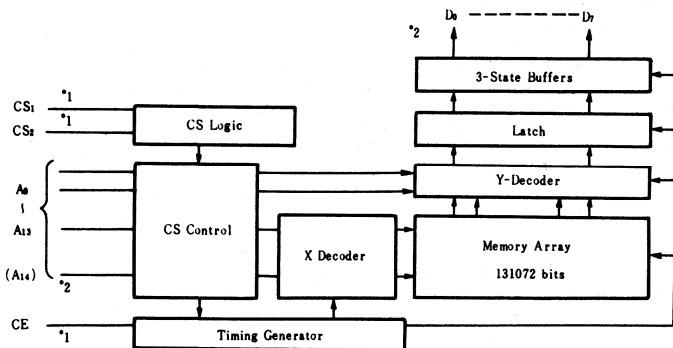

*1 Active level defined at mask level.

*2 Mask programmable selection of either 4-bit or 8-bit organization.

In 4-bit organization, data outputs are D₀ to D₃.

■ PIN ARRANGEMENT

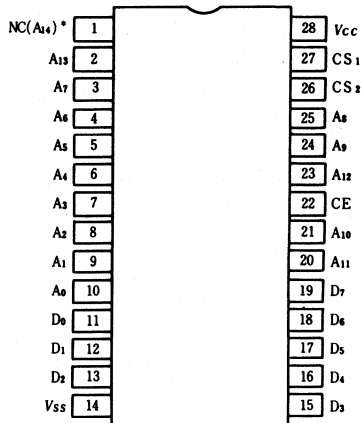

(Top View)

* The most significant address in 4-bit organization.

■ ABSOLUTE MAXIMUM RATINGS

Item	Symbol	Rating	Unit
Supply Voltage*	V_{CC}	-0.3~+7.0	V
Input Voltage*	V_{in}	-0.3~+7.0	V
Operating Temperature Range	T_{opr}	-20~+75	°C
Storage Temperature	T_{stg}	-55~+125	°C
Bias Storage Temperature	T_{bias}	-20~+85	°C

Note : * Referenced to V_{SS} .

■ ELECTRICAL CHARACTERISTICS ($V_{CC}=5V \pm 10\%$, $V_{SS}=0V$, $T_a=-20 \sim +75^\circ C$)

Item	Symbol	Test Condition	min	typ	max	Unit
Input "High" Level Voltage	V_{IH}		2.4	—	V_{CC}	V
Input "Low" Level Voltage	V_{IL}		0	—	0.8	V
Output "High" Level Voltage	V_{OH}	$I_{OH} = -100 \mu A$	2.4	—	—	V
Output "Low" Level Voltage	V_{OL}	$I_{OL} = 1.6 mA$	—	—	0.4	V
Input Leakage Current	I_{in}	$V_{in} = 0 \sim 5.5 V$	—	—	2.5	μA
Output "High" Level Leakage Current	I_{LOH}	$CE = 0.8 V$	—	—	5	μA
		$CE = 2.4 V$	—	—	5	μA
Output "Low" Level Leakage Current	I_{LOL}	$V_{out} = 2.4 V$	—	—	5	μA
		$V_{out} = 0.4 V$	—	—	5	μA
Supply Current	In stand-by	I_{SB}	—	1	30	μA
	In operation	I_{CC}^*	—	0.6	1.5	mA
Input Capacitance	C_{in}	$V_{in} = 0V, f = 1MHz, T_a = 25^\circ C$	—	—	10	pF
Output Capacitance	C_{out}		—	—	12.5	pF

* Steady state current

■ AC OPERATING CHARACTERISTICS

● READ SEQUENCE ($V_{CC}=5V \pm 10\%$, $V_{SS}=0V$, $T_a=-20$ to $+75^\circ C$, $t_r=t_f=20ns$)

Item	Symbol	min	max	Unit
Read Cycle Time	t_{RC}	7.5	—	μs
Address Access Time	t_{AAC}	—	6.5	μs
Chip Enable Access Time	t_{EACC}	—	6.0	μs
Data Hold Time from Address	t_{DF}	0.05	0.5	μs
Address Set-up Time	t_{AS}	0.5	—	μs
Address Hold Time	t_{AH}	0	—	μs
Chip Enable ON Time	t_{CE}	6.0	—	μs
Chip Enable OFF Time	t_{CE}	1.0	—	μs

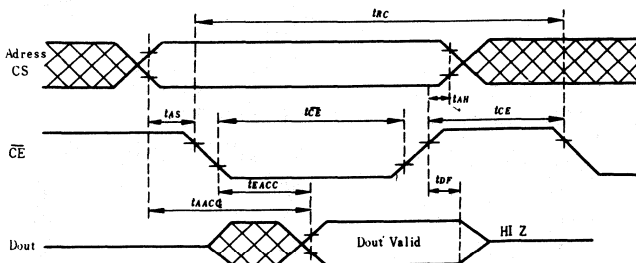

● LOAD CIRCUIT

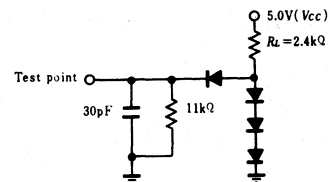

- Notes : 1. $t_r = t_f = 20ns$.
- 2. C_L includes jig capacitance.
- 3. All diodes are 1S2074 (D).

HN613128P, HN613128FP

16384-word × 8-bit Mask Programmable Read Only Memory

The HN613128P/FP is a mask-programmable, byte-organized memory designed for use in bus-organized systems. To facilitate use, the device operates from a single power supply, has compatibility with TTL, and requires no clocks or refreshing because of static operation. The active level of the CS, OE₀, OE₁ input and the memory content are defined by the user. The Chip Select input deselected the output and puts the chip in a power-down mode.

FEATURES

- Fully Static Operation
- Automatic Power Down
- Single +5-Volt Power Supply
- Three-State Data Output for OR-Ties
- Mask Programmable Chip Select, Output Enable
- TTL Compatible
- Maximum Access Time; 250ns
- Low Power Standby and Low Power Operation;
 - Standby: 5μW (typ.)
 - Operation: 50mW (typ.)
- Pin Compatible with EPROM

BLOCK DIAGRAM

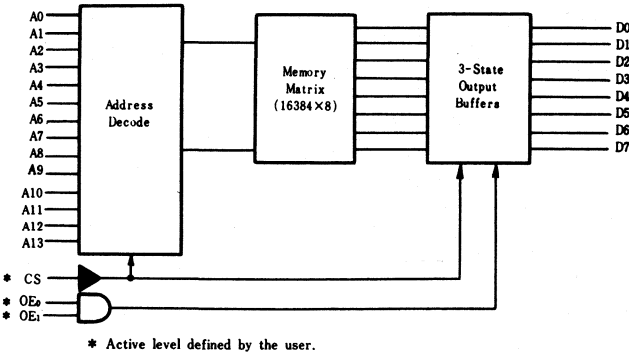

ABSOLUTE MAXIMUM RATINGS

Item	Symbol	Value	Unit
Supply Voltage*	V _{CC}	-0.3 to +7.0	V
Input Voltage*	V _{in}	-0.3 to +7.0	V
Operating Temperature Range	T _{opr}	-20 to +75	°C
Storage Temperature Range	T _{stg}	-55 to +125	°C
Storage Temperature Range (under bias)	T _{bia}	-20 to +85	°C

* With respect to V_{SS}.

RECOMMENDED DC OPERATING CONDITIONS

Item	Symbol	min.	typ.	max.	Unit
Supply Voltage*	V _{CC}	4.5	5.0	5.5	V
Input Voltage*	V _{IL}	-0.3	—	0.8	V
	V _{IH}	2.2	—	V _{CC}	V
Operating Temperature	T _{opr}	-20	—	75	°C

* With respect to V_{SS}.

HN613128P

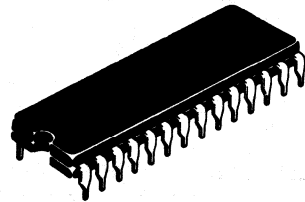

(DP-28)

HN613128FP

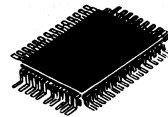

(FP-54)

PIN ARRANGEMENT

● HN613128P

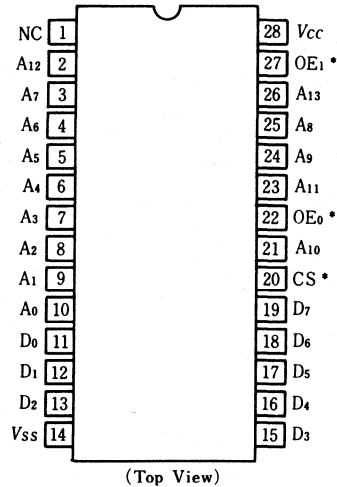

● HN613128FP

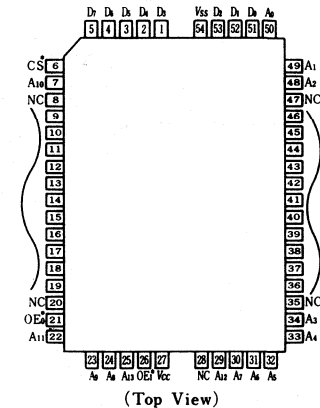

■ ELECTRICAL CHARACTERISTICS ($V_{CC}=5.0V \pm 10\%$, $V_{SS}=0V$, $T_a=-20$ to $+75^\circ C$)

Item	Symbol	Test Condition	min	typ	max	Unit
Input High-level Voltage	V_{IH}		2.2	—	V_{CC}	V
Input Low-level Voltage	V_{IL}		-0.3	—	0.8	V
Output High-level Voltage	V_{OH}	$I_{OH} = -205 \mu A$	2.4	—	—	V
Output Low-level Voltage	V_{OL}	$I_{OL} = 3.2 mA$	—	—	0.4	V
Input Leakage Current	I_{in}	$V_{in} = 0$ to $5.5V$	—	—	2.5	μA
Output High-level Leakage Current	I_{LOH}	$V_{out} = 2.4V$, $CS = 0.8V$, $\overline{CS} = 2.2V$	—	—	10	μA
Output Low-level Leakage Current	I_{LOL}	$V_{out} = 0.4V$, $CS = 0.8V$, $\overline{CS} = 2.2V$	—	—	10	μA
Supply Current (Active/Standby)	I_{CC}^*/I_{st}	$V_{CC} = 5.5V$, $I_{DOUT} = 0mA / \overline{CS} \geq V_{CC} - 0.2V, CS \leq 0.2V$	—	10/1	25/30	mA / μA
Input Capacitance	C_{in}	$V_{in} = 0V$, $f = 1.0MHz$, $T_a = 25^\circ C$	—	—	10	pF
Output Capacitance	C_{out}	$V_{in} = 0V$, $f = 1.0MHz$, $T_a = 25^\circ C$	—	—	15	pF

* Steady state current

■ RECOMMENDED AC OPERATING CONDITIONS (READ SEQUENCE)

($V_{CC}=5.0V \pm 10\%$, $V_{SS}=0V$, $T_a=-20$ to $+75^\circ C$, All timing with $t_r = t_f = 20ns$)

Item	Symbol	HN613128P		Unit
		min	max	
Read Cycle Time	t_{RC}	250	—	ns
Address Access Time	t_{AA}	—	250	ns
Chip Select Access Time	t_{ACS}	—	250	ns
Chip Selection to Output in Low Z	t_{CLZ}	10	—	ns
Output Enable to Output Valid	t_{OE}	—	100	ns
Output Enable to Output in Low Z	t_{OLZ}	10	—	ns
Chip deselection to Output in High Z	t_{CHZ}	0	100	ns
Chip Disable to Output in High Z	t_{OHZ}	0	100	ns
Output Hold from Address Change	t_{OH}	10	—	ns

■ TIMING WAVEFORM

● READ CYCLE (1)

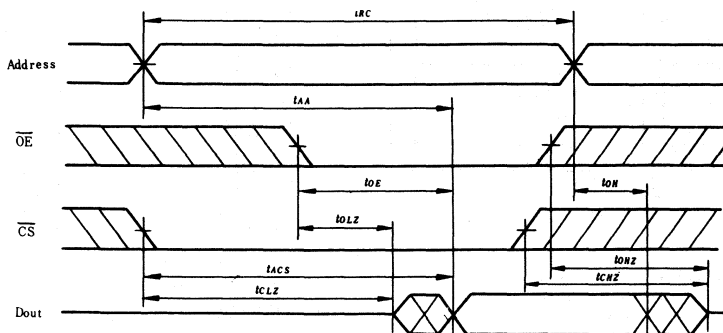

● READ CYCLE (2) (Notes 1, 3)

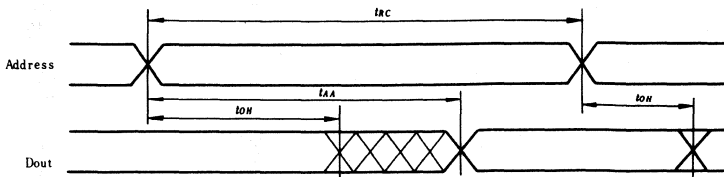

● READ CYCLE (3) (Notes 2, 3)

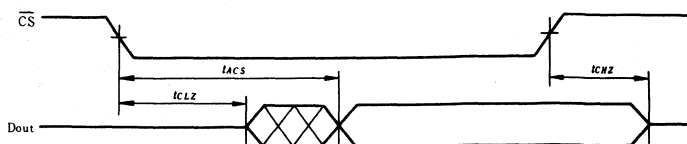

● AC TEST LOAD

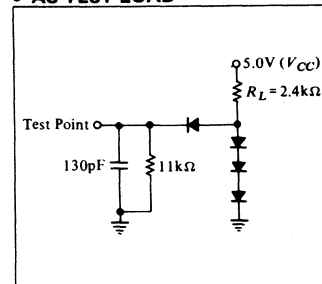

- Notes) 1. $t_r = t_f = 20ns$.
- 2. C_L includes jig capacitance.
- 3. All diodes are 1S2074®.

NOTES:

- 1. Device is continuously selected.
- 2. Address Valid prior to or coincident with CS transition low.
- 3. $OE = V_{IL}$.

HN61256P, HN61256FP

32768×8-bit or 65536×4-bit CMOS Mask Programmable Read Only Memory

The Hitachi HN61256P/FP is a mask programmable 32768 x 8-bit or 65536x4-bit CMOS read only memory. It operates from a single power supply and is compatible with TTL. Low power consumption makes this memory well-suited for battery-operation or hand-held personal computers. Memory expansion can be implemented through one chip select input. Either active "High" or active "Low" or chip select input and a chip enable input are defined at mask level. The organization of 8 bit or 4 bit is defined by the user.

FEATURES

- Mask-programmable selection of either 4-bit or 8-bit organization
- Three-state outputs, can be wire-ORed.
- One mask programmable chip select terminal facilitates memory expansion.
- A single 5V power supply ($\pm 10\%$)
- Low power consumption: Operation 7.5mW (typ.), Standby 5 μ W (typ.)
- TTL compatible
- Access time: 3.5 μ s (max)

BLOCK DIAGRAM

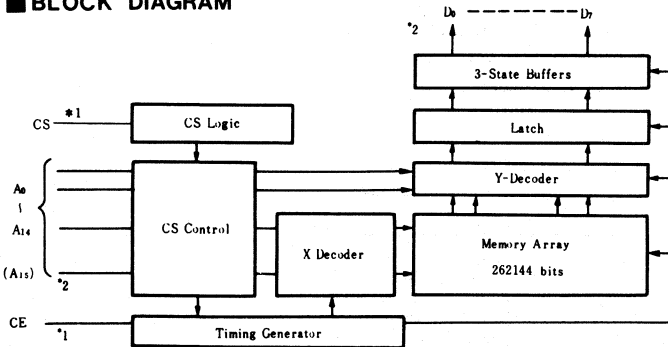

- *1 Active level defined at mask level.
 *2 Mask programmable selection of either 4-bit or 8-bit organization.
 In 4-bit organization, data outputs are D₀ to D₃.

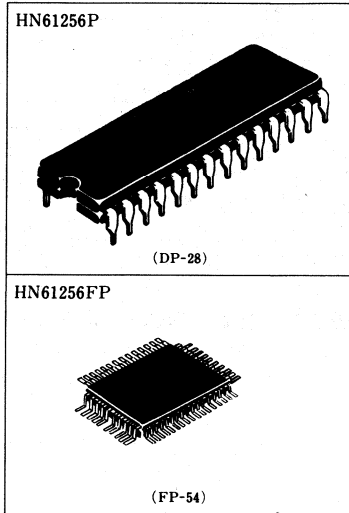

PIN ARRANGEMENT

HN61256P

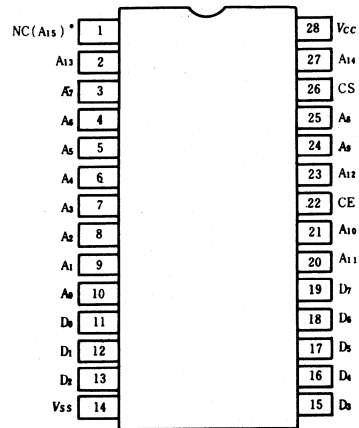

(Top View)

HN61256FP

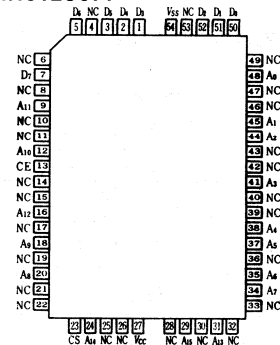

(Top View)

■ ABSOLUTE MAXIMUM RATINGS

Item	Symbol	Rating	Unit
Supply Voltage*	V_{CC}	-0.3~+7.0	V
Input Voltage*	V_{in}	-0.3~+7.0	V
Operating Temperature Range	T_{opr}	0~+75	°C
Storage Temperature Range	T_{stg}	-55~+125	°C
Bias Storage Temperature Range	T_{bia}	-20~+85	°C

Note: * Referenced to V_{SS} .

■ ELECTRICAL CHARACTERISTICS

($V_{CC}=5V \pm 10\%$, $V_{SS}=0V$, $T_a=0 \sim +75^\circ C$)

Item	Symbol	Test Condition	min	typ	max	Unit	
Input "High" Level Voltage	V_{IH}		2.4	—	V_{CC}	V	
Input "Low" Level Voltage	V_{IL}		0	—	0.8	V	
Output "High" Level Voltage	V_{OH}	$I_{OH} = -100 \mu A$	2.4	—	—	V	
Output "Low" Level Voltage	V_{OL}	$I_{OL} = 1.6 mA$	—	—	0.4	V	
Input Leakage Current	I_{in}	$V_{in} = 0 \sim 5.5 V$	—	—	2.5	μA	
Output "High" Level Leakage Current	I_{LOH}	CE = 0.8 V	—	—	5	μA	
Output "Low" Level Leakage Current	I_{LOL}	CE = 2.4 V	—	—	5	μA	
Supply Current	In stand-by	I_{SB}	$CS \geq V_{CC} - 0.2 V$ $CS \leq V_{SS} + 0.2 V$ $V_{CC} = 5.5 V$		—	1	μA
	In operation	I_{CC}^*	$t_{RC} = 4.0 \mu s$		—	1.5	3.0
Input Capacitance	C_{in}	$V_{in} = 0 V, f = 1 MHz, T_a = 25^\circ C$	—	—	10	pF	
Output Capacitance	C_{out}		—	—	12.5	pF	

* Steady state current

■ AC OPERATING CONDITION AND CHARACTERISTICS

● READ SEQUENCE ($V_{CC}=5V \pm 10\%$, $V_{SS}=0V$, $T_a=0 \sim +75^\circ C$, $t_r = t_f = 20 ns$)

Item	Symbol	min	max	Unit
Read Cycle Time	t_{RC}	4.0	—	μs
Address Access Time	t_{AACC}	—	3.5	μs
Chip Enable Access Time	t_{EACC}	—	3.0	μs
Data Hold Time from Address	t_{DF}	0.05	0.5	μs
Address Set-up Time	t_{AS}	0.5	—	μs
Address Hold Time	t_{AH}	0	—	μs
Chip Enable ON Time	t_{CE}	3.0	—	μs
Chip Enable OFF Time	$t_{\overline{CE}}$	0.5	—	μs

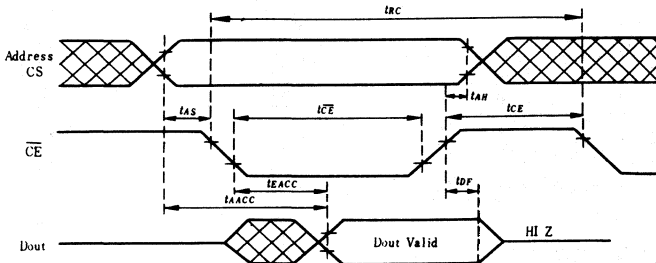

● LOAD CIRCUIT

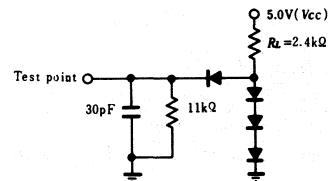

- Notes: 1. $t_r = t_f = 20 ns$.
- 2. C_L includes jig capacitance.
- 3. All diodes are 1S2074 Ⓢ.

HN613256P, HN613256FP

32768-word x 8-bit Mask Programmable Read Only Memory

The HN613256P/FP is a mask-programmable, byte-organized memory designed for use in bus-organized system.

To facilitate use, the device operates from a single power supply, has compatibility with TTL, and requires no clocks nor refreshing because of static operation.

The active level of the CS and OE input, and the memory content are defined by the user. The Chip Select input deselected the output and puts the chip in a power-down mode.

■ FEATURES

- Fully Static Operation
- Automatic Power Down
- Single +5V Power Supply
- Three-state Data Output for OR-ties
- Mask Programmable Chip Select and Output Enable
- TTL Compatible
- Maximum Access Time: 250ns
- Low Power Standby and Low Power Operation; Standby 5μW (typ.), Operation 50mW (typ.)
- Pin Compatible with EPROM

■ BLOCK DIAGRAM

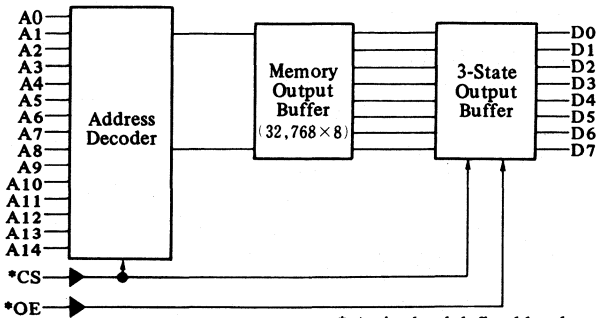

* Active level defined by the user.

■ ABSOLUTE MAXIMUM RATINGS

Item	Symbol	Value	Unit
Supply Voltage*	V_{CC}	-0.3 to +7.0	V
Input Voltage*	V_{in}	-0.3 to +7.0	V
Operating Temperature Range	T_{opr}	-20 to +75	°C
Storage Temperature Range	T_{stg}	-55 to +125	°C
Storage Temperature Range (Under Bias)	T_{bias}	-20 to +85	°C

*With respect to V_{SS}

■ RECOMMENDED DC OPERATING CONDITIONS

Item	Symbol	min.	typ.	max.	Unit
Supply Voltage *	V_{CC}	4.5	5.0	5.5	V
Input Voltage*	V_{IL}	-0.3	—	0.8	V
	V_{IH}	2.2	—	V_{CC}	V
Operating Temperature	T_{opr}	-20	—	75	°C

* With respect to V_{SS} .

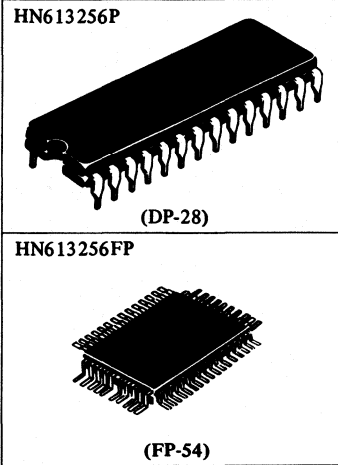

■ PIN ARRANGEMENT

● HN613256P

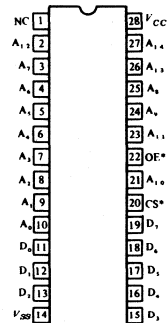

(Top View)

* Active level can be defined by the customer.

● HN613256FP

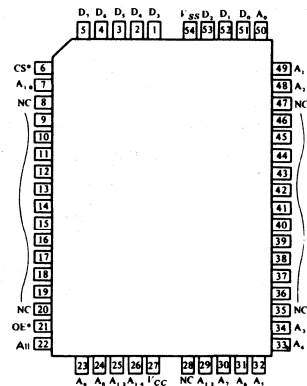

(Top View)

* Active level can be defined by the customer.

■ ELECTRICAL CHARACTERISTICS ($V_{CC} = 5.0V \pm 10\%$, $V_{SS} = 0V$, $T_a = -20 \sim +75^\circ C$)

Item	Symbol	Test Condition	min	typ	max	Unit		
Input Voltage	V_{IH}		2.2	—	V_{CC}	V		
	V_{IL}		-0.3	—	0.8	V		
Output Voltage	V_{OH}	$I_{OH} = -205 \mu A$	2.4	—	—	V		
	V_{OL}	$I_{OL} = 3.2 \text{ mA}$	—	—	0.4	V		
Input Leakage Current	I_{in}	$V_{in} = 0 \sim 5.5V$	—	—	2.5	μA		
Output Leakage Current	I_{LOH}	CS = 0.8V, $\overline{CS} = 2.2V$	$V_{out} = 2.4V$		—	10	μA	
	I_{LOL}		$V_{out} = 0.4V$		—	10	μA	
Supply Current	Active	I_{CC}^*	$V_{CC} = 5.5V, I_{out} = 0 \text{ mA}$		—	10	30	mA
	Standby	I_{SB}	$V_{CC} = 5.5V, \overline{CS} \geq V_{CC} - 0.2V, CS \leq 0.2V$		—	1	30	μA
Input Capacitance	C_{in}	$V_{in} = 0V, f = 1 \text{ MHz}, T_a = 25^\circ C$	—	—	10	pF		
Output Capacitance	C_{out}		—	—	15	pF		

* Steady state current

■ RECOMMENDED AC OPERATING CONDITIONS (READ SEQUENCE)

($V_{CC} = 5V \pm 10\%$, $V_{SS} = 0V$, $T_a = -20 \sim +75^\circ C$, $t_r = t_f = 20\text{ns}$)

Item	Symbol	min	max	Unit
Read Cycle Time	t_{RC}	250	—	ns
Address Access Time	t_{AA}	—	250	ns
Chip Select Access Time	t_{ACS}	—	250	ns
Chip Selection to Output in Low Z	t_{CLZ}	10	—	ns
Output Enable to Output Valid	t_{OE}	—	100	ns
Output Enable to Output in Low Z	t_{OLZ}	10	—	ns
Chip Deselection to Output in High Z	t_{CHZ}	0	100	ns
Chip Disable to Output in High Z	t_{OHZ}	0	100	ns
Output Hold from Address Change	t_{OH}	10	—	ns

■ TIMING WAVEFORM

● READ CYCLE (1)

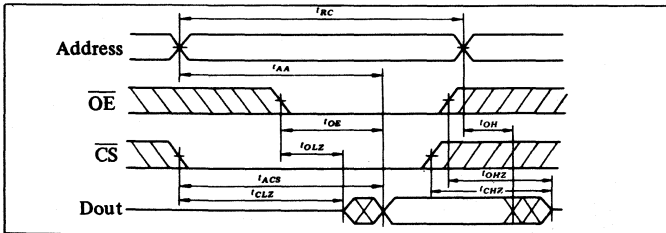

● READ CYCLE (2) (Notes 1, 3)

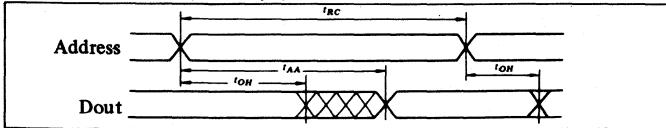

● READ CYCLE (3) (Notes 2, 3)

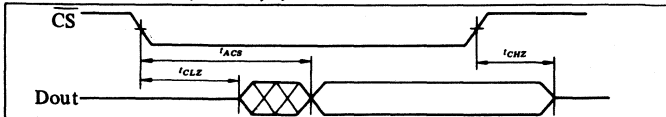

● LOAD CIRCUIT

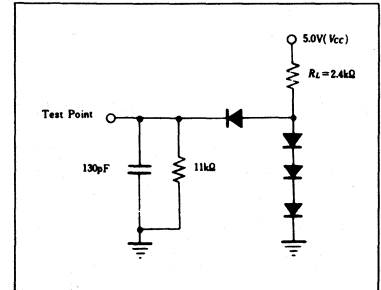

- Notes : 1. $t_r = t_f = 20\text{ns}$
- 2. C_L includes jig capacitance
- 3. All diodes are 1S2074®

NOTES:

1. Device is continuously selected.
2. Address Valid prior to or coincident with \overline{CS} transition low.
3. $OE = V_{IL}$.

131,072-word × 8-bit Mask Programmable Read Only Memory

The HN62301P is a mask-programmable, byte-organized memory designed for use in bus-organized systems. To facilitate use, the device operates from a single power supply, has compatibility with TTL, and requires no clocks or refreshing because of static operation. The Chip Enable and the memory content are defined by the user. The Chip Enable input deselected the output and puts the chip in a power-down mode.

FEATURES

- Static Operation
- Automatic Power Down
- Single +5-Volt Power Supply
- Three-State Data Output for OR-Ties
- TTL Compatible
- Maximum Access Time-350ns
- Lower Power Standby and Low Power Operation; Standby: 2mW (typ.), Operation: 75mW (typ.)

BLOCK DIAGRAM

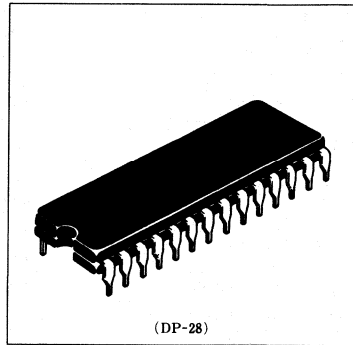
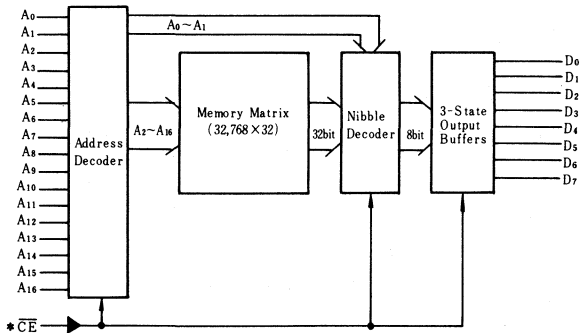

(DP-28)

PIN ARRANGEMENT

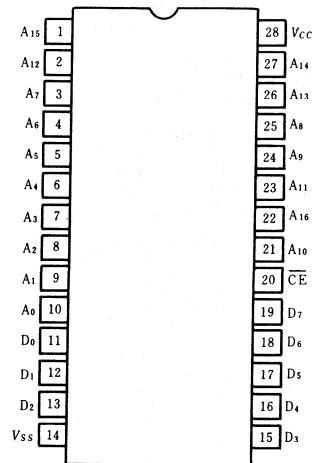

(Top View)

ABSOLUTE MAXIMUM RATINGS

Item	Symbol	Value	Unit
Supply Voltage*	V_{CC}	-0.3 to +7.0	V
Input Voltage*	V_{in}	-0.3 to +7.0	V
Operating Temperature Range	T_{opr}	0 to +70	°C
Storage Temperature Range	T_{stg}	-55 to +125	°C
Bias Storage Temperature Range	T_{bias}	-20 to +85	°C

* With respect to V_{SS}

Note) The specifications of this device are subject to change without notice.
Please contact your nearest Hitachi Sales Dept, regarding specifications.

RECOMMENDED DC OPERATING CONDITIONS ($T_a=0$ to 70°C)

Item	Symbol	min	typ	max	Unit
Supply Voltage*	V_{CC}	4.5	5.0	5.5	V
Input Voltage*	V_{IL}	-0.3	—	0.8	V
	V_{IH}	2.2	—	V_{CC}	V

* with respect V_{SS}

ELECTRICAL CHARACTERISTICS ($V_{CC}=5V\pm 10\%$, $V_{SS}=0V$, $T_a=0$ to $+70^\circ\text{C}$)

Item	Symbol	Test Conditions	min	typ	max	Unit	
Normal Operating Current	I_{CC1} *	$t_{RC1}=\text{min}$, $V_{CC}=5.5V$, $I_{out}=0\text{mA}$	—	15	50**	mA	
Nibble Operating Current	I_{CC2} *	$t_{RC2}=\text{min}$, $V_{CC}=5.5V$, $I_{out}=0\text{mA}$	—	15	50**	mA	
Stand by Current	I_{SB}	$\overline{CE}\geq V_{CC}-0.2V$, $V_{CC}=5.5V$	—	0.4	10	mA	
Input Leakage Current	I_{LI}	$V_{IN}=0$ to $5.5V$, other $0V$	-10	—	10	μA	
Output Leakage Current	I_{LOH}	$\overline{CE}=2.2V$	$V_{out}=2.4V$	—	—	10	μA
	I_{LOL}			$V_{out}=0.4V$	—	—	10
Output Voltage	V_{OH}	$I_{out}=-205\mu\text{A}$	2.4	—	—	V	
	V_{OL}	$I_{out}=3.2\text{mA}$	—	—	0.4	V	

* Steady state current

** TBD

CAPACITANCE ($V_{CC}=5V\pm 10\%$, $T_a=25^\circ\text{C}$, 1MHz $V_{in}=0V$)

Item	Symbol	typ	max	Unit
Input Capacitance ($A_0\sim A_{16}$, \overline{CE})	C_{in}	TBD	10	pF
Output Capacitance ($D_0\sim D_7$)	C_{out}	TBD	15	pF

AC CHARACTERISTICS ($V_{CC}=5V\pm 10\%$, $V_{SS}=0V$, $T_a=0$ to $+70^\circ\text{C}$, $t_r=t_f=20\text{ns}$)

Mode	Item	Symbol	min	max	Unit
Normal	Cycle Time	t_{RC1}	350	—	ns
	Address Access Time	t_{AA1}	—	350	ns
	Data Hold Time	t_{OH}	10	—	ns
\overline{CE} operation	\overline{CE} Access Time	t_{ACE}	—	350	ns
	\overline{CE} Enable Pulse Width	t_{CE}	350	—	ns
	\overline{CE} Disable Pulse Width	$t_{\overline{CE}}$	15**	—	ns
	Address Set up Time	t_{AS}	0	—	ns
	Data Hold Time from \overline{CE}	t_{CHZ}	10**	—	ns
	Data Set Time from \overline{CE}	t_{CLZ}	10	—	ns
Nibble operation	Nibble Address Access Time*	t_{AA2}	—	50	ns
	Nibble Cycle Time	t_{RC2}	50	—	ns
Turn-on & Turn-off Time		t_T	—	40	ns

* Nibble Address A_0, A_1

** TBD

■ TIMMING CHART

● NORMAL CYCLE (\overline{CE} = Low)

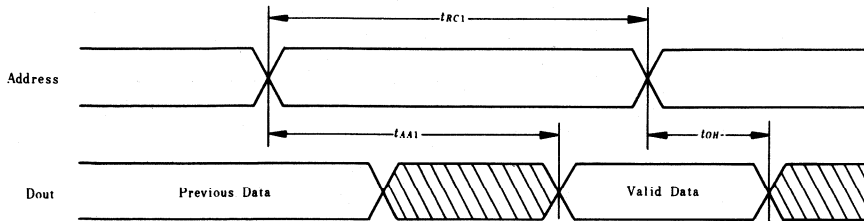

● \overline{CE} CYCLE

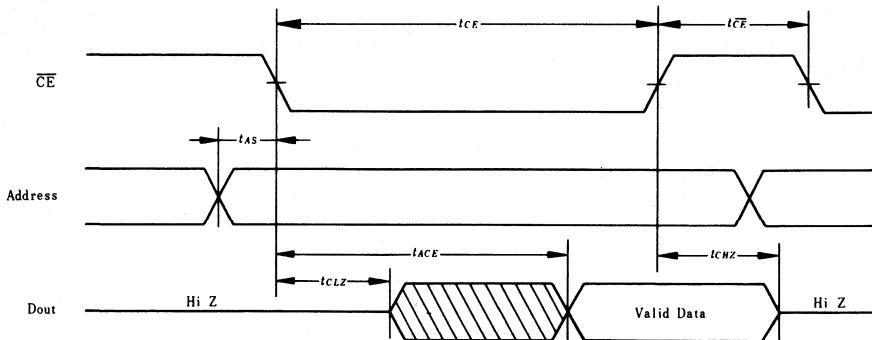

● NIBBLE CYCLE

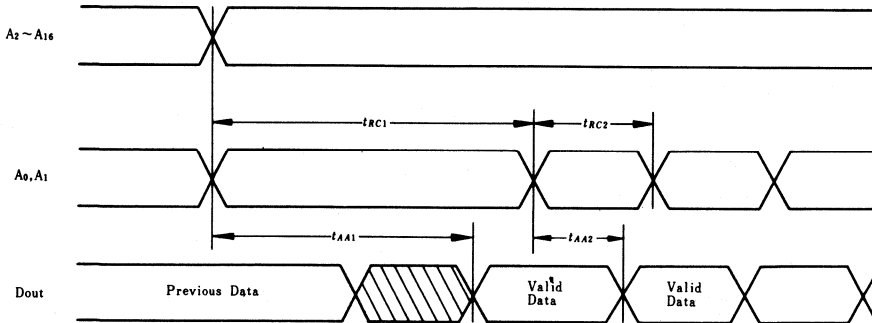

● AC TEST LOAD

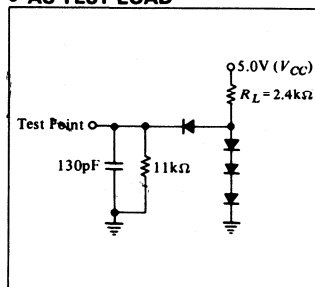

- Notes) 1. $t_r = t_f = 20\text{ns}$
 2. C_L includes jig capacitance.
 3. All diodes are 1S2074 Φ .

MOS PROM

HN462716, HN462716G

2048-word × 8-bit U.V. Erasable and Electrically Programmable Read Only Memory

The HN462716 is a 2048 word by 8 bit erasable and electrically programmable ROMs. This device is packaged in a 24-pin, dual-in-line package with transparent lid. The transparent lid allows the user to expose the chip to ultraviolet light to erase the bit pattern, whereby a new pattern can then be written into the device.

- Single Power Supply +5V ±5%
- Simple Programming Program Voltage: +25V DC
Programs with One 50ms Pulse
- Static No Clocks Required
- Inputs and Outputs TTL Compatible During Both Read and Program Modes
- Fully Decoded-on Chip Address Decode
- Access Time 450ns Max.
- Low Power Dissipation . . 555mW Max. Active Power
161mW Max. Standby Power
- Three State Output OR- Tie Capability
- Interchangeable with Intel 2716

■ BLOCK DIAGRAM

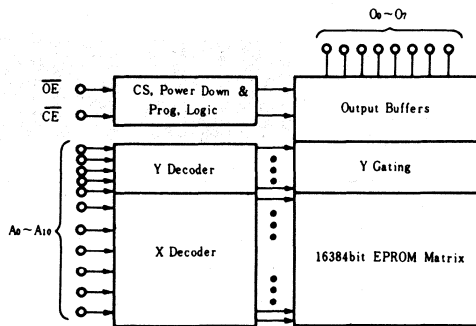

■ PROGRAMMING OPERATION

Mode	Pins	\overline{CE} (18)	\overline{OE} (20)	V_{PP} (21)	V_{CC} (24)	Outputs (9~11, 13~17)
Read		V_{IL}	V_{IL}	+5	+5	Dout
Deselect		Don't Care	V_{IH}	+5	+5	High Z
Power Down		V_{IH}	Don't Care	+5	+5	High Z
Program		Pulsed V_{IL} to V_{IH}	V_{IH}	+25	+5	Din
Program Verify		V_{IL}	V_{IL}	+25	+5	Dout
Program Inhibit		V_{IL}	V_{IH}	+25	+5	High Z

■ ABSOLUTE MAXIMUM RATINGS

Item	Symbol	Value	Unit
Operating Temperature Range	T_{op}	0 to +70	°C
Storage Temperature Range	T_{stg}	-65 to +125	°C
All Input and Output Voltages*	V_T	-0.3 to +7	V
V_{PP} Supply Voltage*	V_{PP}	-0.3 to +28	V

* With respect to Ground

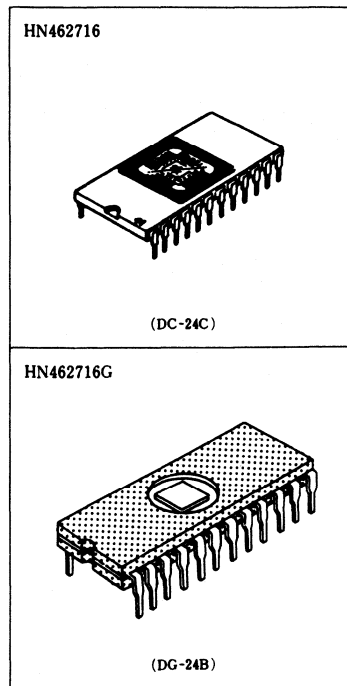

■ PIN ARRANGEMENT

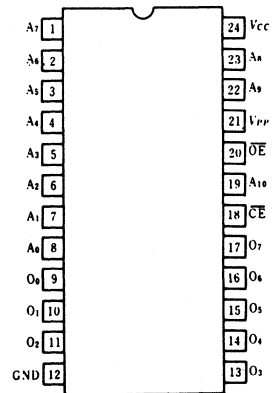

(Top View)

■ READ OPERATION

● DC AND OPERATING CHARACTERISTICS ($T_a = 0$ to $+70^\circ\text{C}$, $V_{CC} = 5\text{V} \pm 5\%$, $V_{PP} = V_{CC} \pm 0.6\text{V}$)

Item	Symbol	Test Condition	min.	typ.	max.	Unit
Input Leakage Current	I_{LI}	$V_{IN} = 5.25\text{V}$	—	—	10	μA
Output Leakage Current	I_{LO}	$V_{OUT} = 5.25\text{V}/0.4\text{V}$	—	—	10	μA
V_{PP} Current	I_{PP1}	$V_{PP} = 5.85\text{V}$	—	—	5	mA
V_{CC} Current (Standby)	I_{CC1}	$\overline{\text{CE}} = V_{IH}, \overline{\text{OE}} = V_{IL}$	—	13	25	mA
V_{CC} Current (Active)	I_{CC2}	$\overline{\text{OE}} = \overline{\text{CE}} = V_{IL}$	—	56	100	mA
Input Low Voltage	V_{IL}		-0.1	—	0.8	V
Input High Voltage	V_{IH}		2.0	—	$V_{CC} + 1$	V
Output Low Voltage	V_{OL}	$I_{OL} = 2.1\text{mA}$	—	—	0.4	V
Output High Voltage	V_{OH}	$I_{OH} = -400\mu\text{A}$	2.4	—	—	V

Note: V_{CC} must be applied simultaneously or before V_{PP} and removed simultaneously or after V_{PP} .

● AC CHARACTERISTICS ($T_a = 0$ to $+70^\circ\text{C}$, $V_{CC} = 5\text{V} \pm 5\%$, $V_{PP} = V_{CC} \pm 0.6\text{V}$)

Parameter	Symbol	Test Condition	min.	typ.	max.	Unit
Address to Output Delay	t_{ACC}	$\overline{\text{OE}} = \overline{\text{CE}} = V_{IL}$	—	—	450	ns
$\overline{\text{CE}}$ to Output Delay	t_{CE}	$\overline{\text{OE}} = V_{IL}$	—	—	450	ns
$\overline{\text{OE}}$ to Output Delay	t_{OE}	$\overline{\text{CE}} = V_{IL}$	—	—	120	ns
$\overline{\text{OE}}$ High to Output Float*	t_{DF}	$\overline{\text{CE}} = V_{IL}$	0	—	100	ns
Address to Output Hold	t_{OH}	$\overline{\text{OE}} = \overline{\text{CE}} = V_{IL}$	0	—	—	ns

* : t_{DF} defines the time at which the output achieves the open circuit condition and is not referenced to output voltage levels.

● CAPACITANCE ($T_a = 25^\circ\text{C}$, $f = 1\text{MHz}$)

Item	Symbol	Test Condition	typ.	max.	Unit
Input Capacitance	C_{in}	$V_{IN} = 0\text{V}$	—	6	pF
Output Capacitance	C_{out}	$V_{OUT} = 0\text{V}$	—	12	pF

● SWITCHING CHARACTERISTICS

Test Conditions

Input Pulse Levels: 0.8V to 2.2V
 Input Rise and Fall Times: $\leq 20\text{ns}$
 Output Load: 1TTL Gate + 100 pF
 Reference Level for Measuring Timing: Inputs 1V and 2V
 Outputs 0.8V and 2V

READ MODE ($\overline{\text{CE}} = V_{IL}$)

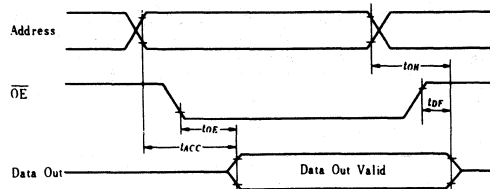

STANDBY MODE ($\overline{\text{OE}} = V_{IL}$)

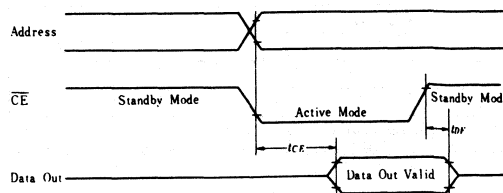

● TYPICAL CHARACTERISTICS

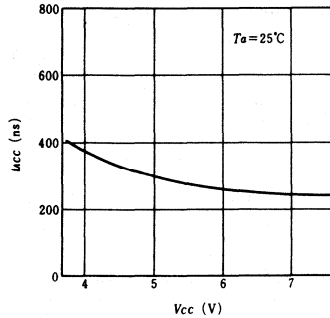
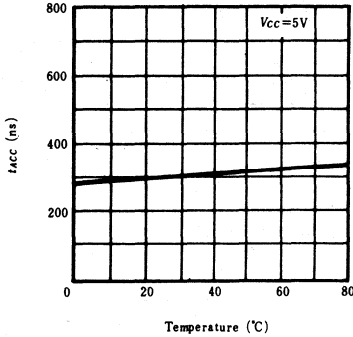
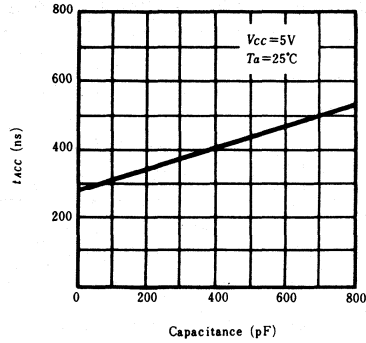
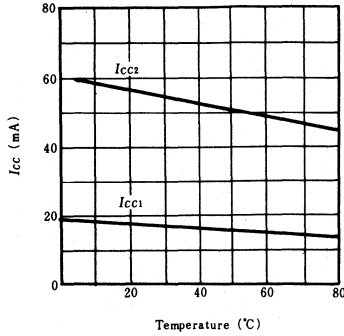

● DC PROGRAMMING CHARACTERISTICS ($T_a=25^{\circ}C \pm 5^{\circ}C$, $V_{CC}=5V \pm 5\%$, $V_{PP}=25V \pm 1V$)

Parameter	Symbol	Test Condition	min.	typ.	max.	Unit
Input Leakage Current	I_{LI}	$V_{IN}=5.25V$	—	—	10	μA
V_{PP} Supply Current	I_{PP1}	$\overline{CE}=V_{IL}$	—	—	5	mA
V_{PP} Supply Current During Programming	I_{PP2}	$\overline{CE}=V_{IH}$	—	—	30	mA
V_{CC} Supply Current	I_{CC}		—	—	100	mA
Input Low Level	V_{IL}		-0.1	—	0.8	V
Input High Level	V_{IH}		2.0	—	$V_{CC}+1$	V

● AC PROGRAMMING CHARACTERISTICS ($T_a=25^{\circ}C \pm 5^{\circ}C$, $V_{CC}=5V \pm 5\%$, $V_{PP}=25V \pm 1V$)

Parameter	Symbol	Test Condition	min.	typ.	max.	Unit
Address Setup Time	t_{AS}		2	—	—	μs
\overline{OE} Setup Time	t_{OES}		2	—	—	μs
Data Setup Time	t_{DS}		2	—	—	μs
Address Hold Time	t_{AH}		2	—	—	μs
\overline{OE} Hold Time	t_{OEH}		5	—	—	μs
Data Hold Time	t_{DH}		2	—	—	μs
\overline{OE} to Output Float Delay*	t_{DF}	$\overline{CE}=V_{IL}$	0	—	120	ns
\overline{OE} to Output Delay	t_{OE}	$\overline{CE}=V_{IL}$	—	—	120	ns
Program Pulse Width	t_{PW}		45	50	55	ms
Program Pulse Rise Time	t_{PRT}		5	—	—	ns
Program Pulse Fall Time	t_{PFT}		5	—	—	ns

Notes : V_{CC} must be applied simultaneously or before V_{PP} and removed simultaneously or after V_{PP} .

* : t_{DF} defines the time at which the output achieves the open circuit condition and is not referenced to output voltage levels.

● SWITCHING CHARACTERISTICS

Test Conditions

Input Pulse Level: 0.8V to 2.2V

Input Rise and Fall Times: ≤ 20 ns

Output Load: 1 TTL Gate + 100 pF

Reference Level for Measuring Timing:

Inputs: 1V and 2V, Outputs: 0.8V and 2V

● PROGRAMMING WAVEFORMS

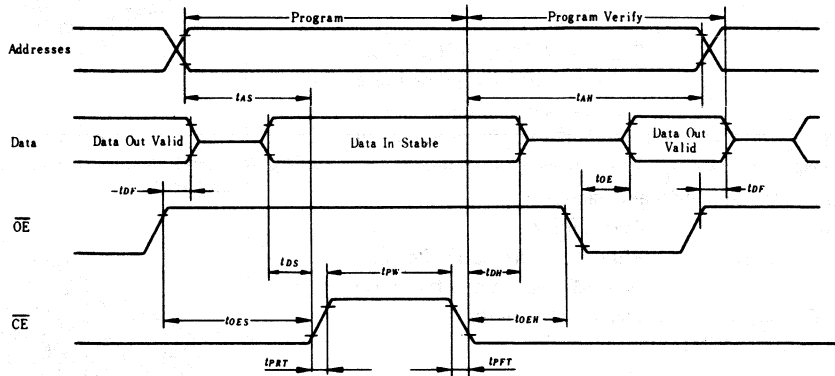

● ERASE

Erasure of HN462716 is performed by exposure to ultraviolet light with a wavelength of 2537Å, and all the output data are changed to "1" after this erasure procedure.

The minimum integrated dose (i.e., UV intensity x exposure time) for erasure is $15W \cdot sec/cm^2$

■ DEVICE OPERATION

● READ MODE

Dataout is available 450ns (t_{ACC}) from addresses with \overline{OE} low or 120ns (t_{OE}) from \overline{OE} with addresses stable.

● DESELECT MODE

The outputs may be OR-tied together with the other HN462716s. When HN462716s are deselected, the \overline{OE} inputs must be at high TTL level.

● POWER DOWN MODE

Power down is achieved with \overline{CE} high TTL level. In this mode the outputs are in a high impedance state.

● PROGRAMMING

Initially, and after each erasure, all bits of the HN462716 are in the "High" state (Output High). Data is introduced by selectively programming "low" into the desired bit locations. In the programming mode, V_{pp} power supply is at 25V and \overline{OE} input is at high TTL level. Data to be programmed are presented 8-bits in parallel, to the data output lines (O0 to O7).

The addresses and inputs are at TTL levels.

After the address and data setup, a 50 ms, active high program pulse is applied to the \overline{CE} input. The \overline{CE} is at TTL level.

The HN462716 must not be programmed with a DC signal applied to the \overline{CE} input.

● PROGRAM VERIFY

The HN462716 has a program verify mode. A verify should be performed on the programmed bits to determine that they were correctly programmed. In this mode V_{pp} is at 25V.

● PROGRAM INHIBIT

Programming of multiple HN462716s in parallel with different data is easily accomplished by using this mode. Except for \overline{CE} , all like inputs of the parallel HN462716s may be common.

A TTL program pulse applied to a HN462716's \overline{CE} input will program that HN462716. A low level \overline{CE} inhibits the other HN462716s from being programmed.

HN462532, HN462532G

4096-word × 8-bit U. V. Erasable and Programmable Read Only Memory

The HN462532 is a 4096 word by 8 bit erasable and electrically programmable ROM. This device is packaged in a 24-pin, dual-in-line package with transparent lid. The transparent lid allows the user to expose the chip to ultraviolet light to erase the bit pattern, whereby a new pattern can then be written into the device.

FEATURES

- Single Power Supply +5V ±5%
- Simple Programming Program Voltage: +25V D.C.
Program with One 50ms Pulse
- Static No Clocks Required
- Inputs and Outputs TTL Compatible During Both Read and Program Modes
- Fully Decoded On-Chip Address Decode
- Access Time 450ns (max.)
- Low Power Dissipation 858mW (max) Active Power
201mW (max) Standby Power
- Three Stste Output OR-Tie Capability
- Compatible with TMS2532

BLOCK DIAGRAM

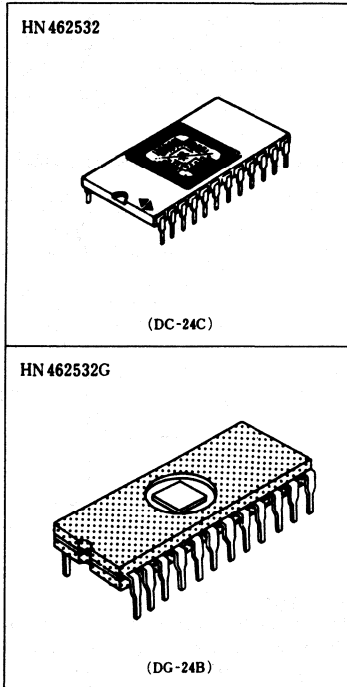
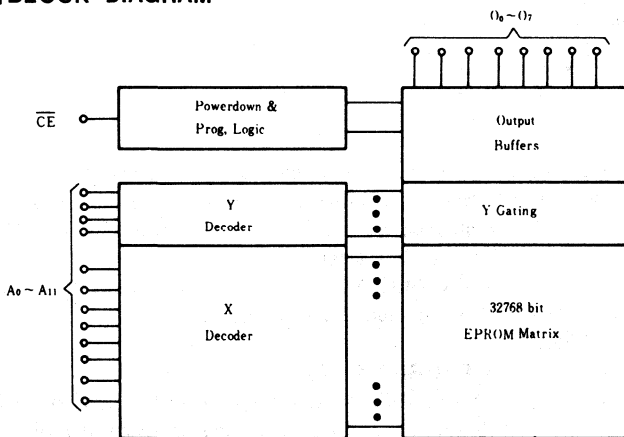

PIN ARRANGEMENT

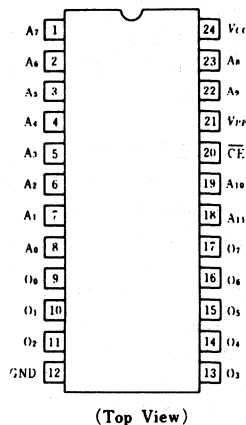

MODE SELECTION

Mode	Pins	\overline{CE} (20)	V_{PP} (21)	V_{CC} (24)	Outputs (9 to 11, 13 to 17)
Read		V_{IL}	+5	+5	Dout
Stand by		V_{IH}	+5	+5	High Z
Program		Pulsed V_{IH} to V_{IL}	+25	+5	Din
Program Inhibit		V_{IH}	+25	+5	High Z

■ ABSOLUTE MAXIMUM RATINGS

Item	Symbol	Value	Unit
All Input and Output Voltages*	V_T	-0.3 to +7	V
V_{PP} Voltage*	V_{PP}	-0.3 to +28	V
Operating Temperature Range	T_{opr}	0 to +70	°C
Storage Temperature Range	T_{stg}	-65 to +125	°C

* With respect to GND.

■ READ OPERATION

● DC AND OPERATING CHARACTERISTICS ($T_a=0$ to +70°C, $V_{CC}=5V \pm 5\%$, $V_{PP}=V_{CC} \pm 0.6V$)

Parameter	Symbol	Test Condition	min	typ	max	Unit
Input Leakage Current	I_{LI}	$V_{in} = 5.25V$	—	—	10	μA
Output Leakage Current	I_{LO}	$V_{out} = 5.25V / 0.4V$	—	—	10	μA
V_{PP} Current	I_{PP1}	$V_{PP} = 5.85V$	—	—	12	mA
V_{CC} Current (Standby)	I_{CC1}	$\overline{CE} = V_{IH}$	—	—	25	mA
V_{CC} Current (Active)	I_{CC2}	$\overline{CE} = V_{IL}$	—	—	150	mA
Input Low Voltage	V_{IL}		-0.1	—	0.8	V
Input High Voltage	V_{IH}		2.0	—	$V_{CC}+1$	V
Output Low Voltage	V_{OL}	$I_{OL} = 2.1mA$	—	—	0.4	V
Output High Voltage	V_{OH}	$I_{OH} = -400\mu A$	2.4	—	—	V

Note: V_{CC} must be applied simultaneously or before V_{PP} and removed simultaneously or after V_{PP} .

● AC CHARACTERISTICS ($T_a=0$ to +70°C, $V_{CC}=5V \pm 5\%$, $V_{PP}=V_{CC} \pm 0.6V$)

Parameter	Symbol	Test Condition	min	typ	max	Unit
Address to Output Delay	t_{ACC}	$\overline{CE} = V_{IL}$	—	—	450	ns
\overline{CE} to Output Delay	t_{CE}		—	—	450	ns
\overline{CE} High to Output Float*	t_{DF}		0	—	100	ns
Address to Output Hold	t_{OH}	$\overline{CE} = V_{IL}$	0	—	—	ns

*: t_{DF} defines the time at which the output achieves the open circuit condition and is not referenced to output voltage levels.

● SWITCHING CHARACTERISTICS

Test Conditions

Input Pulse Levels:	0.8V to 2.2V
Input Rise and Fall Times:	≤ 20 ns
Output Load:	1TTL Gate + 100pF
Reference Level for Measuring Timing:	Inputs; 1V and 2V, Outputs; 0.8V and 2V

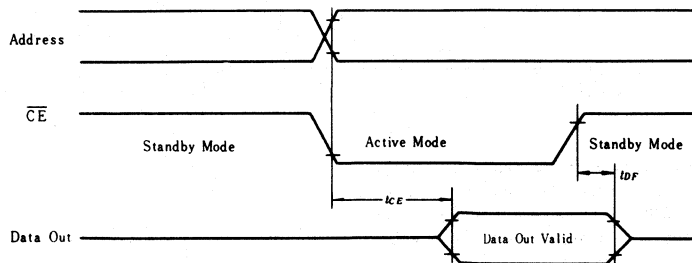

● CAPACITANCE ($T_a=25^\circ C$, $f=1MHz$)

Parameter	Symbol	Test Condition	min	typ	max	Unit
Input Capacitance	C_{in}	$V_{in} = 0V$	—	—	6	pF
Output Capacitance	C_{out}	$V_{out} = 0V$	—	—	12	pF

■ PROGRAMMING OPERATION

● DC PROGRAMMING CHARACTERISTICS ($T_a=25^{\circ}\text{C}\pm 5^{\circ}\text{C}$, $V_{CC}=5\text{V}\pm 5\%$, $V_{PP}=25\text{V}\pm 1\text{V}$)

Parameter	Symbol	Test Condition	min	typ	max	Unit
Input Leakage Current	I_{LL}	$V_{in}=5.25\text{V}/0.4\text{V}$	—	—	10	μA
V_{PP} Supply Current During Programming	I_{PP2}	$\overline{\text{CE}}=V_{LL}$	—	—	30	mA
V_{CC} Supply Current	I_{CC}		—	—	150	mA
Input Low Level	V_{LL}		-0.1	—	0.8	V
Input High Level	V_{HH}		2.0	—	$V_{CC}+1$	V

● AC PROGRAMMING CHARACTERISTICS ($T_a=25^{\circ}\text{C}\pm 5^{\circ}\text{C}$, $V_{CC}=5\text{V}\pm 5\%$, $V_{PP}=25\text{V}\pm 1\text{V}$)

Parameter	Symbol	Test Condition	min	typ	max	Unit
Address Setup Time	t_{AS}		2	—	—	μs
Data Setup Time	t_{DS}		2	—	—	μs
Address Hold Time	t_{AH}		2	—	—	μs
Data Hold Time	t_{DH}		2	—	—	μs
Setup Time from V_{PP}	t_{VPPS}		0	—	—	ns
Program Pulse Hold Time	t_{PRH}		0	—	—	ns
V_{PP} Hold Time	t_{VPPH}		0	—	—	ns
Program Pulse Width	t_{PW}		45	50	55	ms
Program Pulse Time	t_{PRT}		5	—	—	ns
Program Pulse Time	t_{PFT}		5	—	—	ns

Note: V_{CC} must be applied simultaneously or before V_{PP} and removed simultaneously or after V_{PP} .

● SWITCHING CHARACTERISTICS

Test Conditions

Input Pulse Level: 0.8V to 2.2V
 Input Rise and Fall Times: < 20 ns
 Output Load: 1TTL Gate + 100pF
 Reference Level for Measuring Timing: Inputs; 1V and 2V, Outputs; 0.8V and 2V

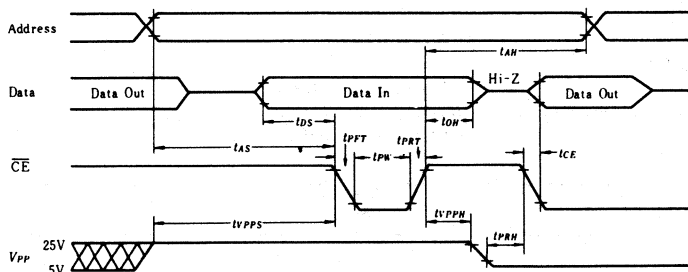

● ERASE

Erasure of HN462532 is performed by exposure to ultra-violet light with a wavelength of 2537Å, and all the output data are changed to "1" after this erasure procedure. The minimum integrated dose (i.e., UV intensity x exposure time) for erasure is $15\text{W} \cdot \text{sec}/\text{cm}^2$.

ACCESS TIME vs. SUPPLY VOLTAGE

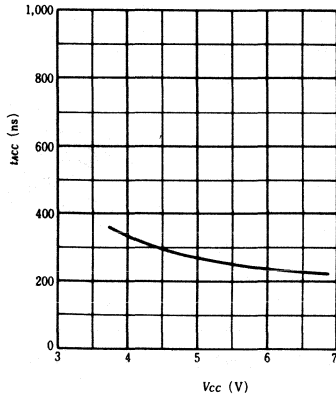

ACCESS TIME vs. AMBIENT TEMPERATURE

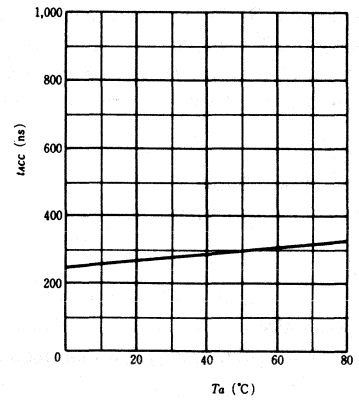

SUPPLY CURRENT vs. SUPPLY VOLTAGE

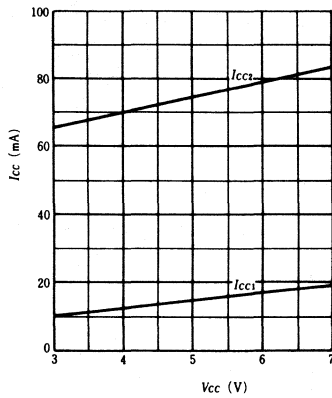

SUPPLY CURRENT vs. AMBIENT TEMPERATURE

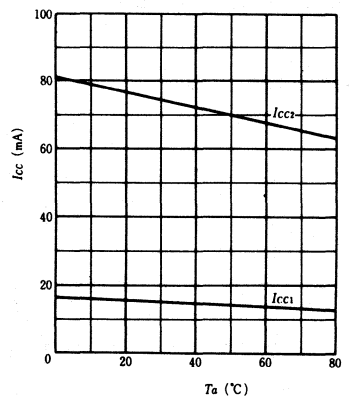

HN462732, HN462732G

4096-word × 8-bit U.V. Erasable and Programmable Read Only Memory

The HN462732 is a 4096 word by 8 bit erasable and electrically programmable ROM. This device is packaged in a 24-pin, dual-in-line package with transparent lid. The transparent lid allows the user to expose the chip to ultraviolet light to erase the bit pattern, whereby a new pattern can then be written into the device.

■ FEATURES

- Single Power Supply +5V ±5%
- Simple Programming Program Voltage: +25V D.C.
Program with One 50ms Pulse
- Static No Clocks Required
- Inputs and Outputs TTL Compatible During Both Read and Program Modes
- Fully Decoded On-Chip Address Decode
- Access Time 450ns (max)
- Low Power Dissipation 150mA (max) Active Currents
30mA (max) Standby Current
- Three State Output OR-Tie-Capability
- Compatible with INTEL 2732

■ BLOCK DIAGRAM

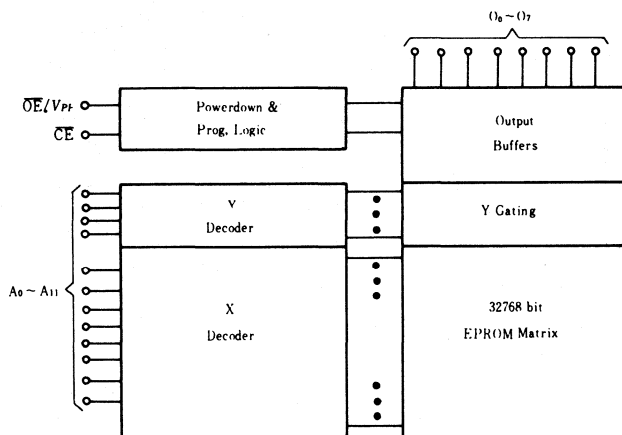

■ MODE SELECTION

Mode	Pins	\overline{CE} (18)	\overline{OE}/V_{PP} (20)	V_{CC} (24)	Outputs (9~11, 13~17)
Read		V_{IL}	V_{IL}	+5	Dout
Stand by		V_{IH}	Don't Care	+5	High Z
Program		V_{IL}	V_{PP}	+5	Din
Program Verify		V_{IL}	V_{IL}	+5	Dout
Program Inhibit		V_{IH}	V_{PP}	+5	High Z.

HN 462732

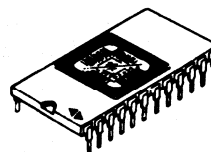

(DC-24C)

HN 462732G

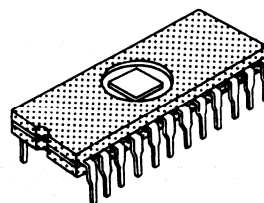

(DG-24B)

■ PIN ARRANGEMENT

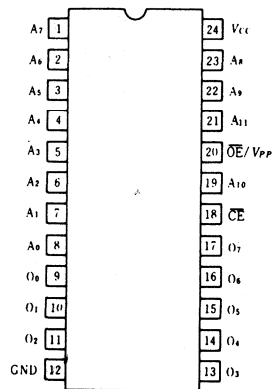

(Top View)

■ ABSOLUTE MAXIMUM RATINGS

Item	Symbol	Value	Unit
Operating Temperature Range	T_{opr}	0 to +70	°C
Storage Temperature Range	T_{stg}	-65 to +125	°C
All Input and Output Voltage*	V_T	-0.3 to +7	V
V_{PP} Voltage*	\overline{OE}/V_{PP}	-0.3 to +28	V

* With respect to GND

■ READ OPERATION

● DC AND OPERATING CHARACTERISTICS ($T_a=0$ to +70°C, $V_{CC}=5V \pm 5\%$, $V_{PP}=V_{CC} \pm 0.6V$)

Parameter	Symbol	Test Condition	min.	typ.	max.	Unit
Input Leakage Current (Except \overline{OE}/V_{PP})	I_{LI1}	$V_{IN}=5.25V$	—	—	10	μA
\overline{OE}/V_{PP} Input Leakage Current	I_{LI2}	$V_{IN}=5.25V$	—	—	10	μA
Output Leakage Current	I_{LO}	$V_{out}=5.25V$	—	—	10	μA
V_{CC} Current (Standby)	I_{CC1}	$\overline{CE}=V_{IH}, \overline{OE}=V_{IL}$	—	—	30	mA
V_{CC} Current (Active)	I_{CC2}	$\overline{OE}=\overline{CE}=V_{IL}$	—	—	150	mA
Input Low Voltage	V_{IL}		-0.1	—	0.8	V
Input High Voltage	V_{IH}		2.0	—	$V_{CC}+1$	V
Output Low Voltage	V_{OL}	$I_{OL}=2.1mA$	—	—	0.45	V
Output High Voltage	V_{OH}	$I_{OH}=-400\mu A$	2.4	—	—	V

● AC CHARACTERISTICS ($T_a=0$ to +70°C, $V_{CC}=5V \pm 5\%$, $V_{PP}=V_{CC} \pm 0.6V$)

Parameter	Symbol	Test Condition	min	typ	max	Unit
Address to Output Delay	t_{ACC}	$\overline{CE}=\overline{OE}=V_{IL}$	—	—	450	ns
\overline{CE} to Output Delay	t_{CE}	$\overline{OE}=V_{IL}$	—	—	450	ns
Output Enable to Output Delay	t_{OE}	$\overline{CE}=V_{IL}$	—	—	120	ns
Output Enable High to Output Float *	t_{DF}	$\overline{CE}=V_{IL}$	0	—	100	ns
Address to Output Hold	t_{OH}	$\overline{CE}=\overline{OE}=V_{IL}$	0	—	—	ns

* t_{DF} defines the time at which the output achieves the open circuit condition and is not referenced to output voltage levels.

● SWITCHING CHARACTERISTICS

Test Condition

- Input Pulse Levels: 0.8V to 2.2V
- Input Rise and Fall Times: $\leq 20ns$
- Output Load: 1TTL Gate + 100pF
- Reference Level for Measuring Timing: Inputs 1V and 2V, Outputs 0.8V and 2V

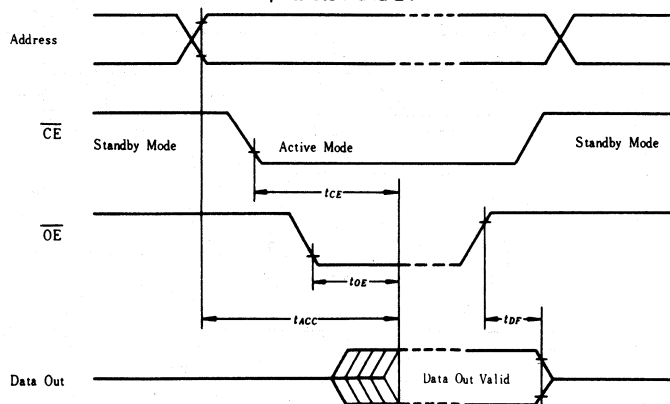

● CAPACITANCE ($T_a=25^\circ C$, $f=1MHz$)

Parameter	Symbol	Test Condition	min.	typ.	max.	Unit
Input Capacitance (Except \overline{OE}/V_{PP})	C_{NI}	$V_{IN}=0V$	—	—	6	pF
\overline{OE}/V_{PP} Input Capacitance	C_{N2}	$V_{IN}=0V$	—	—	20	pF
Output Capacitance	C_{out}	$V_{out}=0V$	—	—	12	pF

PROGRAMMING OPERATION

DC PROGRAMMING CHARACTERISTICS ($V_{CC}=5V \pm 5\%$, $V_{PP}=25V \pm 1V$, $T_a=25^\circ C \pm 5^\circ C$)

Parameter	Symbol	Test Condition	min.	typ.	max.	Unit
Input Leakage Current	I_{LI}	$V_{IN}=5.25V/0.4V$	—	—	10	μA
Output Low Voltage During Verify	V_{OL}	$I_{OL}=2.1mA$	—	—	0.4	V
Output High Voltage During Verify	V_{OH}	$I_{OH}=-400\mu A$	2.4	—	—	V
V_{CC} Supply Current	I_{CC}		—	—	150	mA
Input Low Level	V_{IL}		-0.1	—	0.8	V
Input High Level (All Input Except \overline{OE}/V_{PP})	V_{IH}		2.0	—	$V_{CC}+1$	V
V_{PP} Supply Current	I_{PP}	$\overline{CE}=V_{IL}, \overline{OE}=V_{PP}$	—	—	30	mA

AC PROGRAMMING CHARACTERISTICS ($V_{CC}=5V \pm 5\%$, $V_{PP}=25V \pm 1V$, $T_a=25^\circ C \pm 5^\circ C$)

Parameter	Symbol	Test Condition	min.	typ.	max.	Unit
Address Setup Time	t_{AS}		2	—	—	μs
\overline{OE} Setup Time	t_{OES}		2	—	—	μs
Data Setup Time	t_{DS}		2	—	—	μs
Address Hold Time	t_{AH}		0	—	—	μs
\overline{OE} Hold Time	t_{OEH}		2	—	—	μs
Data Hold Time	t_{DH}		2	—	—	μs
Chip Enable to Output Float Delay*	t_{DF}		0	—	120	ns
Data Valid from \overline{CE}	t_{DV}	$\overline{CE}=V_{IL}, \overline{OE}=V_{IL}$	—	—	1	μs
\overline{CE} Pulse Width During Programming	t_{PW}		45	50	55	ms
\overline{OE} Pulse Rise Time During Programming	t_{PRT}		50	—	—	ns
V_{PP} Recovery Time	t_{VR}		2	—	—	μs

* t_{DF} defines the time at which the output achieves the open circuit condition and is not referenced to output voltage levels.

SWITCHING CHARACTERISTICS

Test Conditions

- Input Pulse Level: 0.8V to 2.2V
- Input Rise and Fall Times: $\leq 20ns$
- Output Load: 1TTL Gate + 100pF
- Reference Level for Measuring Timing: Inputs; 1V and 2V, Outputs; 0.8V and 2V

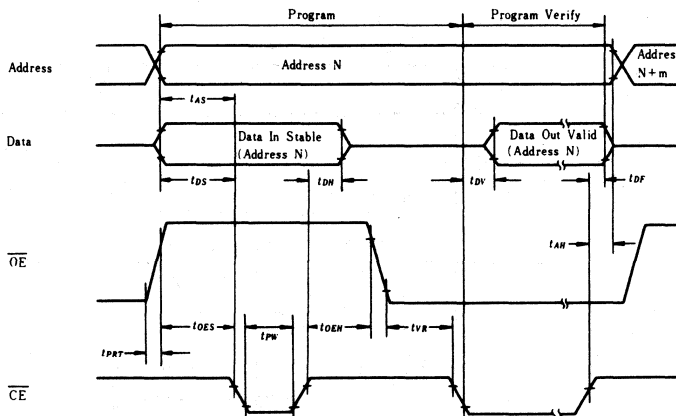

ERASE

Erasure of HN462732 is performed by exposure to Ultra-violet light of 2537Å, and all the output data are changed to "1" after this procedure.

The minimum integrated dose (i.e., UV intensity x exposure time) for erasure is $15W \cdot sec/cm^2$.

SUPPLY CURRENT vs. SUPPLY VOLTAGE

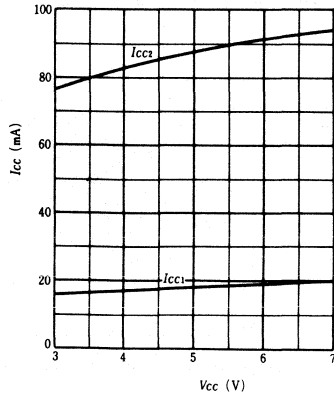

SUPPLY CURRENT vs. AMBIENT TEMPERATURE

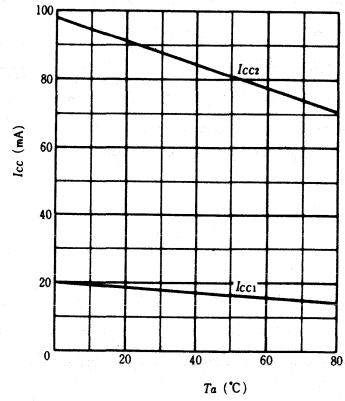

ACCESS TIME vs. SUPPLY VOLTAGE

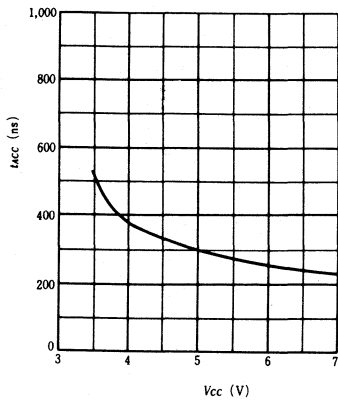

ACCESS TIME vs. AMBIENT TEMPERATURE

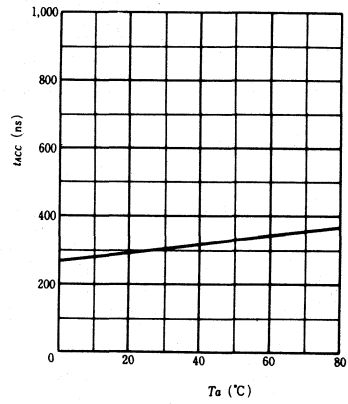

4096-word × 8-bit U.V. Erasable and Programmable Read Only Memory

The HN462732GI is a 4096 word by 8 bit erasable and electrically programmable ROM. This device is packaged in a 24-pin, dual-in-line package with transparent lid. The transparent lid allows the user to expose the chip to ultraviolet light to erase the bit pattern, whereby a new pattern can then be written into the device.

FEATURES

- Extended Operating Temperature Range $-40 \sim +85^{\circ}\text{C}$
- Single Power Supply $+5\text{V} \pm 5\%$
- Simple Programming Program Voltage: $+25\text{V D.C.}$
Program with One 50ms Pulse
- Static No Clocks Required
- Inputs and Outputs TTL Compatible During Both Read and Program Modes
- Fully Decoded On-Chip Address Decode
- Access Time 450ns (max)
- Low Power Dissipation 150mA (max) Active Currents
30mA (max) Standby Current
- Three State Output OR-Tie-Capability

BLOCK DIAGRAM

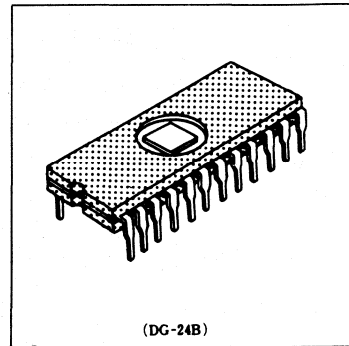
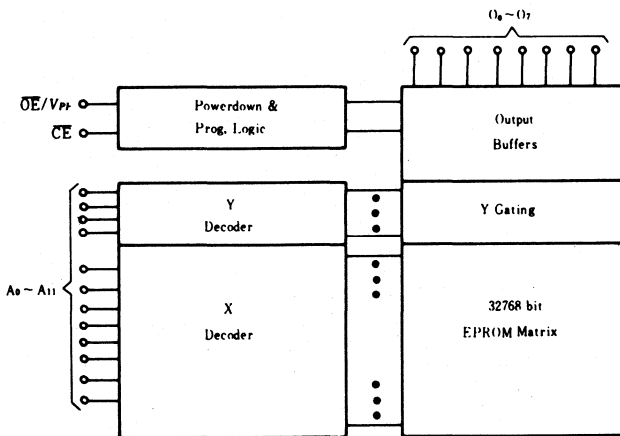

PIN ARRANGEMENT

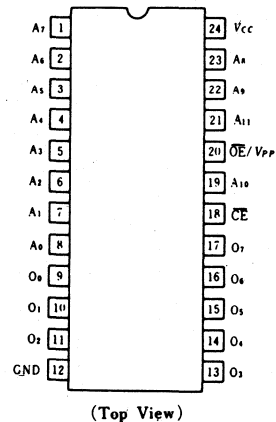

MODE SELECTION

Mode	Pins	CE (18)	OE/V _{PP} (20)	V _{CC} (24)	Outputs (9~11, 13~17)
Read		V _{IL}	V _{IL}	+5	Dout
Stand by		V _{IN}	Don't Care	+5	High Z
Program		V _{IL}	V _{PP}	+5	Din
Program Verify		V _{IL}	V _{IL}	+5	Dout
Program Inhibit		V _{IN}	V _{PP}	+5	High Z

■ ABSOLUTE MAXIMUM RATINGS

Item	Symbol	Value	Unit
Operating Temperature Range	T_{op}	-40 to +85	°C
Storage Temperature Range	T_{stg}	-65 to +125	°C
All Input and Output Voltage*	V_T	-0.3 to +7	V
V_{PP} Voltage*	\overline{OE}/V_{PP}	-0.3 to +28	V

* With respect to GND

■ READ OPERATION

● DC AND OPERATING CHARACTERISTICS ($T_a = -40$ to $+85^\circ\text{C}$, $V_{CC} = 5\text{V} \pm 5\%$)

Parameter	Symbol	Test Condition	min.	typ.	max.	Unit
Input Leakage Current (Except \overline{OE}/V_{PP})	I_{L1}	$V_{IN} = 5.25\text{V}$	—	—	10	μA
\overline{OE}/V_{PP} Input Leakage Current	I_{L2}	$V_{IN} = 5.25\text{V}$	—	—	10	μA
Output Leakage Current	I_{LO}	$V_{out} = 5.25\text{V}/0.45\text{V}$	—	—	10	μA
V_{CC} Current (Standby)	I_{CC1}	$\overline{CE} = V_{IH}, \overline{OE} = V_{IL}$	—	—	30	mA
V_{CC} Current (Active)	I_{CC2}	$\overline{OE} = \overline{CE} = V_{IL}$	—	—	150	mA
Input Low Voltage	V_{IL}		-0.1	—	0.8	V
Input High Voltage	V_{IH}		2.0	—	$V_{CC} + 1$	V
Output Low Voltage	V_{OL}	$I_{OL} = 2.1\text{mA}$	—	—	0.45	V
Output High Voltage	V_{OH}	$I_{OH} = -400\mu\text{A}$	2.4	—	—	V

● AC CHARACTERISTICS ($T_a = -40$ to $+85^\circ\text{C}$, $V_{CC} = 5\text{V} \pm 5\%$)

Parameter	Symbol	Test Condition	HN462732GI			Unit
			min.	typ.	max.	
Address to Output Delay	t_{ACC}	$\overline{CE} = \overline{OE} = V_{IL}$	—	—	450	ns
\overline{CE} to Output Delay	t_{CE}	$\overline{OE} = V_{IL}$	—	—	450	ns
Output Enable to Output Delay	t_{OE}	$\overline{CE} = V_{IL}$	—	—	150	ns
Output Enable High to Output Float*	t_{DF}	$\overline{CE} = V_{IL}$	0	—	130	ns
Address to Output Hold	t_{OH}	$\overline{CE} = \overline{OE} = V_{IL}$	0	—	—	ns

* t_{DF} defines the time at which the output achieves the open circuit condition and is not referenced to output voltage levels.

● SWITCHING CHARACTERISTICS

Test Condition

Input Pulse Levels: 0.8V to 2.2V

Input Rise and Fall Times: $\leq 20\text{ns}$

Output Load: 1TTL Gate + 100pF

Reference Level for Measuring Timing: Inputs 1V and 2V
Outputs 0.8V and 2V

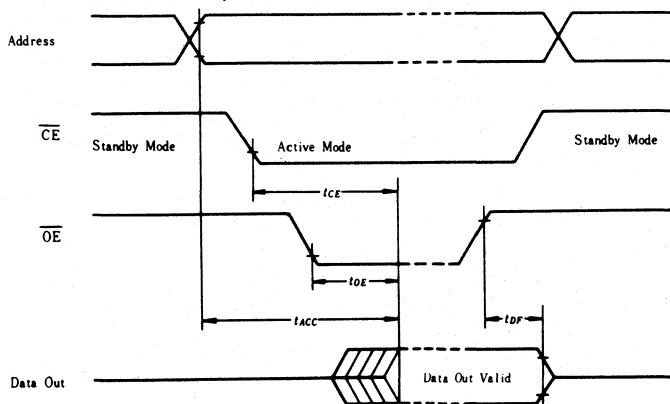

● CAPACITANCE ($T_a = 25^\circ\text{C}$, $f = 1\text{MHz}$)

Parameter	Symbol	Test Condition	min.	typ.	max.	Unit
Input Capacitance (Except \overline{OE}/V_{PP})	C_{N1}	$V_{IN} = 0\text{V}$	—	—	6	pF
\overline{OE}/V_{PP} Input Capacitance	C_{N2}	$V_{IN} = 0\text{V}$	—	—	20	pF
Output Capacitance	C_{out}	$V_{out} = 0\text{V}$	—	—	12	pF

■ PROGRAMMING OPERATION

● DC PROGRAMMING CHARACTERISTICS ($V_{CC}=5V \pm 5\%$, $V_{PP}=25V \pm 1V$, $T_a=25^\circ C \pm 5^\circ C$)

Parameter	Symbol	Test Condition	min.	typ.	max.	Unit
Input Leakage Current	I_{LI}	$V_{IN}=5.25V/0.4V$	—	—	10	μA
Output Low Voltage During Verify	V_{OL}	$I_{OL}=2.1mA$	—	—	0.4	V
Output High Voltage During Verify	V_{OH}	$I_{OH}=-400\mu A$	2.4	—	—	V
V_{CC} Supply Current	I_{CC}		—	—	150	mA
Input Low Level	V_{IL}		-0.1	—	0.8	V
Input High Level (All Input Except \overline{OE}/V_{PP})	V_{IH}		2.0	—	$V_{CC}+1$	V
V_{PP} Supply Current	I_{PP}	$\overline{CE}=V_{IL}, \overline{OE}=V_{PP}$	—	—	30	mA

● AC PROGRAMMING CHARACTERISTICS ($V_{CC}=5V \pm 5\%$, $V_{PP}=25V \pm 1V$, $T_a=25^\circ C \pm 5^\circ C$)

Parameter	Symbol	Test Condition	min.	typ.	max.	Unit
Address Setup Time	t_{AS}		2	—	—	μs
\overline{OE} Setup Time	t_{OES}		2	—	—	μs
Data Setup Time	t_{DS}		2	—	—	μs
Address Hold Time	t_{AH}		0	—	—	μs
\overline{OE} Hold Time	t_{OEH}		2	—	—	μs
Data Hold Time	t_{DH}		2	—	—	μs
Chip Enable to Output Float Delay*	t_{DF}		0	—	120	ns
Data Valid from \overline{CE}	t_{DV}	$\overline{CE}=V_{IL}, \overline{OE}=V_{IL}$	—	—	1	μs
\overline{CE} Pulse Width During Programming	t_{PW}		45	50	55	ms
\overline{OE} Pulse Rise Time During Programming	t_{PRT}		50	—	—	ns
V_{PP} Recovery Time	t_{VR}		2	—	—	μs

* t_{DF} defines the time at which the output achieves the open circuit condition and is not referenced to output voltage levels.

● SWITCHING CHARACTERISTICS

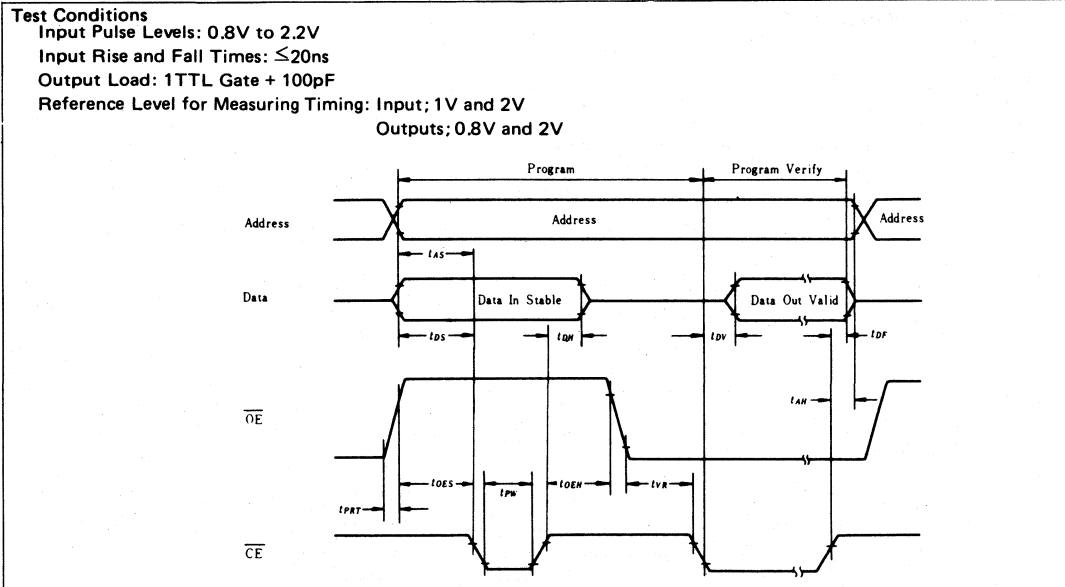

● ERASE

Erasure of HN462732 is performed by exposure to Ultra-violet light of 2537A, and all the output data are changed to "1" after this procedure.

The minimum integrated dose (i.e., UV intensity x exposure time) for erasure is $15W \cdot sec/cm^2$

HN482732AG-20, HN482732AG-25, HN482732AG-30

4096-word × 8-bit U. V. Erasable and Programmable Read Only Memory

The HN482732A is a 4096-word by 8-bit erasable and electrically programmable ROM. This device is packaged in a 24 pin dual-in-line package with transparent lid.

The transparent lid on the package allow the memory content to be erased with ultraviolet light.

FEATURES

- Single Power Supply +5V ±5%
- Simple Programming Program Voltage: +21V D.C.
Program with one 50ms Pulse
- Static No clocks Required
- Inputs and Outputs TTL Compatible During Both Read and Program Mode
- Access Time HN482732AG-20 200ns (max)
HN482732AG-25 250ns (max)
HN482732AG-30 300ns (max)
- Absolute Max. Rating of Vpp Pin . . . 26.5V
- Low Stand-by Current 35mA (max)
- Compatible with Intel 2732A

BLOCK DIAGRAM

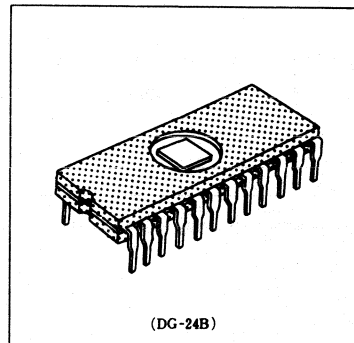
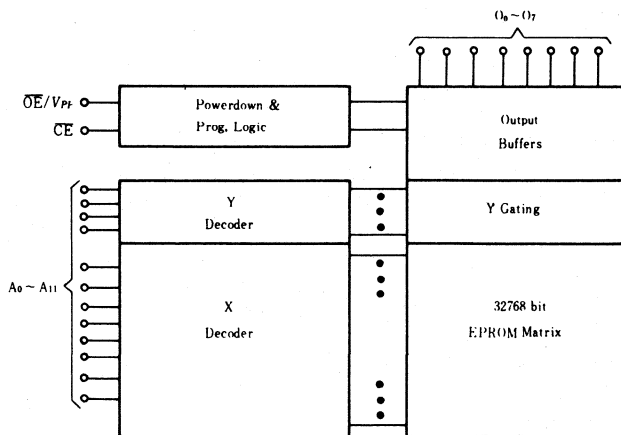

PIN ARRANGEMENT

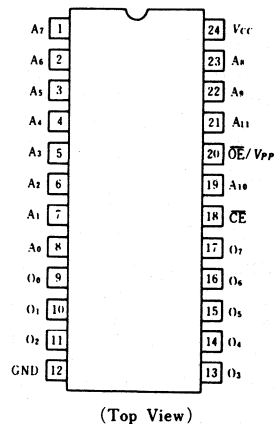

MODE SELECTION

MODE	Pins	\overline{CE} (18)	\overline{OE}/V_{PP} (20)	V_{CC} (24)	Outputs (9~11, 13~17)
Read		V_{IL}	V_{IL}	+5	D_{out}
Stand by		V_{IH}	Don't Care	+5	High Z
Program		V_{IL}	V_{PP}	+5	D_{in}
Program Verify		V_{IL}	V_{IL}	+5	D_{out}
Program Inhibit		V_{IH}	V_{PP}	+5	High Z

■ ABSOLUTE MAXIMUM RATINGS

Item	Symbol	Value	Unit
Operating Temperature Range	T_{opr}	0 to +70	°C
Storage Temperature Range	T_{stg}	-65 to +125	°C
All Input and Output Voltages*	V_{in}, V_{out}	-0.3 to +7	V
V_{PP} Voltage*	\overline{OE}/V_{PP}	-0.3 to +26.5	V
V_{CC} Voltage*	V_{CC}	-0.3 to +7	V

* with respect to GND

■ READ OPERATION

● D.C. AND OPERATING CHARACTERISTICS ($T_a=0$ to 70°C , $V_{CC}=5\text{V}\pm 5\%$)

Parameter	Symbol	Test Conditions	min	typ	max	Unit
Input Leakage Current	I_{LI}	$V_{IN}=5.25\text{V}$	—	—	10	μA
Output Leakage Current	I_{LO}	$V_{out}=5.25\text{V}$	—	—	10	μA
V_{CC} Current (Standby)	I_{CC1}	$\overline{CE}=V_{IH}, \overline{OE}=V_{IL}$	—	—	35	mA
V_{CC} Current (Active)	I_{CC2}	$\overline{OE}=\overline{CE}=V_{IL}$	—	—	150	mA
Input Low Voltage	V_{IL}		-0.1	—	0.8	V
Input High Voltage	V_{IH}		2.0	—	$V_{CC}+1$	V
Output Low Voltage	V_{OL}	$I_{OL}=2.1\text{mA}$	—	—	0.45	V
Output High Voltage	V_{OH}	$I_{OH}=-400\mu\text{A}$	2.4	—	—	V

● AC CHARACTERISTICS ($T_a=0$ to 70°C , $V_{CC}=5\text{V}\pm 5\%$)

Parameter	Symbol	Test Conditions	HN482732AG-20		HN482732AG-25		HN482732AG-30		Unit
			min	max	min	max	min	max	
Address to Output Delay	t_{ACC}	$\overline{CE}=\overline{OE}=V_{IL}$	—	200	—	250	—	300	ns
\overline{CE} to Output Delay	t_{CE}	$\overline{OE}=V_{IL}$	—	200	—	250	—	300	ns
\overline{OE} to Output Delay	t_{OE}	$\overline{CE}=V_{IL}$	10	90	10	100	10	150	ns
\overline{OE} High to Output Float	t_{DF}	$\overline{CE}=V_{IL}$	0	80	0	90	0	130	ns
Address to Output Hold	t_{OH}	$\overline{CE}=\overline{OE}=V_{IL}$	0	—	0	—	0	—	ns

● SWITCHING CHARACTERISTICS

Test Conditions

Input Pulse Level: 0.8V to 2.2V

Input Rise and Fall Times: $\leq 20\text{ns}$

Output Load: 1 TTL Gate + 100PF

Reference Level for Measuring Timing Inputs, 1V and 2V, Outputs; 0.8V and 2V

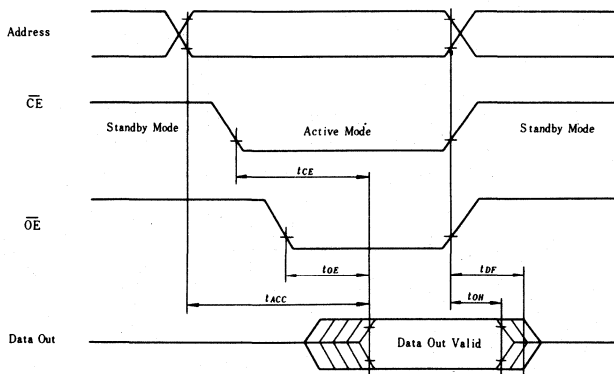

● CAPACITANCE ($T_a=25^\circ\text{C}$, $f=1\text{MHz}$)

Parameter	Symbol	Test Conditions	min	typ	max	Unit
Input Capacitance (Except \overline{OE}/V_{PP})	C_{IN1}	$V_{IN}=0\text{V}$	—	—	6	pF
\overline{OE}/V_{PP} Input Capacitance	C_{IN2}	$V_{IN}=0\text{V}$	—	—	20	pF
Output Capacitance	C_{out}	$V_{out}=0\text{V}$	—	—	12	pF

■ PROGRAMMING OPERATION

● DC PROGRAMMING CHARACTERISTICS ($T_a=25^\circ\text{C}\pm 5^\circ\text{C}$, $V_{CC}=5\text{V}\pm 5\%$, $V_{PP}=21\text{V}\pm 0.5\text{V}$)

Parameter	Symbol	Test Condition	min	typ	max	Unit
Input Leakage Current	I_{LI}	$V_{IN}=V_{IL}$ or V_{IH}	—	—	10	μA
Output Low Voltage During Verify	V_{OL}	$I_{OL}=2.1\text{mA}$	—	—	0.4	V
Output High Voltage During Verify	V_{OH}	$I_{OH}=-400\mu\text{A}$	2.4	—	—	V
V_{CC} Supply Current	I_{CC}		—	—	150	mA
Input Low Level	V_{IL}		-0.1	—	0.8	V
Input High Level (All Inputs Except $\overline{\text{OE}}/V_{PP}$)	V_{IH}		2.0	—	$V_{CC}+1$	V
V_{PP} Supply Current	I_{PP}	$\overline{\text{CE}}=V_{IL}$, $\overline{\text{OE}}=V_{PP}$	—	—	30	mA

● AC PROGRAMMING CHARACTERISTICS ($T_a=25^\circ\text{C}\pm 5^\circ\text{C}$, $V_{CC}=5\text{V}\pm 5\%$, $V_{PP}=21\text{V}\pm 0.5\text{V}$)

Parameter	Symbol	Test Conditions	min	typ	max	Unit
Address Setup Time	t_{AS}		2	—	—	μs
$\overline{\text{OE}}$ Setup Time	t_{OES}		2	—	—	μs
Data Setup Time	t_{DS}		2	—	—	μs
Address Hold Time	t_{AH}		0	—	—	μs
$\overline{\text{OE}}$ Hold Time	t_{OEH}		2	—	—	μs
Data Hold Time	t_{DH}		2	—	—	μs
Chip Enable to Output Float Delay*	t_{DF}		0	—	130	ns
Data Valid from $\overline{\text{CE}}$	t_{DV}	$\overline{\text{CE}}=V_{IL}$, $\overline{\text{OE}}=V_{IL}$	—	—	1	μs
$\overline{\text{CE}}$ Pulse Width During Programming	t_{PW}		45	50	55	ms
$\overline{\text{OE}}$ Pulse Rise Time During Programming	t_{PRT}		50	—	—	ns
V_{PP} Recovery Time	t_{VR}		2	—	—	μs

* t_{DF} defines the time at which the output achieves the open circuit condition and is not referenced to output voltage levels.

● SWITCHING CHARACTERISTICS

Test Condition

Input Pulse Level 0.8V to 2.2V

Input Rise and Fall Time $\leq 20\text{ns}$

Reference Level for Measuring Timing: Inputs 1V and 2V; Outputs 0.8V and 2V

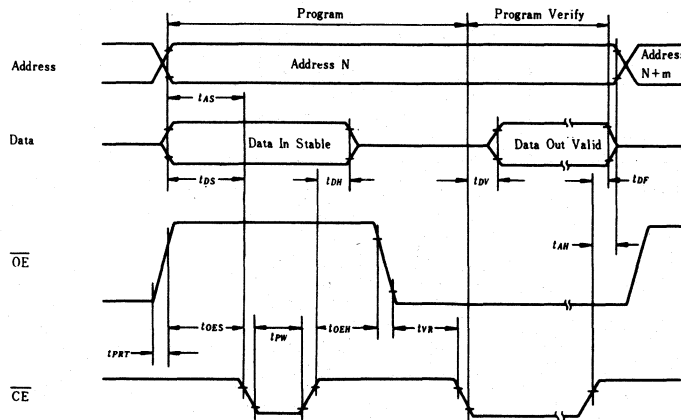

● ERASE

Erasure of HN482732A is performed by exposure to ultraviolet light of 2537Å and all the output data are changed to "1" after this erasure procedure. The minimum integrated dose (i.e. UV intensity x exposure time) for erasure is 15W-sec/cm².

HN482764, HN482764-3, HN482764-4, HN482764G, HN482764G-3, HN482764G-4

8192-word × 8-bit U. V. Erasable and Programmable Read Only Memory

The HN482764 is a 8192 word by 8 bit erasable and electrically programmable ROM. This device is packaged in a 28 pin dual-in-line package with transparent lid. The transparent lid on the package allows the memory content to be erased with ultraviolet light.

FEATURES

- Single Power Supply +5V ± 5%
- Simple Programming Program Voltage: +21V D.C.
Program with one 50ms Pulse
- Static No Clocks Required
- Inputs and Outputs TTL Compatible During Both Read and Program Mode.
- Access Time HN482764/G 250ns max
HN482764/G-3 300ns max
HN482764/G-4 450ns max
- High Performance Programming Available
- Low Standby Current 35mA max.
- Compatible with Intel 2764

BLOCK DIAGRAM

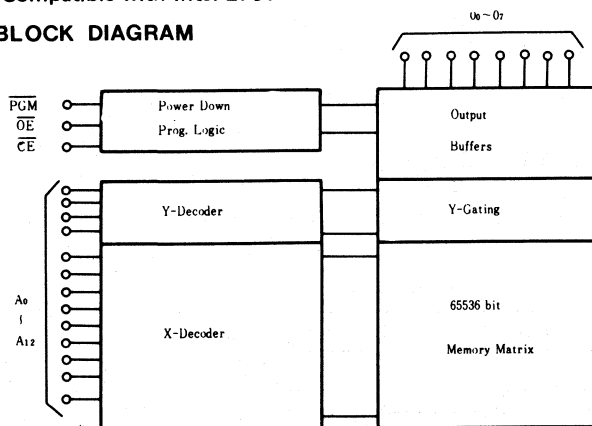

MODE SELECTION

Mode	Pins	CE (20)	OE (22)	PGM (27)	V _{PP} (1)	V _{CC} (28)	Outputs (11~13, 15~19)
Read		V _{IL}	V _{IL}	V _{IH}	V _{CC}	V _{CC}	Dout
Stand-by		V _{IH}	×	×	V _{CC}	V _{CC}	High Z
Program		V _{IL}	×	V _{IL}	V _{PP}	V _{CC}	Din
Program Verify		V _{IL}	V _{IL}	V _{IH}	V _{PP}	V _{CC}	Dout
Program Inhibit		V _{IH}	×	×	V _{PP}	V _{CC}	High Z

× : don't care

ABSOLUTE MAXIMUM RATINGS

Item	Symbol	Value	Unit
Operating Temperature Range	T _{opr}	0 to +70	°C
Storage Temperature Range	T _{stg}	-65 to +125	°C
All Input and Output Voltage*	V _T	-0.3 to +7	V
V _{PP} Voltage	V _{PP}	-0.3 to +26.5	V

* : with respect to GND

HN482764, HN482764-3, HN482764-4

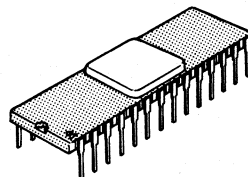

(DC-28B)

HN482764G, HN482764G-3,
HN482764G-4

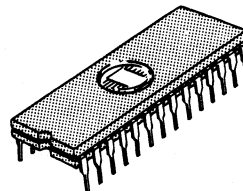

(DG-28)

PIN ARRANGMENT

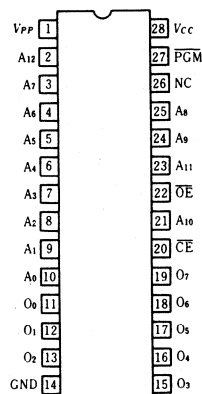

(Top View)

■ READ OPERATION

● DC AND OPERATING CHARACTERISTICS ($T_a=0$ to $+70^\circ\text{C}$, $V_{CC}=5\text{V}\pm 5\%$, $V_{PP}=V_{CC}\pm 0.6\text{V}$)

Parameter	Symbol	Test Condition	min	typ	max	Unit
Input Leakage Current	I_{LI}	$V_{CC}=5.25\text{V}$, $V_{in}=5.25\text{V}$	—	—	10	μA
Output Leakage Current	I_{LO}	$V_{CC}=5.25\text{V}$, $V_{out}=5.25\text{V}/0.4\text{V}$	—	—	10	μA
V_{PP} Current	I_{PP1}	$V_{PP}=V_{CC}+0.6\text{V}$	—	—	15	mA
V_{CC} Current (Standby)	I_{CC1}	$\overline{\text{CE}}=V_{IH}$	—	—	35	mA
V_{CC} Current (Active)	I_{CC2}	$\overline{\text{CE}}=\overline{\text{OE}}=V_{IL}$	—	100	150	mA
Input Low Voltage	V_{IL}		-0.1	—	0.8	V
Input High Voltage	V_{IH}		2.0	—	$V_{CC}+1$	V
Output Low Voltage	V_{OL}	$I_{OL}=2.1\text{mA}$	—	—	0.45	V
Output High Voltage	V_{OH}	$I_{OH}=-400\mu\text{A}$	2.4	—	—	V

● AC CHARACTERISTICS ($T_a=0$ to $+70^\circ\text{C}$, $V_{CC}=5\text{V}\pm 5\%$, $V_{PP}=V_{CC}\pm 0.6\text{V}$)

Parameter	Symbol	Test Conditions	HN482764/G		HN482764/G-3		HN482764/G-4		Unit
			min	max	min	max	min	max	
Address to Output Delay	t_{ACC}	$\overline{\text{CE}}=\overline{\text{OE}}=V_{IL}$	—	250	—	300	—	450	ns
$\overline{\text{CE}}$ to Output Delay	t_{CE}	$\overline{\text{OE}}=V_{IL}$	—	250	—	300	—	450	ns
$\overline{\text{OE}}$ to Output Delay	t_{OE}	$\overline{\text{CE}}=V_{IL}$	10	100	10	150	10	150	ns
$\overline{\text{OE}}$ High to Output Float	t_{DF}	$\overline{\text{CE}}=V_{IL}$	0	90	0	130	0	130	ns
Address to Output Hold	t_{OH}	$\overline{\text{CE}}=\overline{\text{OE}}=V_{IL}$	0	—	0	—	0	—	ns

Note: t_{OH} defines the time at which the output achieves the open circuit condition and is not referenced to output voltage levels

● SWITCHING CHARACTERISTICS
Test Condition

Input Pulse Levels: 0.8V to 2.2V
 Input Rise and Fall Time: $\leq 20\text{ns}$
 Output Load: 1TTL Gate + 100pF
 Reference Level for Measuring Timing: Inputs; 1V and 2V
 Output; 0.8V and 2.0V

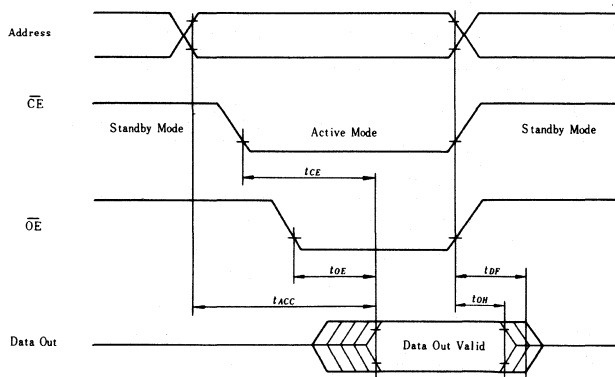

● CAPACITANCE ($T_a=25^\circ\text{C}$, $f=1\text{MHz}$)

Parameter	Symbol	Test Condition	min	typ	max	Unit
Input Capacitance	C_{in}	$V_{in}=0\text{V}$	—	4	6	pF
Output Capacitance	C_{out}	$V_{out}=0\text{V}$	—	8	12	pF

PROGRAMMING OPERATION

DC PROGRAMMING CHARACTERISTICS ($T_a=25^\circ\text{C} \pm 5^\circ\text{C}$, $V_{CC}=5\text{V} \pm 5\%$, $V_{PP}=21\text{V} \pm 0.5\text{V}$)

Parameter	Symbol	Test Condition	min	typ	max	Unit
Input Leakage Current	I_{LI}	$V_{i_s} = 5.25\text{V}$	—	—	10	μA
Output Low Voltage During Verify	V_{OL}	$I_{OL} = 2.1\text{mA}$	—	—	0.45	V
Output High Voltage During Verify	V_{OH}	$I_{OH} = -400\mu\text{A}$	2.4	—	—	V
V_{CC} Current (Active)	I_{CC2}		—	—	150	mA
Input Low Level	V_{IL}		-0.1	—	0.8	V
Input High Level	V_{IH}		2.0	—	$V_{CC} + 1$	V
V_{PP} Supply Current	I_{PP}	$\overline{\text{CE}} = \overline{\text{PGM}} = V_{IL}$	—	—	30	mA

AC PROGRAMMING CHARACTERISTICS ($T_a=25^\circ\text{C} \pm 5^\circ\text{C}$, $V_{CC}=5\text{V} \pm 5\%$, $V_{PP}=21\text{V} \pm 0.5\text{V}$)

Parameter	Symbol	Test Condition	min	typ	max	Unit
Address Setup Time	t_{AS}		2	—	—	μs
OE Setup Time	t_{OES}		2	—	—	μs
Data Setup Time	t_{DS}		2	—	—	μs
Address Hold Time	t_{AH}		0	—	—	μs
Data Hold Time	t_{DH}		2	—	—	μs
OE to Output Float Delay	t_{DF}		0	—	130	ns
V_{PP} Setup Time	t_{VS}		2	—	—	μs
PGM Pulse Width During Programming	t_{PW}		45	50	55	ms
CE Setup Time	t_{CES}		2	—	—	μs
Data Valid from OE	t_{OE}		—	—	150	ns

Note: t_{DF} defines the time at which the output achieves the open circuit condition and is not referenced to output voltage levels.

SWITCHING CHARACTERISTICS

Test Condition

Input Pulse Level: 0.8V to 2.2V
 Input Rise and Fall Time: $\leq 20\text{ns}$
 Reference Level for Measuring Timing: Input; 1V and 2V
 Output; 0.8V and 2V

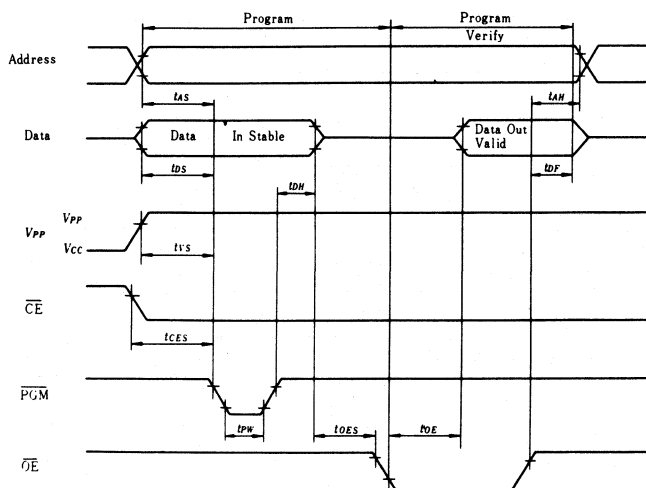

ERASE

Erasure of HN482764 is performed by exposure to Ultra-violet light of 2537Å, and all the output data are changed to "1" after this erasure procedure. The minimum integrated dose (i.e. UV intensity x exposure time) for erasure is $15\text{W} \cdot \text{sec}/\text{cm}^2$

HIGH PERFORMANCE PROGRAMMING

This device can be applied the High Performance Programming algorithm shown in following flowchart. This algorithm allows to obtain faster programming time without any voltage stress to the device nor deterioration in reliability of programmed data.

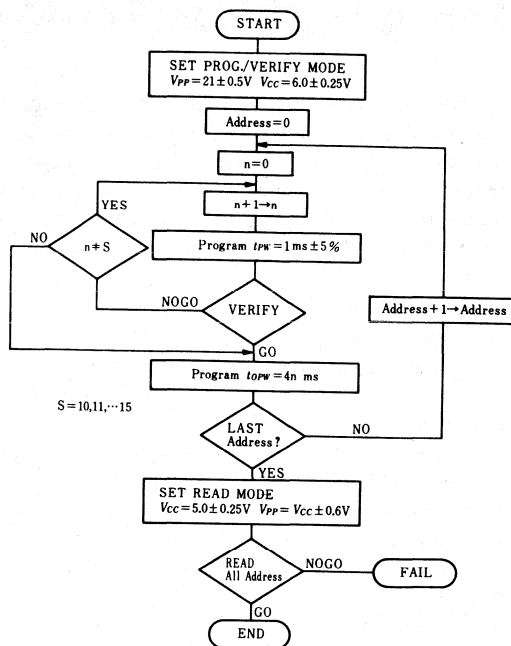

High Performance Programming Flowchart

AC PROGRAMMING CHARACTERISTICS (Ta=25°C±5°C, Vcc=6V±0.25V, Vpp=21V±0.5V)

Parameter	Symbol	Test Condition	min	typ	max	Unit
Address Setup Time	t_{AS}		2	—	—	μs
\overline{OE} Setup Time	t_{OES}		2	—	—	μs
Data Setup Time	t_{DS}		2	—	—	μs
Address Hold Time	t_{AH}		0	—	—	μs
Data Hold Time	t_{DH}		2	—	—	μs
\overline{OE} to Output Float Delay *	t_{OF}		0	—	130	ns
Vpp Setup Time	t_{VPS}		2	—	—	μs
Vcc Setup Time	t_{VCS}		2	—	—	μs
PGM Pulse Width during Initial Program	t_{PW}		0.95	1.0	1.05	ms
PGM Pulse Width during Oyer Program**	t_{OPW}		3.8	—	63	ms
CE Setup Time	t_{CES}		2	—	—	μs
Data Valid from \overline{OE}	t_{OE}		—	—	150	ns

Notes) * t_{DF} defines the time at which the output achieves the open circuit condition and is not referenced to output voltage levels.
** t_{OPW} is defined as mentioned in flort chart.

SWITCHING CHARACTERISTICS

Test Condition

Input Pulse Level: 0.8V to 2.2V
 Input Rise and Fall Time: ≤ 20 ns
 Reference Level for Measuring Timing: Input; 1V and 2V
 Output; 0.8V and 2V

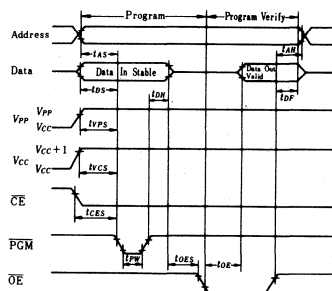

HN4827128G-25, HN4827128G-30, HN4827128G-45

Preliminary

16384-Word x 8-bit UV Erasable and Programmable Read Only Memory

The HN4827128 is a 16384 word by 8 bit erasable and electrically programmable ROM. This device is packaged in a dual-in-line package with transparent lid. The transparent lid allows the user to expose the chip to ultraviolet light to erase the bit pattern, whereby a new pattern can then be written into the device.

FEATURES

- Single Power Supply +5V ± 5%
- Simple Programming Program Voltage: +21V DC
Program with One 50ms Pulse
- Static No Clocks Required
Inputs and Outputs TTL Compatible During Both Read and Program Mode.
- Access Time 250ns/300ns/450ns
- Absolute Max. Rating of Vpp Pin 26.5V
- Low Stand-by Current 35mA
- High Performance Programming Available
- Compatible with INTEL 27128

BLOCK DIAGRAM

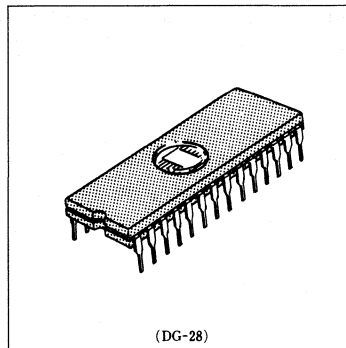
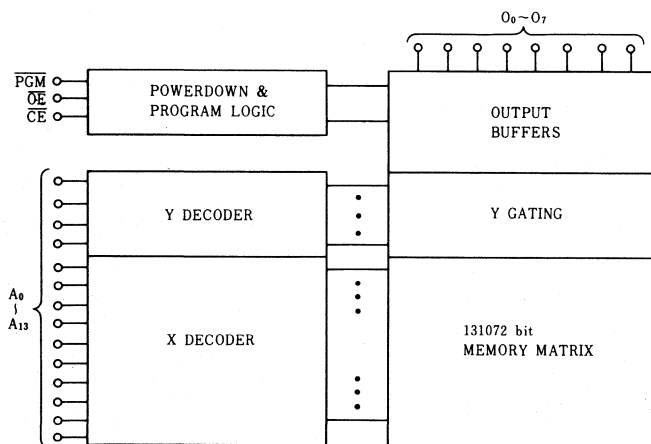

PIN ARRANGEMENT

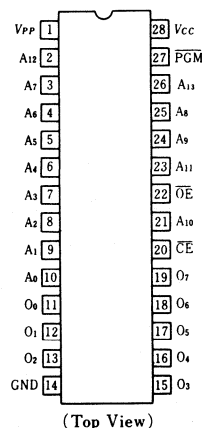

MODE SELECTION

MODE	Pins	CE (20)	OE (22)	PGM (27)	Vpp (1)	Vcc (28)	Outputs (11~13, 15~19)
Read		V _{IL}	V _{IL}	V _{IH}	V _{CC}	V _{CC}	Dout
Stand by		V _{IH}	×	×	V _{CC}	V _{CC}	High Z
Program		V _{IL}	×	V _{IL}	V _{PP}	V _{CC}	Din
Program Verify		V _{IL}	V _{IL}	V _{IH}	V _{PP}	V _{CC}	Dout
Program Inhibit		V _{IH}	×	×	V _{PP}	V _{CC}	High Z

Note) The specifications of this device are subject to change without notice.
Please contact your nearest Hitachi's Sales Dept. regarding specifications.

■ ABSOLUTE MAXIMUM RATINGS

Item	Symbol	Value	Unit
Operating Temperature Range	T_{opr}	0 to +70	°C
Storage Temperature Range	T_{stg}	-65 to +125	°C
All Input and Output Voltages*	V_{IN}, V_{out}	-0.3 to +7	V
V_{PP} Voltage*	V_{PP}	-0.3 to +26.5	V
V_{CC} Voltage*	V_{CC}	-0.3 to +7	V

* with respect to GND

■ READ OPERATION

● DC AND OPERATING CHARACTERISTICS ($T_a=0$ to +70°C, $V_{CC}=5V \pm 5\%$, $V_{PP}=V_{CC} \pm 0.6V$)

Parameter	Symbol	Test Conditions	min	typ	max	Unit
Input Leakage Current	I_{LI}	$V_{CC}=5.25V, V_{IN}=5.25V$	—	—	10	μA
Output Leakage Current	I_{LO}	$V_{CC}=5.25V, V_{out}=5.25V/0.4V$	—	—	10	μA
V_{PP} Current	I_{PP1}	$V_{PP}=V_{CC}+0.6V$	—	—	5	mA
V_{CC} Current (Standby)	I_{CC1}	$\overline{CE}=V_{IH}$	—	—	35	mA
V_{CC} Current (Active)	I_{CC2}	$\overline{CE}=\overline{OE}=V_{IL}$	—	60	100	mA
Input Low Voltage	V_{IL}		-0.1	—	0.8	V
Input High Voltage	V_{IH}		2.0	—	$V_{CC}+1$	V
Output Low Voltage	V_{OL}	$I_{OL}=2.1mA$	—	—	0.45	V
Output High Voltage	V_{OH}	$I_{OH}=-400\mu A$	2.4	—	—	V

● AC CHARACTERISTICS ($T_a=0$ to 70°C, $V_{CC}=5V \pm 5\%$, $V_{PP}=V_{CC} \pm 0.6V$)

Parameter	Symbol	Test Condition	HN4827128G-25		HN4827128G-30		HN4827128G-45		Unit
			min	max	min	max	min	max	
Address to Output Delay	t_{ACC}	$\overline{CE}=\overline{OE}=V_{IL}$	—	250	—	300	—	450	ns
\overline{CE} to Output Delay	t_{CE}	$\overline{OE}=V_{IL}$	—	250	—	300	—	450	ns
\overline{OE} to Output Delay	t_{OE}	$\overline{CE}=V_{IL}$	—	100	—	120	—	150	ns
\overline{OE} High to Output Float	t_{DF}	$\overline{CE}=V_{IL}$	0	85	0	105	0	130	ns
Address to Output Hold	t_{OH}	$\overline{CE}=\overline{OE}=V_{IL}$	0	—	0	—	0	—	ns

* t_{DF} defines the time at which the output achieves the open circuit condition and is not referenced to output voltage levels.

● SWITCHING CHARACTERISTICS

Test Condition

Input Pulse Levels: 0.8V to 2.2V
 Input Rise and Fall Time: ≤ 20 ns
 Output Load: 1 TTL Gate + 100 pF
 Reference Level for Measuring Timing: Inputs; 1V and 2V
 Outputs; 0.8V and 2.0V

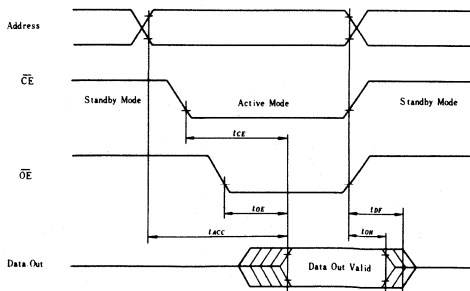

● CAPACITANCE ($T_a=25^\circ C, f=1$ MHz)

Parameter	Symbol	Test Condition	min	typ	max	Unit
Input Capacitance	C_{in}	$V_{in}=0V$	—	4	6	pF
Output Capacitance	C_{out}	$V_{out}=0V$	—	8	12	pF

PROGRAMMING OPERATION

DC PROGRAMMING CHARACTERISTICS ($T_a=25^{\circ}\text{C}\pm 5^{\circ}\text{C}$, $V_{CC}=5\text{V}\pm 5\%$, $V_{PP}=21\text{V}\pm 0.5\text{V}$)

Parameter	Symbol	Test Condition	min	typ	max	Unit
Input Leakage Current	I_{LI}	$V_{IN}=5.25\text{V}$	—	—	10	μA
Output Low Voltage During Verify	V_{OL}	$I_{OL}=2.1\text{mA}$	—	—	0.45	V
Output High Voltage During Verify	V_{OH}	$I_{OH}=-400\mu\text{A}$	2.4	—	—	V
V_{CC} Current (Active)	I_{CC2}		—	—	100	mA
Input Low Level	V_{IL}		-0.1	—	0.8	V
Input High Level	V_{IH}		2.0	—	$V_{CC}+1$	V
V_{PP} Supply Current	I_{PP}	$\overline{\text{CE}}=\overline{\text{PGM}}=V_{IL}$	—	—	30	mA

AC PROGRAMMING CHARACTERISTICS ($T_a=25^{\circ}\text{C}\pm 5^{\circ}\text{C}$, $V_{CC}=5\text{V}\pm 5\%$, $V_{PP}=21\text{V}\pm 0.5\text{V}$)

Parameter	Symbol	Test Condition	min	typ	max	Unit
Address Setup Time	t_{AS}		2	—	—	μs
OE Setup Time	t_{OES}		2	—	—	μs
Data Setup Time	t_{DS}		2	—	—	μs
Address Hold Time	t_{AH}		0	—	—	μs
Data Hold Time	t_{DH}		2	—	—	μs
OE to Output Float Delay	t_{DF}		0	—	130	ns
V_{PP} Setup Time	t_{VS}		2	—	—	μs
PGM Pulse Width During Programming	t_{PW}		45	50	55	ms
CE Setup Time	t_{CES}		2	—	—	μs
Data Valid from $\overline{\text{OE}}$	t_{OE}		—	—	150	ns

Note: t_{DF} defines the time at which the output achieves the open circuit condition and is not referenced to output voltage levels.

SWITCHING CHARACTERISTICS

Test Condition

- Input Pulse Level: 0.8V to 2.2V
- Input Rise and Fall Time: $\leq 20\text{ ns}$
- Reference Level for Measuring Timing: Input; 1V and 2V
Output; 0.8V and 2V

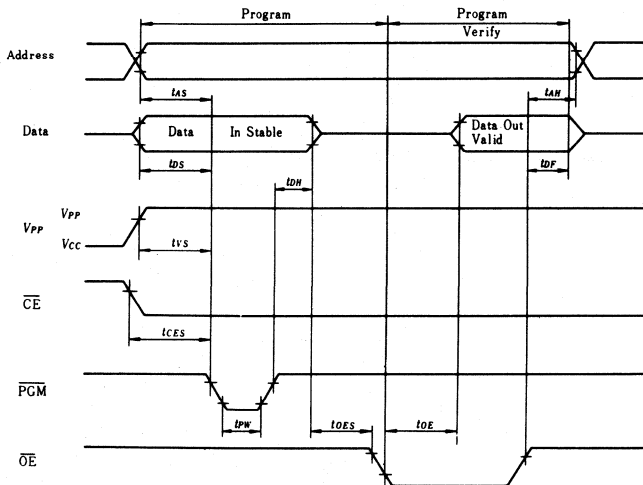

ERASE

Erase of HN4827128 is performed by exposure to ultraviolet light of 2537Å and all the output data are changed to "1" after this erasure procedure. The minimum integrated dose (i.e. UV intensity x exposure time) for erasure is 15 W·sec/cm².

■ HIGH PERFORMANCE PROGRAMMING

This device can be applied the High Performance Programming algorithm shown in following flow chart. This algorithm allows to obtain faster programming time without any voltage stress to the device nor deterioration in reliability of programmed data.

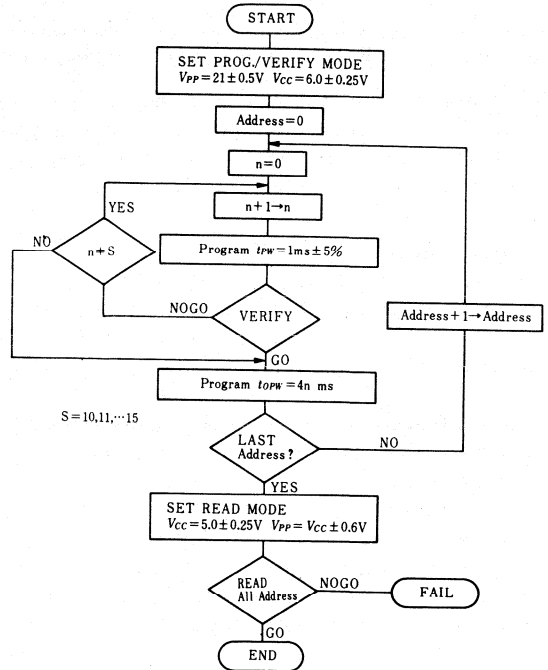

High Performance Programming Flowchart

● AC PROGRAMMING CHARACTERISTICS ($T_a = 25^\circ\text{C} \pm 5^\circ\text{C}$, $V_{CC} = 6\text{V} \pm 0.25\text{V}$, $V_{PP} = 21\text{V} \pm 0.5\text{V}$)

Parameter	Symbol	Test Condition	min	typ	max	Unit
Address Setup Time	t_{AS}		2	—	—	μs
OE Setup Time	t_{OES}		2	—	—	μs
Data Setup Time	t_{DS}		2	—	—	μs
Address Hold Time	t_{AH}		0	—	—	μs
Data Hold Time	t_{DH}		2	—	—	μs
OE to Output Float Delay*	t_{DF}		0	—	130	ns
V_{PP} Setup Time	t_{VPS}		2	—	—	μs
V_{CC} Setup Time	t_{VCS}		2	—	—	μs
PGM Pulse Width during Initial Program	t_{PW}		0.95	1.0	1.05	ms
PGM Pulse Width during Over Program**	t_{OPW}		3.8	—	63	ms
CE Setup Time	t_{CES}		2	—	—	μs
Data Valid from OE	t_{OE}		—	—	150	ns

* t_{DF} defines the time at which the output achieves the open circuit conditions and is not referenced to output voltage levels.

** t_{OPW} is defined as mentioned in flow chart.

● SWITCHING CHARACTERISTICS

Test Condition

Input Pulse Level: 0.8V to 2.2V
 Input Rise and Fall Time: ≤ 20 ns
 Reference Level for Measuring Timing: Input; 1V and 2V
 Output; 0.8V and 2V

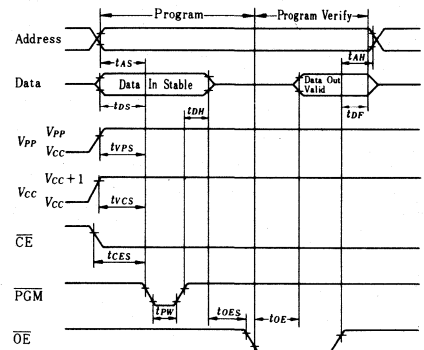

HN48016P

2048-word × 8-bit Electrically Erasable and Programmable ROM

This device operates from a single power supply and features fast single address location programming. All the words are erased by one TTL level pulse. Erasing the bit pattern and programming new pattern can be made within 42 seconds.

■ FEATURES

- Single Power Supply +5V ±5%
- Simple Programming Program voltage: +25V D.C.
Program with one 20ms pulse.
- Electrically Erasing Erase Voltage: +25V D.C.
Erase all words with one 200ms pulse.
- Fully Static No clocks required.
- Inputs and Outputs TTL compative during read, program and erase mode.
- Fully Decoded On-Chip Address Decode.
- Access Time 350ns Max.
- Low Power Dissipation 300mW Max.
- Three State Output OR-Tie Capability
- Pin-out Compatible with Intel 2716.

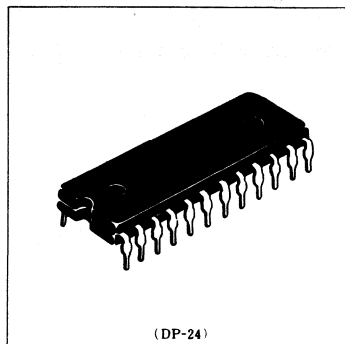

■ PIN. ARRANGEMENT

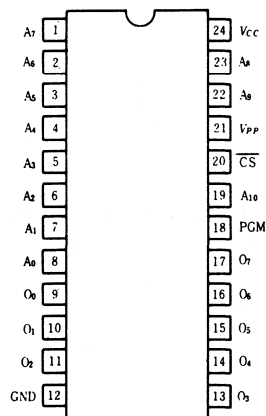

(Top View)

■ BLOCK DIAGRAM

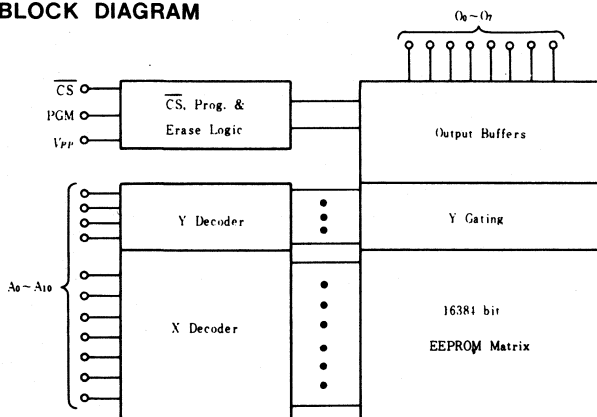

■ MODE SELECTION

Mode	Pins	PGM (18)	CS (20)	VPP (21)	VCC (24)	Outputs (8~11, 13~17)
Read		V_{IL}	V_{IL}	+5	+5	Dout
Deselect		Don't Care	V_{IH}	+5	+5	High Z
Program		Pulsed V_{IL} to V_{IH}	V_{IH}	+25	+5	Din
Program Verify		V_{IL}	V_{IL}	+25	+5	Dout
Program Inhibit		V_{IL}	V_{IH}	+25	+5	High Z
Erase		Pulsed V_{IL} to V_{IH}	V_{IL}	+25	+5	High Z

■ ABSOLUTE MAXIMUM RATINGS

Item	Symbol	Rating	Unit
All Input and Output Voltage	V_{IN}, V_{OUT}	-0.3 to $V_{CC} + 0.3$ or $V_{PP} + 0.3$	V
V_{CC} Voltage	V_{CC}	-0.3 to +7.0	V
V_{PP} Voltage	V_{PP}	-0.3 to +28	V
Operating Temperature Range	T_{OPR}	0 to +70	°C
Storage Temperature Range	T_{STG}	-55 to +125	°C

■ READ OPERATION

● DC AND OPERATING CHARACTERISTICS ($V_{CC} = 5V \pm 5\%$, $V_{PP} = V_{CC} \pm 0.6V$, * $T_a = 0$ to +70°C)

Parameter	Symbol	Test Condition	min	typ	max	Unit
Input Leakage Current	I_{LI}	$V_{IN} = 5.25V$	—	—	10	μA
Output Leakage Current	I_{LO}	$V_{OUT} = 5.25V$	—	—	10	μA
V_{CC} Current	I_{CC1}	$\overline{CS} = V_{IH}/V_{IL}$	—	32	50	mA
V_{PP} Current	I_{PP1}	$V_{PP} = 5.85V$	—	4	7	mA
Input Voltage	V_{IL}		-0.1	—	0.8	V
	V_{IH}		2.0	—	—	V
Output Voltage	V_{OL}	$I_{OL} = 1.6mA$	—	—	0.4	V
	V_{OH}	$I_{OH} = -100\mu A$	2.4	—	—	V

* The tolerance of 0.6V allows the use of a driver circuit for switching the V_{PP} supply pin from V_{CC} in read to 25V for programming.

● AC CHARACTERISTICS ($V_{CC} = 5V \pm 5\%$, $V_{PP} = V_{CC} \pm 0.6V$, $T_a = 0$ to +70°C)

Parameter	Symbol	Test Condition	min	typ	max	Unit
Address to Output Delay	t_{ACC}	$PGM = \overline{CS} = V_{IL}$	—	200	350	ns
Chip Select to Output Delay	t_{CO}	$PGM = V_{IL}$	—	70	150	ns
Chip Deselect to Output Float	t_{DF}		0	40	100	ns
Address to Output Hold	t_{OH}	$PGM = \overline{CS} = V_{IL}$	10	—	—	ns

● TEST CONDITION

Input pulse levels: 0.8V to 2.0V
 Input rise and fall time: $\leq 20ns$
 Output load: 1TTL Gate + 100 pF
 Reference level for Measuring Timing: Inputs 1V and 1.8V
 Outputs 0.8V and 2.0V

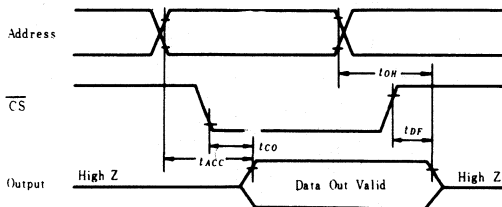

● CAPACITANCE ($T_a = 25^\circ C$, $f = 1MHz$)

Parameter	Symbol	Test Condition	typ	max	Unit
Input Capacitance	C_{in}	$V_{in} = 0V$	—	7.5	pF
Output Capacitance	C_{out}	$V_{out} = 0V$	—	15	pF

■ PROGRAM OPERATION

● DC PROGRAMMING CHARACTERISTICS ($V_{CC}=5V \pm 5\%$, $V_{PP}=25V \pm 1V$, $T_a=0$ to $+70^\circ C$)

Parameter	Symbol	Test Condition	min	typ	max	Unit
Input Leakage Current	I_{LI}	$V_{IN}=5.25V$	—	—	10	μA
V_{CC} Supply Current	I_{CC2}		—	32	50	mA
V_{PP} Supply Current	I_{PP2}		—	10	20	mA
Input Voltage	V_{IL}		-0.1	—	0.8	V
	V_{IH}		2.0	—	—	V

● AC PROGRAMMING CHARACTERISTICS ($V_{CC}=5V \pm 5\%$, $V_{PP}=25V \pm 1V$, $T_a=0$ to $+70^\circ C$)

Parameter	Symbol	Test Condition	min	typ	max	Unit
Address Setup Time	t_{AS}		2	—	—	μs
\overline{CS} Setup Time	t_{CSS}		2	—	—	μs
Data Setup Time	t_{DS}		2	—	—	μs
Address Hold Time	t_{AH}		2*	—	—	μs
\overline{CS} Hold Time	t_{CSH}		7	—	—	μs
Data Hold Time	t_{DH}		2	—	—	μs
Chip Deselect to Output Float Delay	t_{DF}		0	40	100	ns
Chip Select to Output Delay	t_{CO}		—	70	150	ns
Program Pulse Width	t_{PW}		15	20	25	ms
Program Pulse Rise Time	t_{PRT}		5	—	—	ns
Program Pulse Fall Time	t_{PFT}		5	—	—	ns
V_{PP} Setup Time	t_{PS}		10	—	—	μs
V_{PP} Hold Time	t_{PH}		10	—	—	μs
\overline{CS} to Program Mode Time	t_{VS}		10	—	—	μs
V_{PP} Read Mode Time	t_{VH}		10	—	—	μs

* If the mode changes from program mode to program verify mode sequentially (in the same address), t_{AH} must be larger than $t_{CSH} + t_{CO}$.

● TEST CONDITION

Test Condition

Input pulse levels: 0.8V to 2.0V
 Input rise and fall time: 20ns (10% to 90%)
 Reference level for Measuring Timing: Input; 1V and 1.8V
 Output: 0.8V and 2.0V

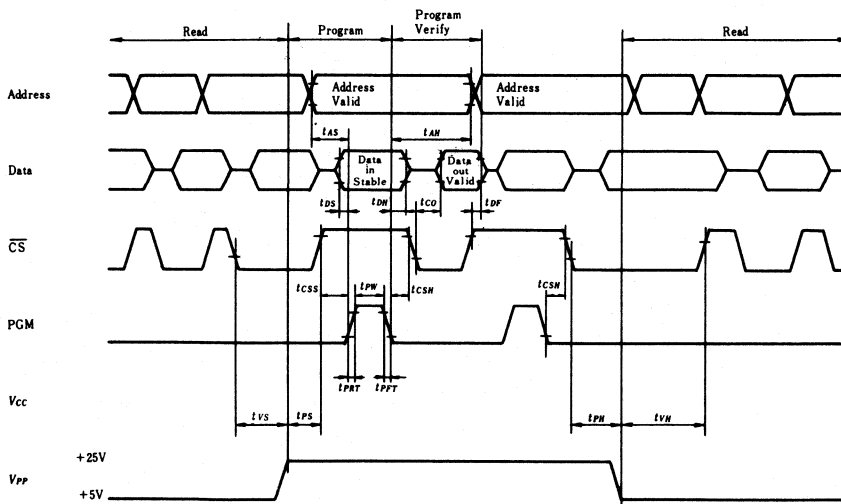

■ ERASE OPERATION

● DC ERASING CHARACTERISTICS ($V_{CC}=5V \pm 5\%$, $V_{PP}=25V \pm 1V$, $T_a=0$ to $+70^\circ\text{C}$)

Parameter	Symbol	Test Condition	min.	typ.	max.	Unit
Input Leakage Current	I_{LI}	$V_{IN}=5.25V$	—	—	10	μA
V_{CC} Supply Current	I_{CC3}		—	32	50	mA
V_{PP} Supply Current	I_{PP3}		—	10	20	mA
Input Voltage	V_{IL}		-0.1	—	0.8	V
	V_{IH}		2.0	—	—	V

● AC ERASING CHARACTERISTICS ($V_{CC}=5V \pm 5\%$, $V_{PP}=25V \pm 1V$, $T_a=0$ to $+70^\circ\text{C}$)

Parameter	Symbol	Test Condition	min.	typ.	max.	Unit
$\overline{\text{CS}}$ Setup Time	t_{ECSS}		2	—	—	μs
PGM to Output Delay	t_{EO}		7	—	—	μs
Erase Pulse Width	t_{EPW}		190	200	210	ms
Erase Pulse Rise Time	t_{ERT}		5	—	—	ns
Erase Pulse Fall Time	t_{EFT}		5	—	—	ns
V_{PP} Setup Time	t_{ES}		10	—	—	μs
V_{PP} Hold Time	t_{EH}		10	—	—	μs
Erase Program Time t_{EP}	t_{EP}		10	—	—	μs
Program Enase Time t_{PE}	t_{PE}		10	—	—	μs

● TEST CONDITION

Test Condition

Input pulse levels:	0.8V to 2.0V
Input rise and fall time:	20ns (10% to 90%)
Reference level for Measuring Timing:	Input: 1V and 1.8V Output: 0.8V and 2.0V

■ POWER SUPPLY SEQUENCE PRECAUTIONS

To protect the written data, power supply to the HN48016P should be turned on and off in the following order:

● Power On-Off Order and Input Level Limitation for $\overline{\text{CS}}$ and PGM Terminals

Table 1 shows the relationship between the order in which power supply for the HN48016P should be turned on and off and the input levels of the $\overline{\text{CS}}$ and PGM terminals.

- (1) For the 5V V_{PP} and V_{CC} , there is no limitation as to the order in which power is turned on and off the state of the input terminals $\overline{\text{CS}}$ and PGM.
- (2) When turning on and off power supply for the 25V V_{PP} , keep V_{CC} at between 4.5V and 7V, and PGM at "Low."
- (3) When turning on and off power supply for the 5V V_{CC} while V_{PP} equals $25V \pm 1V$ (this being a rare case for the HN48016P), make sure to keep PGM at "Low."

Fig. 1 shows the timing order in which power is turned on and off.

● Table 1. Power On-Off Order for HN48016P

Input Level		Power On-Off	
PGM	$\overline{\text{CS}}$	5V- V_{PP} - V_{CC}	25V- V_{PP}
V_{IL}	V_{IL}	Possible	Possible only when $V_{CC}=4.5\sim 7V^{*2}$
V_{IL}	V_{IH}		
V_{IH}	V_{IL}	Possible	impossible ^{*2}
V_{IH}	V_{IH}		

Note 1. If Power for the 25V V_{PP} were turned on or off while $V_{CC} = -0.3V$ to $+4.5V$, the data holding characteristic would probably deteriorate.

Note 2. If the 25V V_{PP} were operated to choose a "write" or "erase" mode while PGM = " V_{IH} ," contents of ROM would probably change.

● Example of Standard Power Supply Sequence

The following is an example of standard power supply sequence:

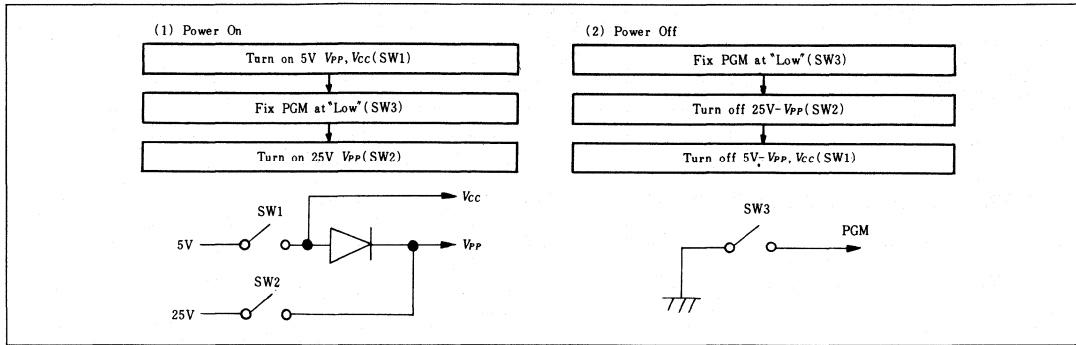

● Inter-mode Timing

The HN48016P has six operating modes, 5V Vpp read-out, non-selected, 25V Vpp write, write check, write inhibit, and erase. To protect the written data, keep the terminal PGM at "Low" for a period of 10μs before and after turning the terminal Vpp from 5V to 25V and vice versa.

The following describes the inter-mode timing for a system that uses the HN48016P.

● Readout → Write → Readout

Before turning the terminal Vpp to 25V, keep the terminal PGM at "Low" for a period of 10μs minimum (as indicated by tvs). After the terminal Vpp has been turned to 25V, keep the terminal CS at "Low" for a period of 10μs minimum (as indicated by tps). Before turning the terminal Vpp to 5V, keep the terminal CS at "Low" for a period of 10μs minimum (as indicated by tps). After the terminal Vpp has been turned to 5V, keep the terminal PGM at "Low" for a period of 10μs minimum (as indicated by tvh).

● Readout → Erase → Readout

This timing sequence is shown in Fig. 3. After turning the terminal Vpp to 25V, keep the terminal PGM at "Low" for a period of 10μs minimum (as indicated by tes). Keep the terminal PGM at "Low" for a period of 10μs minimum (as indicated by teH) before turning the terminal Vpp to 5V, as well.

● Erase → Write → Erase

This timing sequence is shown in Fig. 4. Before turning the terminal CS to "High (write mode)," keep the terminal PGM at "Low" for a period of 10μs minimum (as indicated by tep).

Before turning from "write" to "erase," keep the terminal CS at "Low" for a period of 10μs minimum (as indicated by tpe).

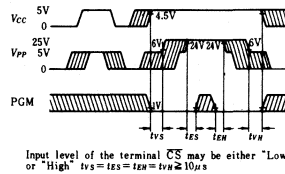

Fig. 1. Power on-off timing sequence.

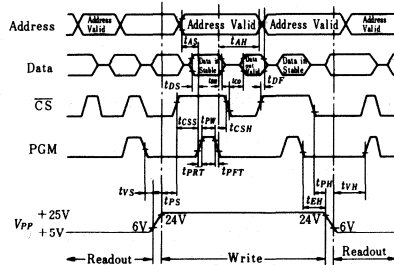

Fig. 2. "Readout → Write → Readout" timing

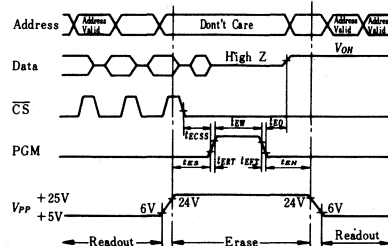

Fig. 3. "Readout → Erase → Readout" timing.

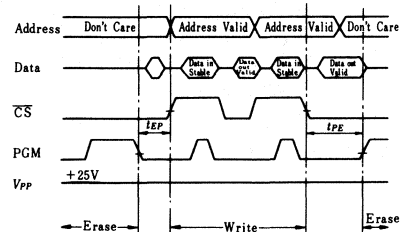

Fig. 4. "Erase → Write → Erase" timing.

BIPOLAR RAM

HM10414, HM10414-1

256-word × 1-bit Fully Decoded Random Access Memory

The HM10414 is ECL 10K compatible, 256-word × 1-bit, read write, random access memory developed for high speed systems such as scratch pad and control/buffer storages.

The fabrication process uses the Hitachi's low capacitance, oxide isolation method with double metalization.

The HM10414 is encapsulated in cerdip-16pin package, compatible with Fairchild's F10414.

- Fully compatible with 10K ECL level
- Address access time: HM10414: 10ns (max.)
HM10414-1: 8ns (max.)
- Write pulse width: 6ns (min.)
- Three chip select pins
- Output obtainable by wired-OR (open emitter)

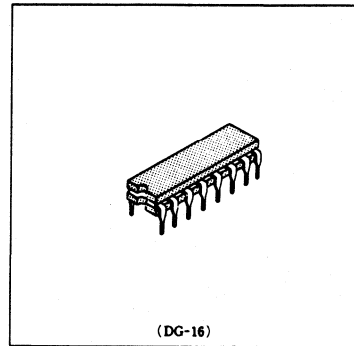

(DG-16)

PIN ARRANGEMENT

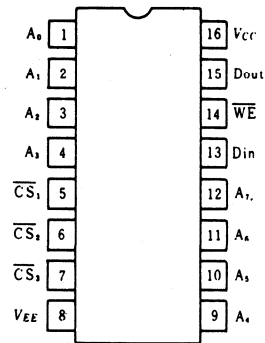

(Top View)

TRUTH TABLE

Input			Output	Mode
\overline{CS}	\overline{WE}	Din		
any one H	×	×	L	Not Selected
all L	L	L	L	Write "0"
all L	L	H	L	Write "1"
all L	H	×	Dout*	Read

× : Don't care

* : Read out non-inverted

BLOCK DIAGRAM

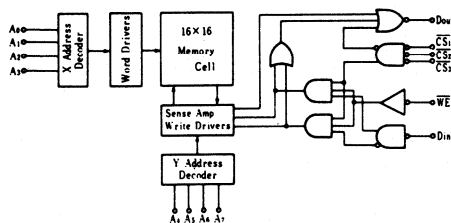

ABSOLUTE MAXIMUM RATINGS

Item	Symbol	Rating	Unit
Supply Voltage	V_{EE} to V_{CC}	+0.5 to -7.0	V
Input Voltage	V_{in}	+0.5 to V_{EE}	V
Output Current	I_{out}	-30	mA
Storage Temperature	T_{stg}	-65 to +150	°C
Storage Temperature	$T_{stg}(\text{Bias})^*$	-55 to +125	°C

* Under Bias

■ ELECTRICAL CHARACTERISTICS

● DC CHARACTERISTICS ($V_{EE} = -5.2V$, $R_L = 50\Omega$ to $-2.0V$, $T_a = 0$ to $+75^\circ C$, air flow exceeding 2m/sec)

Item	Symbol	Test Condition	min (B)	typ	max (A)	Unit		
Output Voltage	V_{OH}	$V_{IN} = V_{IHA}$ or V_{ILB}	0°C	-1000	-	-840	mV	
			+25°C	-960	-	-810		
			+75°C	-900	-	-720		
	V_{OL}		0°C	-1870	-	-1665		
			+25°C	-1850	-	-1650		
			+75°C	-1830	-	-1625		
Output Threshold Voltage	V_{OHC}	$V_{IN} = V_{IHB}$ or V_{ILC}	0°C	-1020	-	-	mV	
			+25°C	-980	-	-		
			+75°C	-920	-	-		
	V_{OLC}		0°C	-	-	-1645		
			+25°C	-	-	-1630		
			+75°C	-	-	-1605		
Input Voltage	V_{IH}	Guaranteed Input Voltage High for All Inputs	0°C	-1145	-	-840	mV	
			+25°C	-1105	-	-810		
			+75°C	-1045	-	-720		
	V_{IL}	Guaranteed Input Voltage Low for All Inputs	0°C	-1870	-	-1490		
			+25°C	-1850	-	-1475		
			+75°C	-1830	-	-1450		
Input Current	I_{IH}	$V_{IN} = V_{IHA}$	0 to +75°C	-	-	220	μA	
				I_{IL}	CS	0 to +75°C		0.5
	Other		-50					-
Supply Current	I_{EE}	All Input and Output Open, Test Pin 8	+75°C	-	-130	-	mA	
			0°C	-180	-140	-		

● AC CHARACTERISTICS

($V_{EE} = -5.2V \pm 5\%$, $T_a = 0$ to $+75^\circ C$, air flow exceeding 2m/sec, see test circuit and waveforms)

1. READ MODE

Item	Symbol	Test Condition	HM10414			HM10414-1			Unit
			min	typ	max	min	typ	max	
Chip Select Access Time	t_{ACR}		-	3	6	-	3	6	ns
Chip Select Recovery Time	t_{RCS}		-	3	6	-	3	6	ns
Address Access Time	t_{AA}		-	7	10	-	6	8	ns

2. WRITE MODE

Item	Symbol	Test Condition	min	typ	max	Unit
Write Pulse Width	t_W	$t_{WSA} = 2ns$	6	4	-	ns
Data Setup Time	t_{WSD}		1	0	-	ns
Data Hold Time	t_{WHD}		1	0	-	ns
Address Setup Time	t_{WSA}	$t_W = 6ns$	2	0	-	ns
Address Hold Time	t_{WHA}		2	0	-	ns
Chip Select Setup Time	t_{WSCS}		1	0	-	ns
Chip Select, Hold Time	t_{WHCS}		1	0	-	ns
Write Disable Time	t_{WS}		-	-	5	ns
Write Recovery Time	t_{WR}		-	-	5	ns

3. RISE/FALL TIME

Item	Symbol	Test Condition	min	typ	max	Unit
Output Rise Time	t_r		-	1.5	2.5	ns
Output Fall Time	t_f		-	1.5	2.5	ns

4. CAPACITANCE

Item	Symbol	Test Condition	min	typ	max	Unit
Input Capacitance	C_{in}		-	3	5	pF
Output Capacitance	C_{out}		-	5	8	pF

■ TEST CIRCUIT AND WAVEFORMS

1. LOADING CONDITIONS

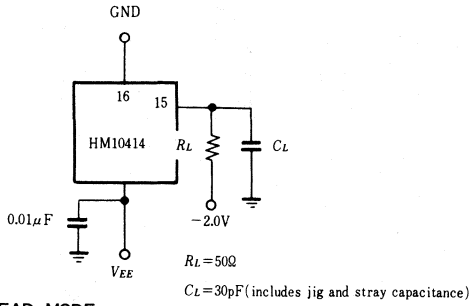

2. INPUT PULSE

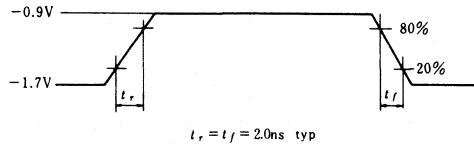

3. READ MODE

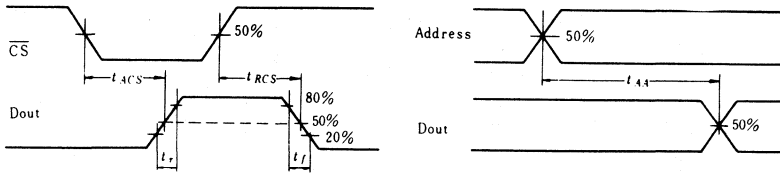

4. WRITE MODE

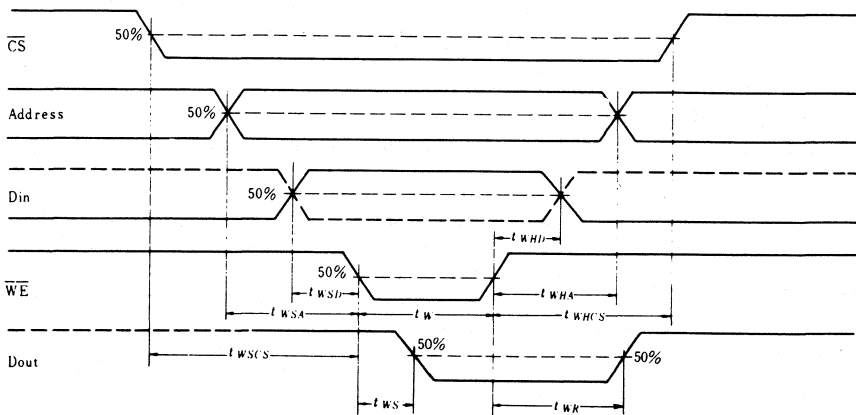

SUPPLY CURRENT vs. AMBIENT TEMPERATURE

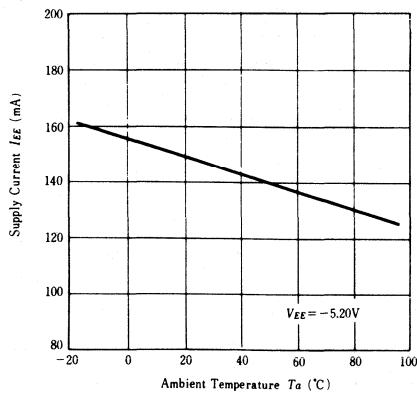

SUPPLY CURRENT vs. SUPPLY VOLTAGE

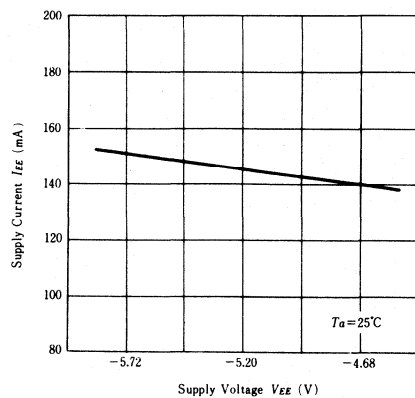

**ADDRESS ACCESS TIME
vs. AMBIENT TEMPERATURE**

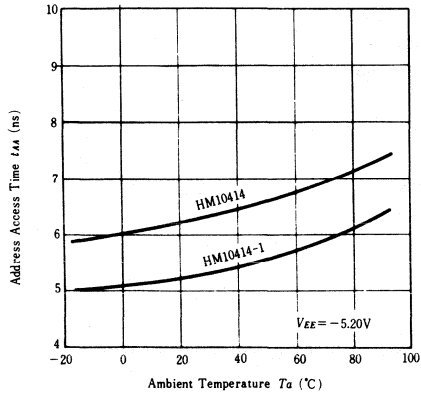

**ADDRESS ACCESS TIME
vs. SUPPLY VOLTAGE**

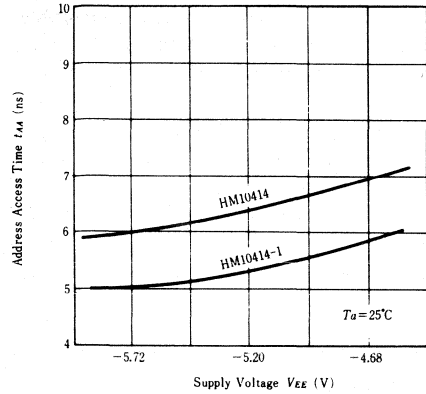

**CHIP SELECT ACCESS TIME
vs. AMBIENT TEMPERATURE**

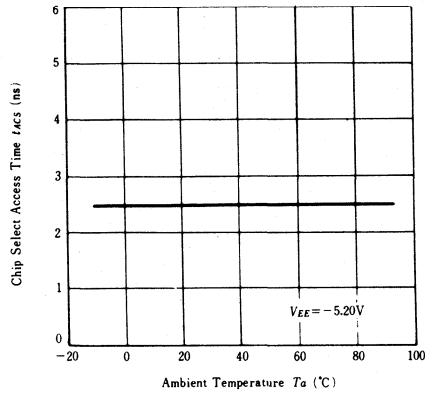

**CHIP SELECT ACCESS TIME
vs. SUPPLY VOLTAGE**

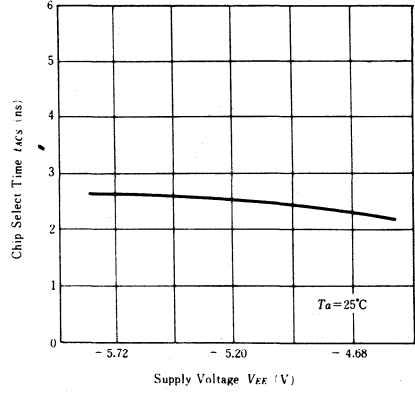

**WRITE PULSE WIDTH
vs. AMBIENT TEMPERATURE**

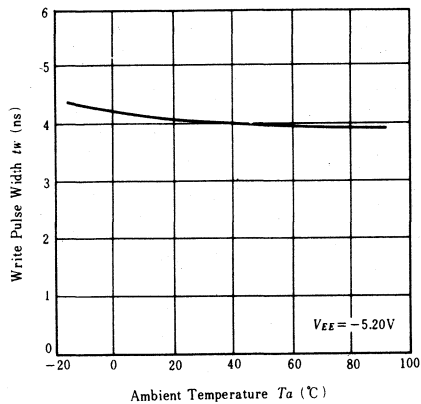

**WRITE PULSE WIDTH
vs. SUPPLY VOLTAGE**

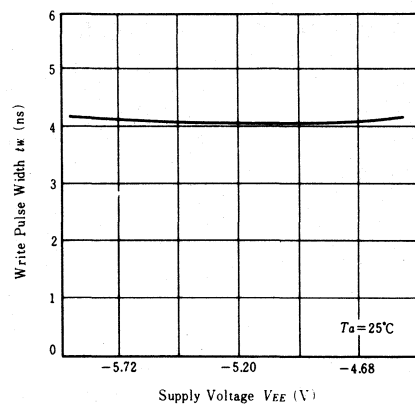

HM2110, HM2110-1

1024-word × 1-bit Fully Decoded Random Access Memory

The HM2110 Series item is an ECL compatible, 1024-word x 1-bit, read/write, random access memory developed for application to scratch pads, control and buffer memories, etc. which require high speeds.

- It is compatible with 10K ECL logic.
- Chip select access time 10ns (max.)
- Address access time HM2110: 35ns (max.)
HM2110-1: 25ns (max.)
- Power consumption , 0.5mW/bit (typ)
- Output obtainable by Wired-OR (open emitter).

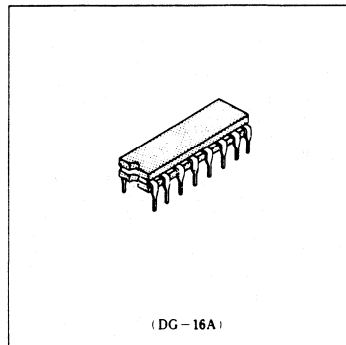

(DG-16A)

TRUTH TABLE

Input			Output	Mode
\overline{CS}	\overline{WE}	Din		
H	×	×	L	Not Selected
L	L	L	L	Write "0"
L	L	H	L	Write "1"
L	H	×	Dout*	Read

× : irrelevant

* : Read out noninverted

BLOCK DIAGRAM

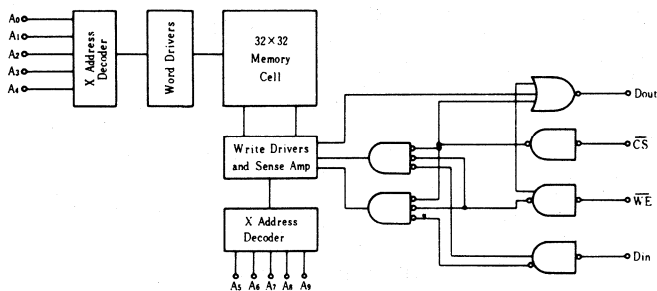

PIN ARRANGEMENT

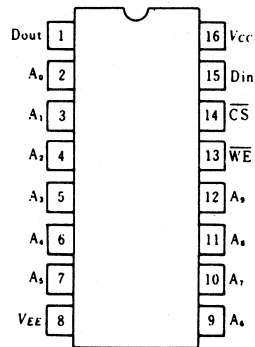

(Top View)

ABSOLUTE MAXIMUM RATINGS

Item	Symbol	HM2110 Series	Unit
Supply Voltage	V_{EE} to V_{CC}	+0.5 to -7.0	V
Input Voltage	V_{in}	+0.5 to V_{EE}	V
Output Current	I_{out}	-30	mA
Storage Temperature	T_{stg}	-65 to +150	°C
Storage Temperature	$T_{stg}(Bias)^*$	-55 to +125	°C

* Under Bias

■ ELECTRICAL CHARACTERISTICS

● DC CHARACTERISTICS ($V_{EE} = -5.2V$, $R_L = 50\Omega$ to $-2.0V$, $T_a = 0$ to $+75^\circ C$, air flow exceeding 2m/sec)

Item	Symbol	Test Condition	min(B)	typ	max(A)	Unit		
Output Voltage	V_{OH}	$V_{IN} = V_{IHA}$ or V_{ILB}	0°C	-1000	—	-840	mV	
			+25°C	-960	—	-810		
			+75°C	-900	—	-720		
	V_{OL}		0°C	-1870	—	-1665		
			+25°C	-1850	—	-1650		
			+75°C	-1830	—	-1625		
Output Threshold Voltage	V_{OHC}	$V_{IN} = V_{IHB}$ or V_{ILA}	0°C	-1020	—	—	mV	
			+25°C	-980	—	—		
			+75°C	-920	—	—		
	V_{OLC}		0°C	—	—	-1645		
			+25°C	—	—	-1630		
			+75°C	—	—	-1605		
Input Voltage	V_{IH}	Guaranteed Input Voltage High for All Inputs	0°C	-1145	—	-840	mV	
			+25°C	-1105	—	-810		
			+75°C	-1045	—	-720		
	V_{IL}		0°C	-1870	—	-1490		
			+25°C	-1850	—	-1475		
			+75°C	-1830	—	-1450		
Input Current	I_{IH}	$V_{IN} = V_{IHA}$	0 to +75°C	—	—	220	μA	
			I_{IL}	CS	0 to +75°C	0.5		—
	Other			—		—		—
Supply Current	I_{EE}	All Input and Output Open, Test Pin 8	$0 \leq T_a < 25^\circ C$	-150	-100	—	mA	
			$T_a \geq 25^\circ C$	-125	-90	—		

● AC CHARACTERISTICS

($V_{EE} = -5.2V \pm 5\%$, $T_a = 0$ to $+75^\circ C$, air flow exceeding 2m/sec, see test circuit and waveforms)

1. READ MODE

Item	Symbol	Test Condition	HM2110			HM2110-1			Unit
			min	typ	max	min	typ	max	
Chip Select Access Time	t_{ACS}		—	7	10	—	7	10	ns
Chip Select Recovery Time	t_{RCS}		—	7	10	—	7	10	ns
Address Access Time	t_{AA}		—	20	35	—	15	25	ns

2. WRITE MODE

Item	Symbol	Test Condition	HM2110			HM2110-1			Unit
			min	typ	max	min	typ	max	
Write Pulse Width	t_W	$t_{WSA} = 8ns$	25	—	—	25	—	—	ns
Data Setup Time	t_{WSD}	$t_W = 25ns$	5	—	—	5	—	—	ns
Data Hold Time	t_{WHD}		5	—	—	5	—	—	ns
Address Setup Time	t_{WSA}		8	—	—	8	—	—	ns
Address Hold Time	t_{WHA}		2	—	—	2	—	—	ns
Chip Select Setup Time	t_{WSCS}		5	—	—	5	—	—	ns
Chip Select Hold Time	t_{WHCS}		5	—	—	5	—	—	ns
Write Disable Time	t_{WSD}		—	—	10	—	—	10	ns
Write Recovery Time	t_{WR}		—	—	10	—	—	10	ns

3. RISE/FALL TIME

Item	Symbol	Test Condition	min	typ	max	Unit
Output Rise Time	t_r		—	5	—	ns
Output Fall Time	t_f		—	5	—	ns

4. CAPACITANCE

Item	Symbol	Test Condition	min	typ	max	Unit
Input Capacitance	C_{in}		—	4	5	pF
Output Capacitance	C_{out}		—	7	8	pF

■ TEST CIRCUIT AND WAVEFORMS

1. LOADING CONDITION

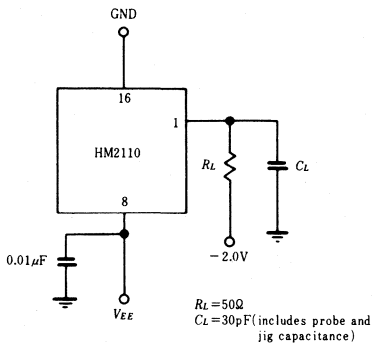

2. INPUT PULSE

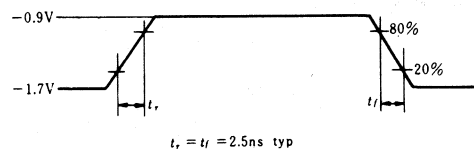

3. READ MODE

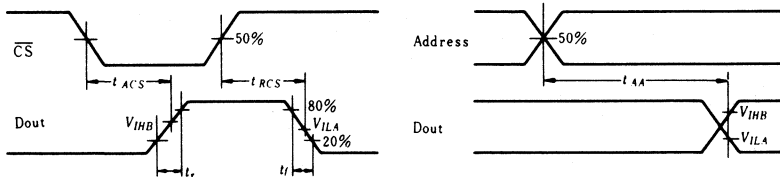

4. WRITE MODE

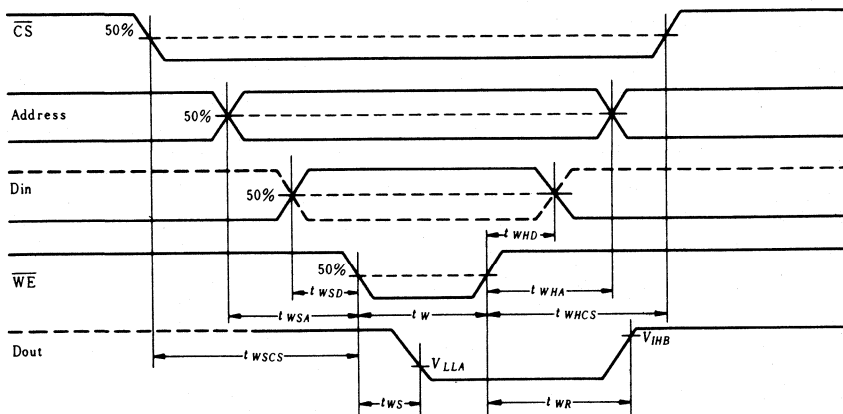

**SUPPLY CURRENT vs.
AMBIENT TEMPERATURE**

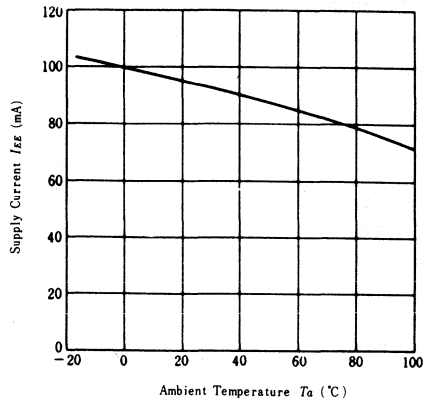

**SUPPLY CURRENT vs.
SUPPLY VOLTAGE**

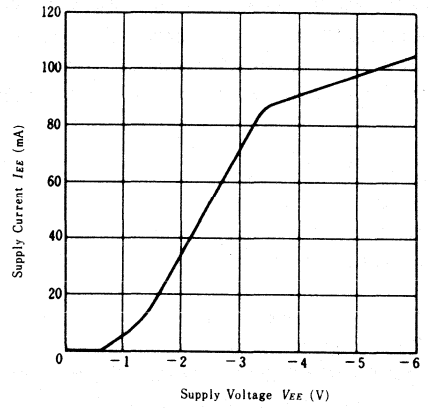

**ADDRESS ACCESS TIME vs.
AMBIENT TEMPERATURE**

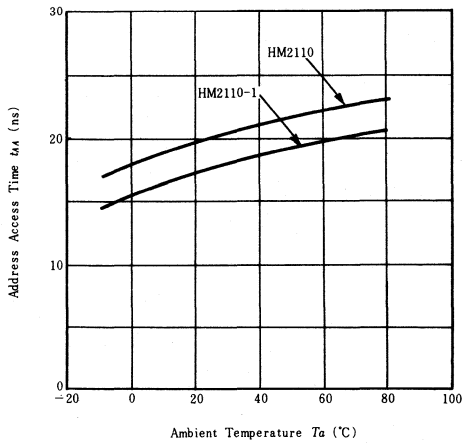

HM2112, HM2112-1

1024-word × 1-bit Fully Decoded Random Access Memory

The HM2112 is an ECL compatible, 1024-word × 1-bit, read/write, random access memory developed for application to scratch pads, control and buffer memories, etc. which require high speeds.

■ FEATURES

- Level 10k ECL Compatible
- Construction 1024-word by 1-bit
- Address Access Time HM2112 10ns (max.)
HM2112-1 8ns (max.)
- Chip Select Access Time 5ns (max.)
- Power Consumption 0.8mW/bit (typ)
- Output Obtainable by Wired-OR (open emitter)
- Fully Pin Compatible with F10415

■ TRUTH TABLE

Input			Output	Mode
CS	WE	Din		
H	×	×	L	Not Selected
L	L	L	L	Write "0"
L	L	H	L	Write "1"
L	H	×	Dout*	Read

× : Irrelevant

* : Read out noninverted

■ BLOCK DIAGRAM

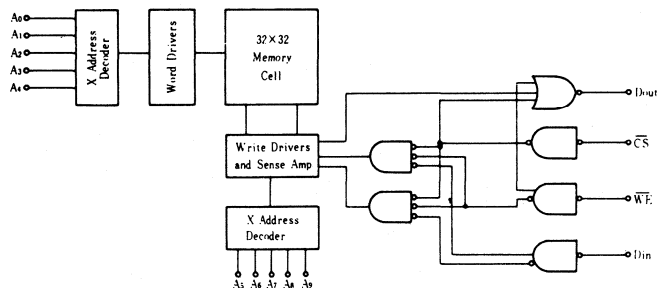

■ ABSOLUTE MAXIMUM RATINGS

Item	Symbol	HM2112	Unit
Supply Voltage	V_{EE} to V_{CC}	+0.5 to -7.0	V
Input Voltage	V_{in}	+0.5 to V_{EE}	V
Output Current	I_{out}	-30	mA
Storage Temperature	T_{stg}	-65 to +150	°C
Storage Temperature	$T_{stg}(\text{Bias})^*$	-55 to +125	°C

* Under Bias

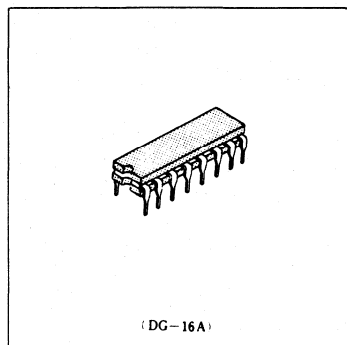

■ PIN ARRANGEMENT

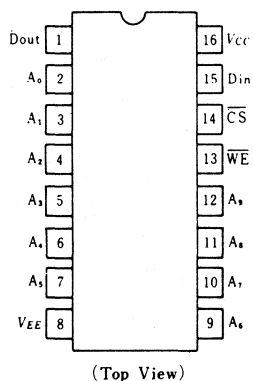

(Top View)

ELECTRICAL CHARACTERISTICS

($V_{EE} = -5.2V$, $R_L = 50\Omega$ to $-2.0V$, $T_a = 0$ to $+75^\circ C$, air flow exceeding 2m/sec)

DC CHARACTERISTICS

Item	Symbol	Test Condition	min(B)	typ	max(A)	Unit	
Output Voltage	V_{OH}	$V_{IN} = V_{IHA}$ or V_{ILB}	0°C	-1000	—	-840	mV
			+25°C	-960	—	-810	
			+75°C	-900	—	-720	
	V_{OL}		0°C	-1870	—	-1665	
			+25°C	-1850	—	-1650	
			+75°C	-1830	—	-1625	
Output Threshold Voltage	V_{OHC}	$V_{IN} = V_{IHB}$ or V_{ILA}	0°C	-1020	—	—	mV
			+25°C	-980	—	—	
			+75°C	-920	—	—	
	V_{OLC}		0°C	—	—	-1645	
			+25°C	—	—	-1630	
			+75°C	—	—	-1605	
Input Voltage	V_{IH}	Guaranteed Input Voltage High for All Inputs	0°C	-1145	—	-840	mV
			+25°C	-1105	—	-810	
			+75°C	-1045	—	-720	
	V_{IL}		0°C	-1870	—	-1490	
			+25°C	-1850	—	-1475	
			+75°C	-1830	—	-1450	
Input Current	I_{IL}	$V_{IN} = V_{IHA}$	0 to +75°C	—	—	220	μA
				CS	$V_{IN} = V_{ILB}$	0.5	
	Other	—	—			—	
Supply Current	I_{EE}	All Input and Output Open, Test Pin 8	$T_a = 0^\circ C$	-200	—	—	mA
			$T_a = 75^\circ C$	-170	—	—	

AC CHARACTERISTICS

($V_{EE} = -5.2V \pm 5\%$, $T_a = 0$ to $+75^\circ C$, air flow exceeding 2m/sec, see test circuit and waveforms)

1. READ MODE

Item	Symbol	Test Condition	HM2112-1			HM2112			Unit
			min	typ	max	min	typ	max	
Chip Select Access Time	t_{ACS}		1	3	5	1	3	5	ns
Chip Select Recovery Time	t_{RCS}		1	3	5	1	3	5	ns
Address Access Time	t_{AA}		3	6.5	8	3	7.5	10	ns

2. WRITE MODE

Item	Symbol	Test Condition	HM2112-1			HM2112			Unit
			min	typ	max	min	typ	max	
Write Pulse Width	t_w	$t_{WSA} = 3ns$	6	2	—	6	2	—	ns
Data Setup Time	t_{WSD}		1	0	—	1	0	—	ns
Data Hold Time	t_{WHD}		1	0	—	1	0	—	ns
Address Setup Time	t_{WSA}	$t_w = 6ns$	3	0	—	3	0	—	ns
Address Hold Time	t_{WHA}		2	0	—	2	0	—	ns
Chip Select Setup Time	t_{WSCS}		1	0	—	1	0	—	ns
Chip Select Hold Time	t_{WHCS}		1	0	—	1	0	—	ns
Write Disable Time	t_{WS}		1	3	5	1	3	5	ns
Write Recovery Time	t_{WR}		1	3	5	1	3	5	ns

3. RISE/FALL TIME

Item	Symbol	Test Condition	min	typ	max	Unit
Output Rise Time	t_r		0.8	1.5	2.5	ns
Output Fall Time	t_f		0.8	1.5	2.5	ns

4. CAPACITANCE

Item	Symbol	Test Condition	min	typ	max	Unit
Input Capacitance	C_{in}		1	3	5	pF
Output Capacitance	C_{out}		3	5	8	pF

■ TEST CIRCUIT AND WAVEFORMS

1. LOADING CONDITION

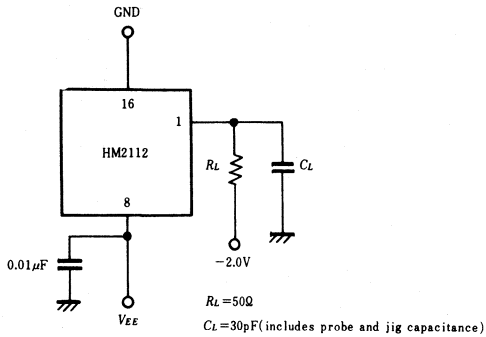

2. INPUT PULSE

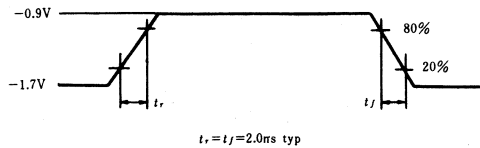

3. READ MODE

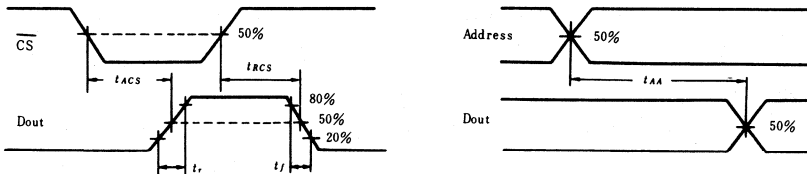

4. WRITE MODE

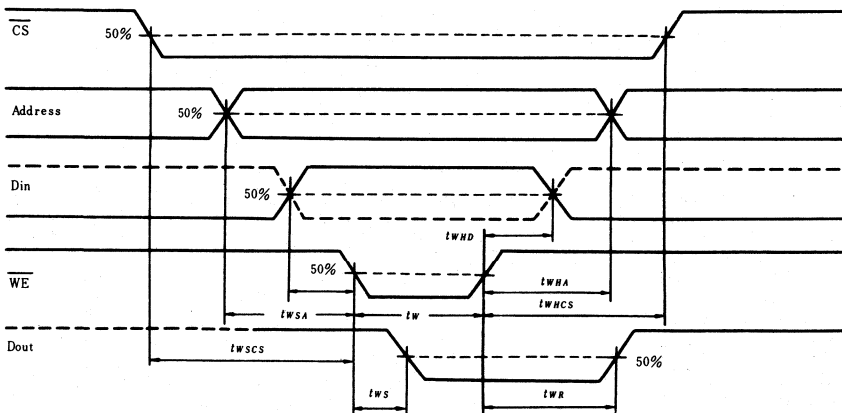

SUPPLY CURRENT vs. AMBIENT TEMPERATURE

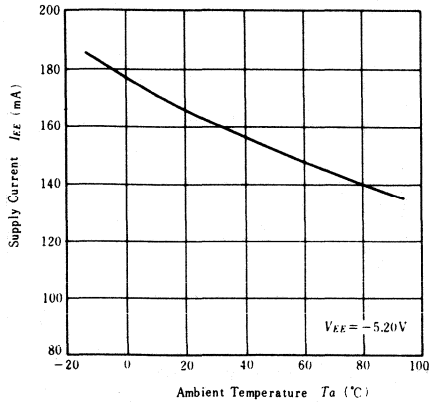

SUPPLY CURRENT vs. SUPPLY VOLTAGE

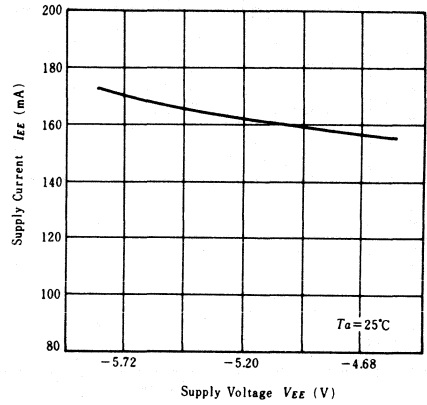

ADDRESS ACCESS TIME vs. AMBIENT TEMPERATURE

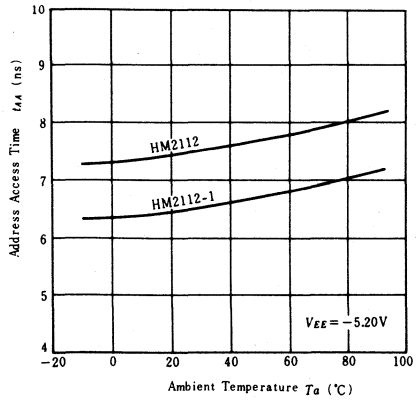

ADDRESS ACCESS TIME vs. SUPPLY VOLTAGE

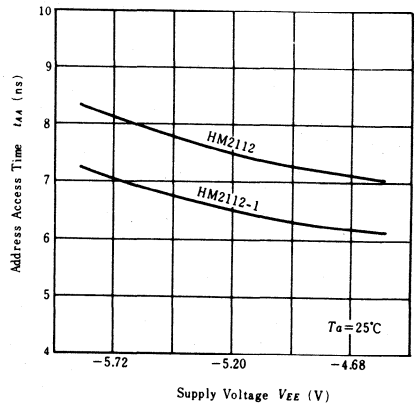

CHIP SELECT ACCESS TIME vs. AMBIENT TEMPERATURE

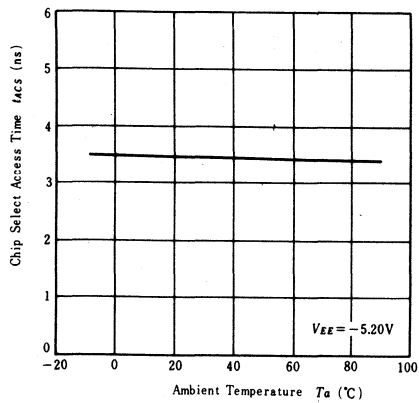

CHIP SELECT ACCESS TIME vs. SUPPLY VOLTAGE

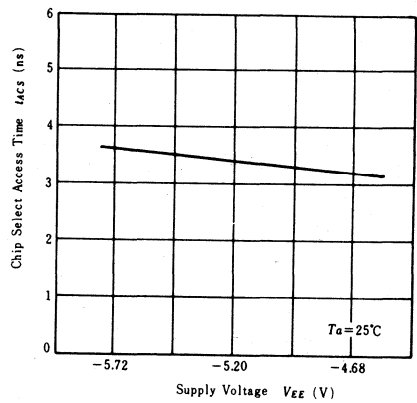

**WRITE PULSE WIDTH
vs. AMBIENT TEMPERATURE**

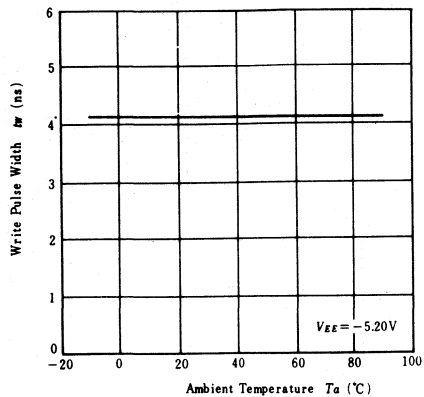

**WRITE PULSE WIDTH
vs. SUPPLY VOLTAGE**

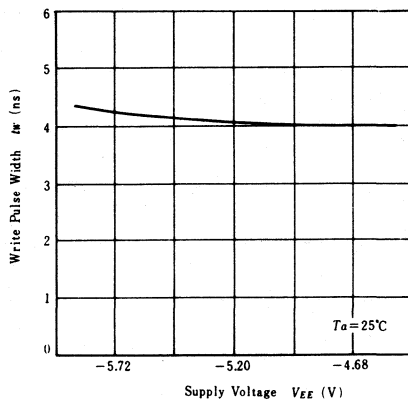

HM10422

256-word × 4-bit Fully Decoded Random Access Memory

The HM10422 is ECL 10K compatible, 256-word × 4-bit, read write, random access memory developed for high speed systems such as scratch pads and control buffer storages.

Four active Low Block Select lines are provided to select each block independently.

The fabrication process is the Hitachi's low capacitance, oxide isolation method with double metalization.

The HM10422 is encapsulated in cerdip-24 pin package, compatible with Fairchild's F10422.

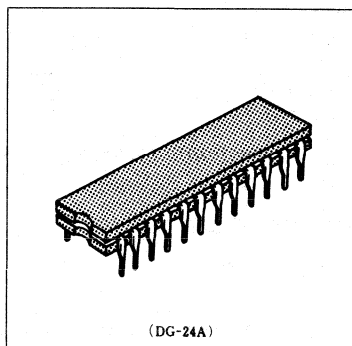

(DG-24A)

FEATURES

- 256-word × 4 bit organization.
- Fully compatible with 10K ECL level
- Address access time: 10ns (max)
- Write pulse width: 6ns (min)
- Power dissipation: 0.8mW/bit
- Output obtainable by wired-OR (open emitter)

TRUTH TABLE

Input			Output	Mode
BS	WE	Din		
H	×	×	L	Not Selected
L	L	L	L	Write "0"
L	L	H	L	Write "1"
L	H	×	Dout*	Read

Notes) × : Irrelevant
* : Read out noninvert

BLOCK DIAGRAM

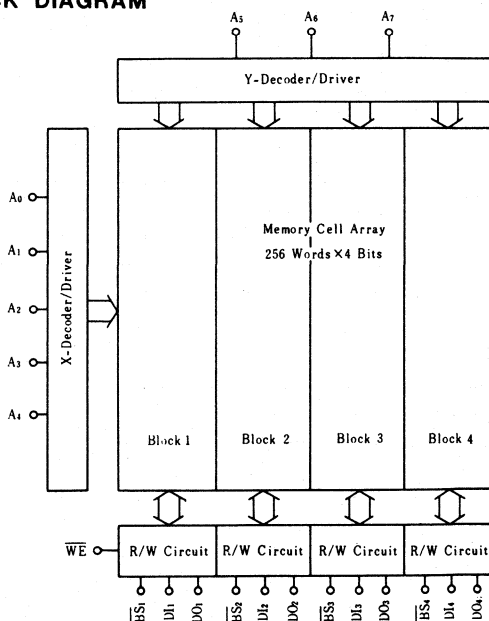

PIN ARRANGEMENT

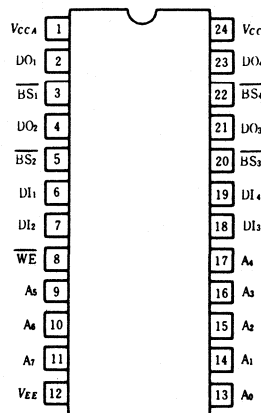

(Top View)

■ ABSOLUTE MAXIMUM RATINGS

Item	Symbol	Rating	Unit
Supply Voltage	V_{EE} to V_{CC}	+0.5 to -7.0	V
Input Voltage	V_{in}	+0.5 to V_{EE}	V
Output Current	I_{out}	-30	mA
Storage Temperature	T_{stg}	-65 to +150	°C
Storage Temperature	$T_{stg}(\text{Bias})^*$	-55 to +125	°C

* Under Bias

■ ELECTRICAL CHARACTERISTICS

($V_{EE} = -5.2\text{V}$, $R_L = 50\Omega$ to -2.0V , $T_a = 0$ to $+75^\circ\text{C}$, air flow exceeding 2m/sec)

● DC CHARACTERISTICS

Item	Symbol	Test Condition	min(B)	typ	max(A)	Unit	
Output Voltage	V_{OH}	$V_{IN} = V_{IHA}$ or V_{ILB}	0°C	-1000	—	-840	mV
			+25°C	-960	—	-810	
			+75°C	-900	—	-720	
	V_{OL}		0°C	-1870	—	-1665	
			+25°C	-1850	—	-1650	
			+75°C	-1830	—	-1625	
Output Threshold Voltage	V_{OHC}	$V_{IN} = V_{IHB}$ or V_{ILA}	0°C	-1020	—	—	mV
			+25°C	-980	—	—	
			+75°C	-920	—	—	
	V_{OLC}		0°C	—	—	-1645	
			+25°C	—	—	-1630	
			+75°C	—	—	-1605	
Input Voltage	V_{IH}	Guaranteed Input Voltage High for All Inputs	0°C	-1145	—	-840	mV
			+25°C	-1105	—	-810	
			+75°C	-1045	—	-720	
	V_{IL}		0°C	-1870	—	-1490	
			+25°C	-1850	—	-1475	
			+75°C	-1830	—	-1450	
Input Current	I_{IH}	$V_{IN} = V_{IHA}$	0 to +75°C	—	—	220	μA
	I_{IL}	$\overline{\text{BS}}$	$V_{IN} = V_{ILB}$	0 to +75°C	0.5	—	
Other		—			—	—	
Supply Current	I_{EE}	All Input and Output Open, Test Pin 12	$T_a = 0^\circ\text{C}$	-200	-160	—	mA
			$T_a = 75^\circ\text{C}$	—	-145	—	

● AC CHARACTERISTICS

1. READ MODE

Item	Symbol	Test Condition	min	typ	max	Unit
Block Select Access Time	t_{ABS}		—	—	5	ns
Block Select Recovery Time	t_{RBS}		—	—	5	ns
Address Access Time	t_{AA}		—	7	10	ns

2. WRITE MODE

Item	Symbol	Test Condition	min	typ	max	Unit
Write Pulse Width	t_W	$t_{WSA} = 2\text{ns}$	6	4.5	—	ns
Data Setup Time	t_{WSD}		2	0	—	ns
Data Hold Time	t_{WHD}		2	0	—	ns
Address Setup Time	t_{WSA}		$t_W = 6\text{ns}$	2	0	—
Address Hold Time	t_{WHA}		2	0	—	ns
Block Select Setup Time	t_{WSBS}		2	0	—	ns
Block Select Hold Time	t_{WHBS}		2	0	—	ns
Write Disable Time	t_{WS}		—	4	5	ns
Write Recovery Time	t_{WR}		—	4.5	9	ns

3. RISE/FALL TIME

Item	Symbol	Test Condition	min	typ	max	Unit
Output Rise Time	t_r		—	2	—	ns
Output Fall Time	t_f		—	2	—	ns

4. CAPACITANCE

Item	Symbol	Test Condition	min	typ	max	Unit
Input Capacitance	C_{in}		—	4	—	pF
Output Capacitance	C_{out}		—	7	—	pF

■ TEST CIRCUIT AND WAVEFORMS

1. LOADING CONDITION

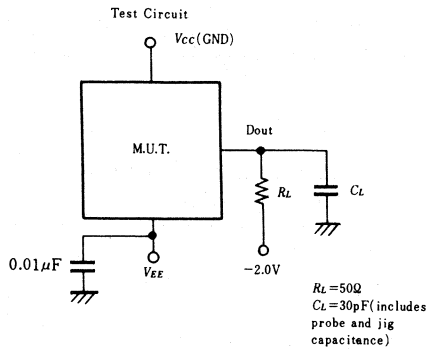

2. INPUT PULSE

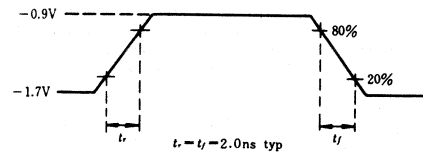

3. READ MODE

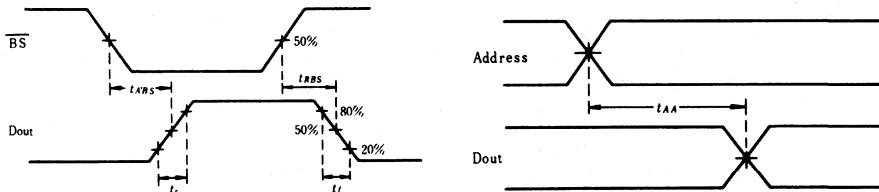

4. WRITE MODE

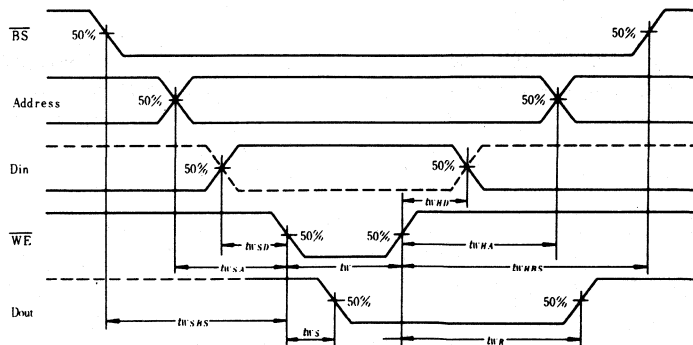

SUPPLY CURRENT vs. AMBIENT TEMPERATURE

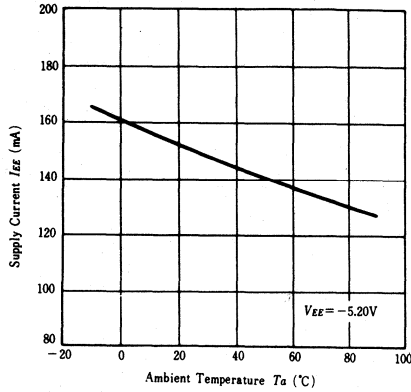

SUPPLY CURRENT vs. SUPPLY VOLTAGE

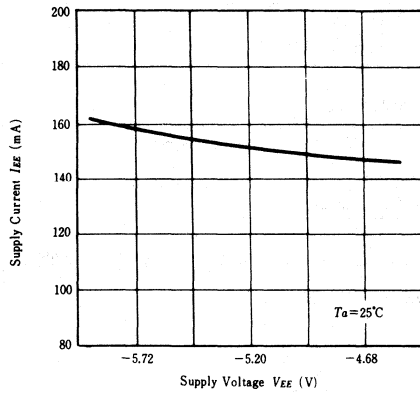

ADDRESS ACCESS TIME vs. AMBIENT TEMPERATURE

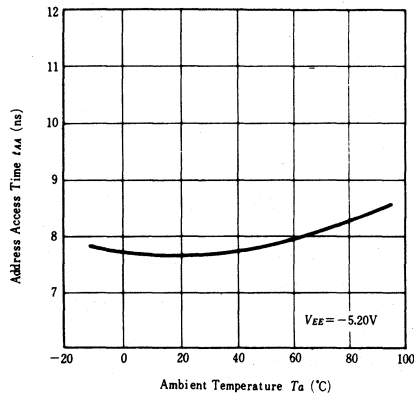

ADDRESS ACCESS TIME vs. SUPPLY VOLTAGE

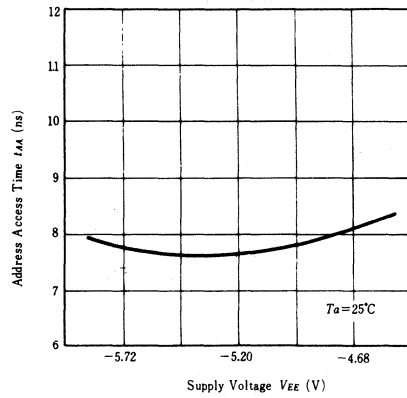

BLOCK SELECT ACCESS TIME vs. AMBIENT TEMPERATURE

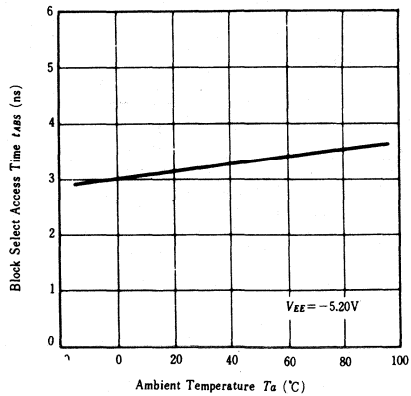

BLOCK SELECT ACCESS TIME vs. SUPPLY VOLTAGE

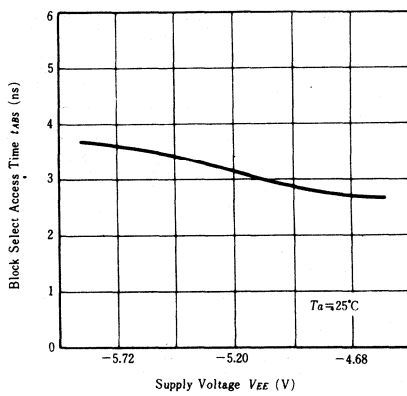

**WRITE PULSE WIDTH vs.
AMBIENT TEMPERATURE**

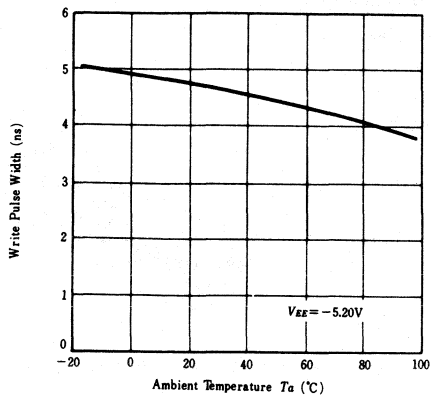

**WRITE PULSE WIDTH vs.
SUPPLY VOLTAGE**

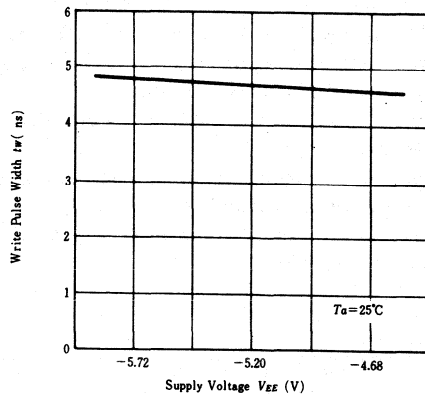

HM10422-7

256-word × 4-bit Fully Decoded Random Access Memory

The HM10422 is ECL 10K compatible, 256-word x 4-bit, read write, random access memory developed for high speed systems such as scratch pads and control buffer storages.

Four active Low Block Select lines are provided to select each block independently.

The fabrication process is the Hitachi's low capacitance, oxide isolation method with double metalization.

The HM10422 is encapsulated in cerdip-24 pin package, compatible with Fairchild's F10422.

■ FEATURES

- 256-word x 4 bit organization
- Fully compatible with 10K ECL level
- Address access time: 7ns (max)
- Write pulse width: 4ns (min)
- Power dissipation: 1.0 mW/bit
- Output obtainable by wired-OR (open emitter)

■ TRUTH TABLE

Input			Output	Mode
BS	WE	Din		
H	×	×	L	Not Selected
L	L	L	L	Write "0"
L	L	H	L	Write "1"
L	H	×	Dout*	Read

Notes) × : Irrelevant

* : Read out noninvert

■ BLOCK DIAGRAM

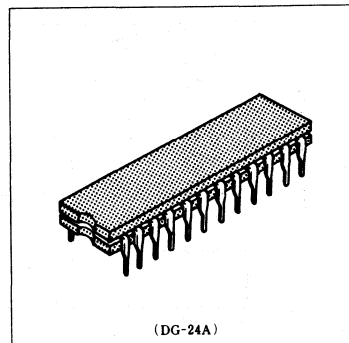
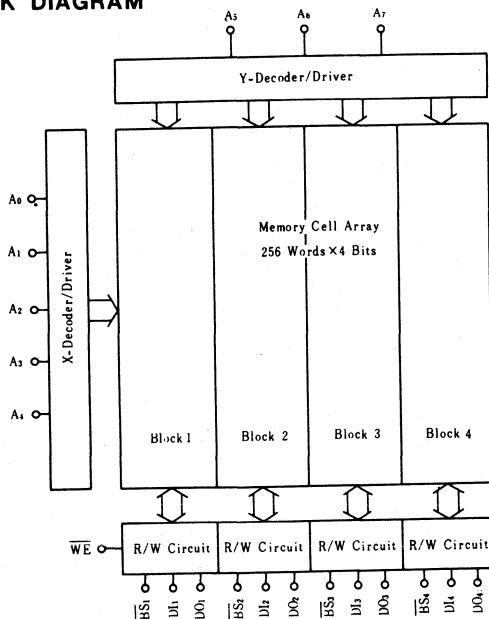

(DG-24A)

■ PIN ARRANGEMENT

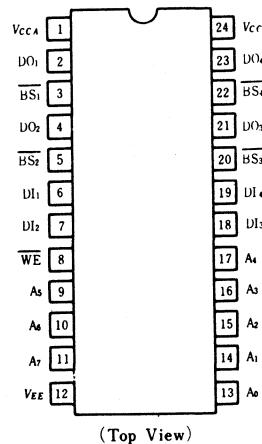

■ ABSOLUTE MAXIMUM RATINGS

Item	Symbol	Rating	Unit
Supply Voltage	V_{EE} to V_{CC}	+0.5 to -7.0	V
Input Voltage	V_{in}	+0.5 to V_{EE}	V
Output Current	I_{out}	-30	mA
Storage Temperature	T_{stg}	-65 to +150	°C
Storage Temperature	$T_{stg}(\text{Bias})^*$	-55 to +125	°C

* Under Bias

■ ELECTRICAL CHARACTERISTICS

($V_{EE} = -5.2\text{V}$, $R_L = 50\Omega$ to -2.0V , $T_a = 0$ to $+75^\circ\text{C}$, air flow exceeding 2m/sec)

● DC CHARACTERISTICS

Item	Symbol	Test Condition	min(B)	typ	max(A)	Unit		
Output Voltage	V_{OH}	$V_{IN} = V_{IHA}$ or V_{ILB}	0°C	-1000	—	-840	mV	
			+25°C	-960	—	-810		
			+75°C	-900	—	-720		
	V_{OL}		0°C	-1870	—	-1665		
			+25°C	-1850	—	-1650		
			+75°C	-1830	—	-1625		
Output Threshold Voltage	V_{OHC}	$V_{IN} = V_{IHB}$ or V_{ILA}	0°C	-1020	—	—	mV	
			+25°C	-980	—	—		
			+75°C	-920	—	—		
	V_{OLC}		0°C	—	—	-1645		
			+25°C	—	—	-1630		
			+75°C	—	—	-1605		
Input Voltage	V_{IH}	Guaranteed Input Voltage High for All Inputs	0°C	-1145	—	-840	mV	
			+25°C	-1105	—	-810		
			+75°C	-1045	—	-720		
	V_{IL}		0°C	-1870	—	-1490		
			+25°C	-1850	—	-1475		
			+75°C	-1830	—	-1450		
Input Current	I_{IH}	$V_{IN} = V_{IHA}$	0 to +75°C	—	—	220	μA	
	I_{IL}	BS	$V_{IN} = V_{ILB}$	0 to +75°C	0.5	—		170
		Other		—	—	—		
Supply Current	I_{EE}	All Input and Output Open, Test Pin 12	$T_a = 0^\circ\text{C}$	-240	-200	—	mA	
			$T_a = 75^\circ\text{C}$	—	-180	—		

● AC CHARACTERISTICS

1. READ MODE

Item	Symbol	Test Condition	min	typ	max	Unit
Block Select Access Time	t_{ABS}		—	—	5	ns
Block Select Recovery Time	t_{RBS}		—	—	5	ns
Address Access Time	t_{AA}		—	4	7	ns

2. WRITE MODE

Item	Symbol	Test Condition	min	typ	max	Unit
Write Pulse Width	t_W	$t_{WSA} = 2\text{ns}$	4	3	—	ns
Data Setup Time	t_{WSD}		1	—	—	ns
Data Hold Time	t_{WHD}		1	—	—	ns
Address Setup Time	t_{WSA}		$t_W = 4\text{ns}$	2	—	—
Address Hold Time	t_{WHA}		1	—	—	ns
Block Select Setup Time	t_{WSBS}		1	—	—	ns
Block Select Hold Time	t_{WHBS}		1	—	—	ns
Write Disable Time	t_{WS}		—	3	5	ns
Write Recovery Time	t_{WR}		—	3	5	ns

3. RISE/FALL TIME

Item	Symbol	Test Condition	min	typ	max	Unit
Output Rise Time	t_r		—	2	—	ns
Output Fall Time	t_f		—	2	—	ns

4. CAPACITANCE

Item	Symbol	Test Condition	min	typ	max	Unit
Input Capacitance	C_{in}		—	3	—	pF
Output Capacitance	C_{out}		—	5	—	pF

■ TEST CIRCUIT AND WAVEFORMS

1. LOADING CONDITION

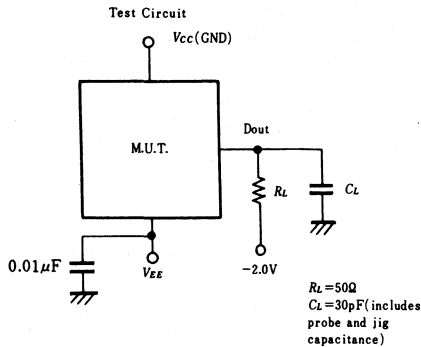

2. INPUT PULSE

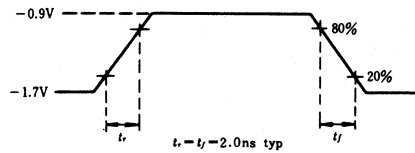

3. READ MODE

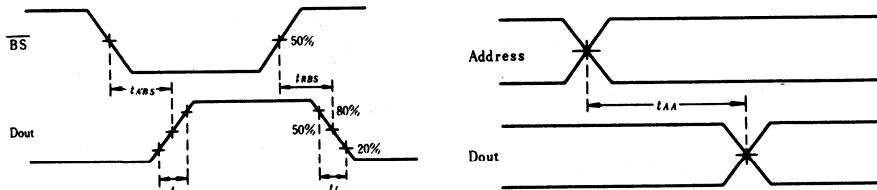

4. WRITE MODE

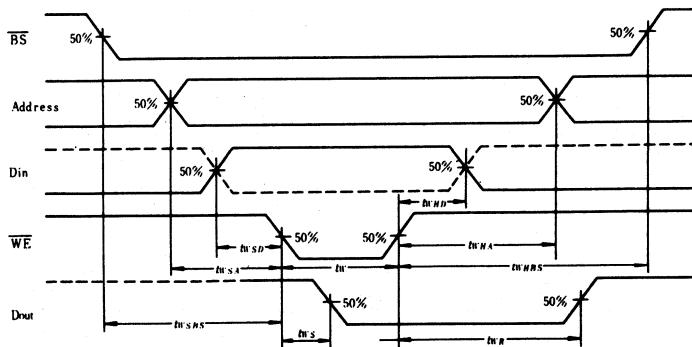

HM10470, HM10470-1, HM10470F

4096-word x 1-bit Fully Decoded Random Access Memory

The HM10470/F is ECL 10K compatible, 4096-words x 1-bit, read write random access memory developed for high speed systems such as scratch pads and control/buffer storages.

The fabrication process is the Hitachi's low capacitance, oxide isolation method with double metalization.

The HM10470/F is encapsulated in cerdip-18 pin and Flat-18 pin package, compatible with Fairchild's F10470.

■ FEATURES

- 4096-word x 1-bit organization
- Fully compatible with 10K ECL level
- Address access time: HM10740/F 25ns (max)
HM10470-1 15ns (max)
- Write pulse width: HM10470/F 25ns (min)
HM10470-1 15ns (min)
- Low power dissipation: 0.2mW/bit
- Output obtainable by wired-OR (open emitter)

■ TRUTH TABLE

Input			Output	Mode
\overline{CS}	\overline{WE}	Din		
H	X	X	L	Not Selected
L	L	L	L	Write "0"
L	L	H	L	Write "1"
L	H	X	Dout*	Read

Notes) X : Irrelevant
* : Read Out Noninvert

■ BLOCK DIAGRAM

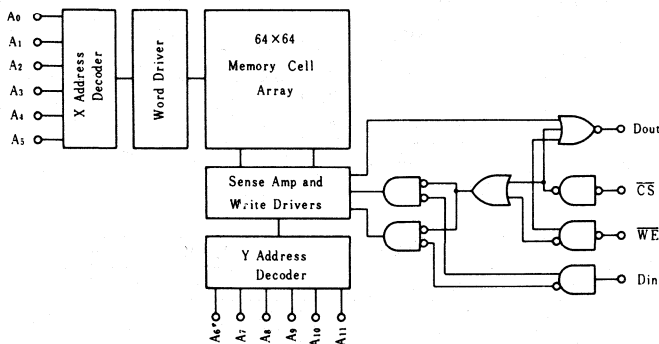

■ ABSOLUTE MAXIMUM RATINGS ($T_a = 25^\circ\text{C}$)

Item	Symbol	Rating	Unit
Supply Voltage	V_{EE} to V_{CC}	+0.5 to -7.0	V
Input Voltage	V_{in}	+0.5 to V_{EE}	V
Output Current	I_{out}	-30	mA
Storage Temperature	T_{stg}	-65 to +150	$^\circ\text{C}$
Storage Temperature	$T_{stg}(\text{Bias})^*$	-55 to +125	$^\circ\text{C}$

* Under Bias

HM10470, HM10470-1

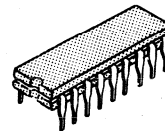

(DG-18)

HM10470F

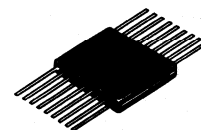

(FG-18)

■ PIN ARRANGEMENT

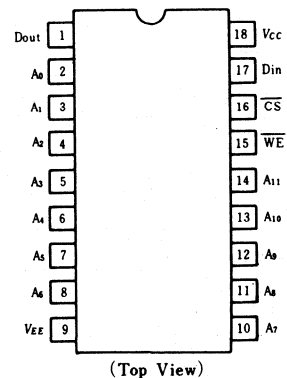

■ TEST CIRCUIT AND WAVEFORMS

● DC CHARACTERISTICS ($V_{EE} = -5.2V$, $R_L = 50\Omega$ to $-2.0V$, $T_a = 0$ to $+75^\circ C$, air flow exceeding 2m/sec)

Item	Symbol	Test Condition		min (B)	typ	max (A)	Unit			
Output Voltage	V_{OH}	$V_{IN} = V_{IHA}$ or V_{ILB}		0°C	-1000	-	-840			
				+25°C	-960	-	-810			
				+75°C	-900	-	-720			
	V_{OL}			0°C	-1870	-	-1665			
				+25°C	-1850	-	-1650			
				+75°C	-1830	-	-1625			
Output Threshold Voltage	V_{OHC}	$V_{IN} = V_{IHB}$ or V_{ILA}		0°C	-1020	-	-			
				+25°C	-980	-	-			
				+75°C	-920	-	-			
	V_{OLC}			0°C	-	-	-1645			
				+25°C	-	-	-1630			
				+75°C	-	-	-1605			
Input Voltage	V_{IH}	Guaranteed Input Voltage High for All Inputs		0°C	-1145	-	-840			
				+25°C	-1105	-	-810			
				+75°C	-1045	-	-720			
	V_{IL}			Guaranteed Input Voltage Low for All Inputs		0°C	-1870	-	-1490	
						+25°C	-1850	-	-1475	
						+75°C	-1830	-	-1450	
Input Current	I_{IH}	$V_{IN} = V_{IHA}$				0 to +75°C		-	-	220
								0 to +75°C		0.5
	I_{IL}					$V_{IN} = V_{ILB}$				0 to +75°C
				0 to +75°C				-	-	
Supply Current	I_{EE}	All Input and Output Open, Test Pin 9						$T_a = 0^\circ C$		-200*
				$T_a = 75^\circ C$						-280**
						0 to +75°C		-	-145	-
				0 to +75°C				-	-	-

* HM10470/F

** HM10470-1

● AC CHARACTERISTICS ($V_{EE} = -5.2V \pm 5\%$, $T_a = 0$ to $+75^\circ C$, air flow exceeding 2m/sec)

Item	Symbol	Test Condition	HM10470/F			HM10470-1			Unit
			min	typ	max	min	typ	max	
Chip Select Access Time	t_{ACS}		-	-	10	-	-	8	ns
Chip Select Recovery Time	t_{RCS}		-	-	10	-	-	8	ns
Address Access Time	t_{AA}		-	15	25	-	12	15	ns

2. WRITE MODE

Item	Symbol	Test Condition	HM10470/F			HM10470-1			Unit
			min	typ	max	min	typ	max	
Write Pulse Width	t_w	$t_{WSA} = 3ns$	25	-	-	15	-	-	ns
Data Setup Time	t_{WSD}		2	-	-	2	-	-	ns
Data Hold Time	t_{WHD}		2	-	-	2	-	-	ns
Address Setup Time	t_{WSA}		$t_w = t_{wmin}$	3	-	-	3	-	-
Address Hold Time	t_{WHA}		2	-	-	2	-	-	ns
Chip Select Setup Time	t_{WSDS}		2	-	-	2	-	-	ns
Chip Select Hold Time	t_{WHCS}		2	-	-	2	-	-	ns
Write Disable Time	t_{WS}		-	-	10	-	-	8	ns
Write Recovery Time	t_{WR}		-	-	10	-	-	8	ns

3. RISE/FALL TIME

Item	Symbol	Test Condition	min	typ	max	Unit
Output Rise Time	t_r		—	2	—	ns
Output Fall Time	t_f		—	2	—	ns

4. CAPACITANCE

Item	Symbol	Test Condition	min	typ	max	Unit
Input Capacitance	C_{in}		—	3	—	pF
Output Capacitance	C_{out}		—	5	—	pF

■ TEST CIRCUIT AND WAVEFORMS

1. LOADING CONDITION

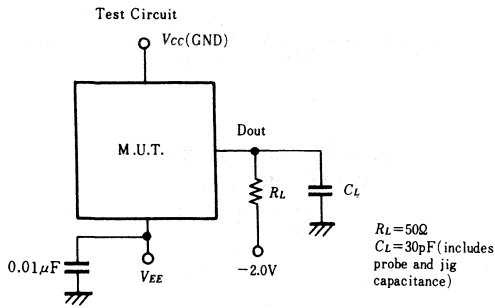

2. INPUT PULSE

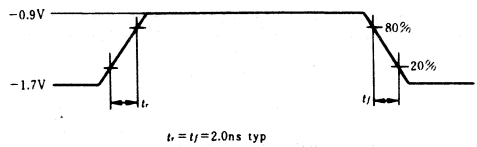

3. READ MODE

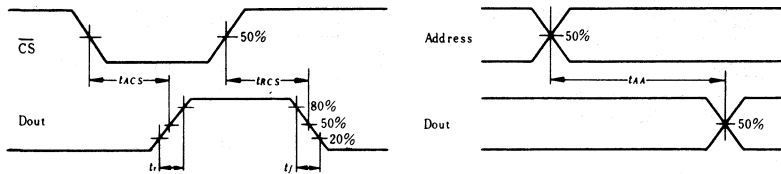

4. WRITE MODE

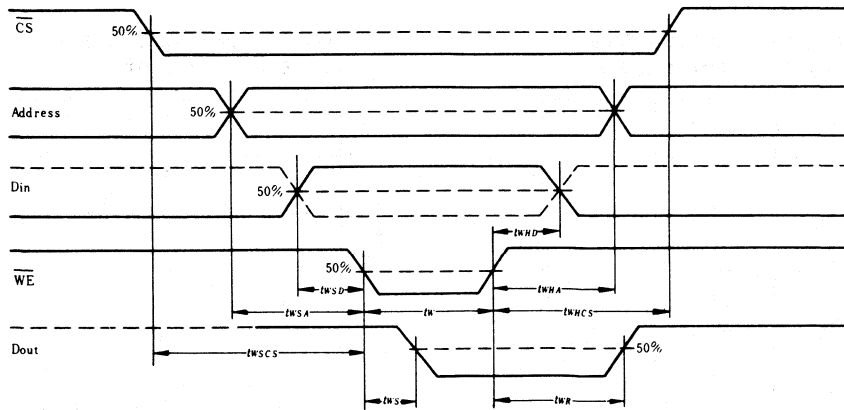

SUPPLY CURRENT vs. AMBIENT TEMPERATURE

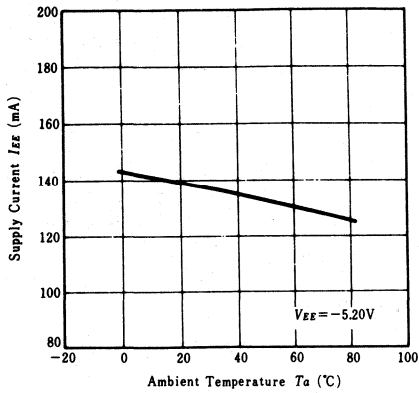

SUPPLY CURRENT vs. SUPPLY VOLTAGE

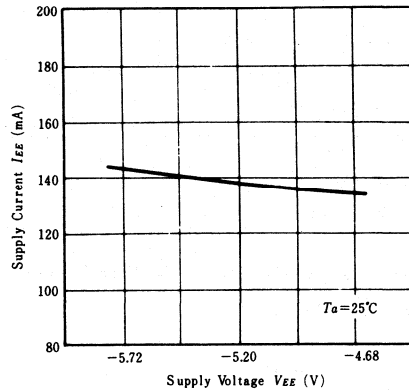

ADDRESS ACCESS TIME vs. AMBIENT TEMPERATURE

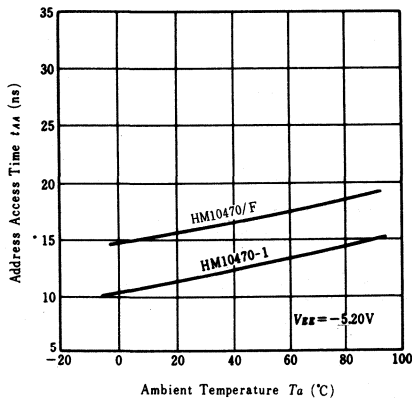

ADDRESS ACCESS TIME vs. SUPPLY VOLTAGE

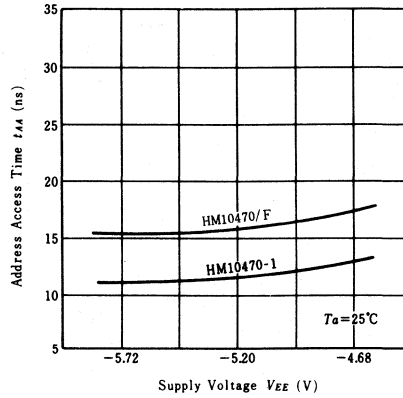

CHIP SELECT ACCESS TIME vs. AMBIENT TEMPERATURE

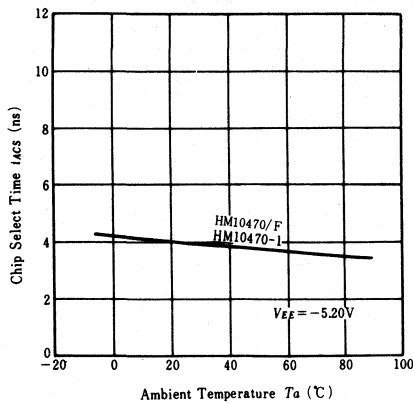

CHIP SELECT ACCESS TIME vs. SUPPLY VOLTAGE

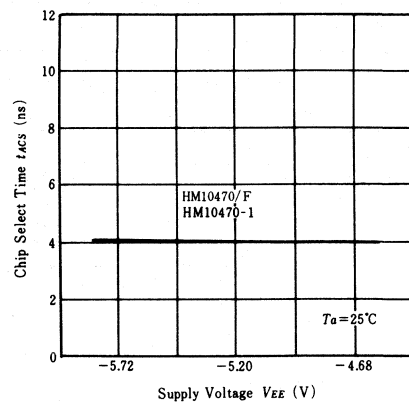

**WRITE PULSE WIDTH vs.
AMBIENT TEMPERATURE**

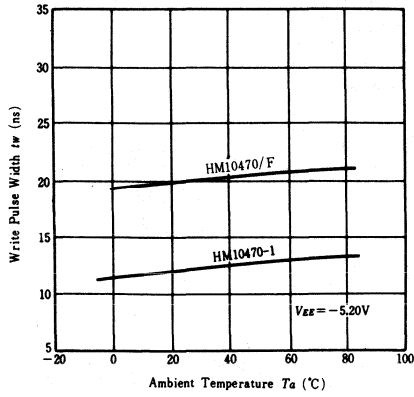

**WRITE PULSE WIDTH vs.
SUPPLY VOLTAGE**

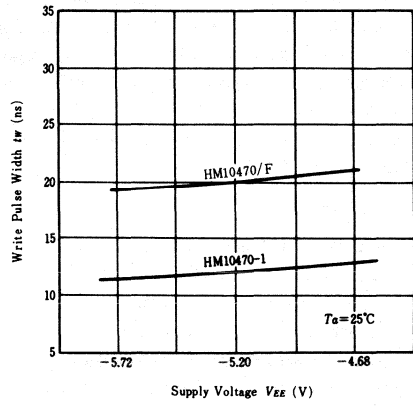

HM10470-15

4096-word × 1-bit Fully Decoded Random Access Memory

The HM10470 is ECL 10K compatible, 4096-words x 1-bit, read/write, random access memory developed for high speed systems such as scratch pads and control/buffer storages.

The fabrication process uses the Hitachi's low capacitance, oxide isolation method with double metalization.

The HM10470 is encapsulated in cerdip-18 pin package, compatible with Fairchild's F10470.

FEATURES

- 4096-word x 1-bit organization
- Fully compatible with 10K ECL level
- Address access time: 15ns (max)
- Write pulse width: 15ns (min)
- Low power dissipation: 0.2 mW/bit
- Output obtainable by wired-OR (open emitter)

TRUTH TABLE

Input			Output	Mode
\overline{CS}	WE	Din		
H	×	×	L	Not Selected
L	L	L	L	Write "0"
L	L	H	L	Write "1"
L	H	×	Dout *	Read

Notes) × : Irrelevant

* : Read Out Noninvert

BLOCK DIAGRAM

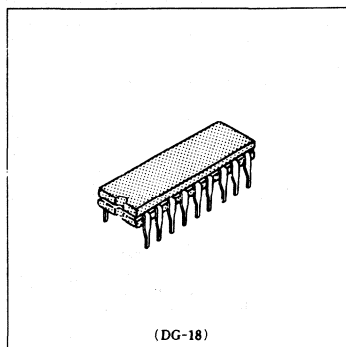
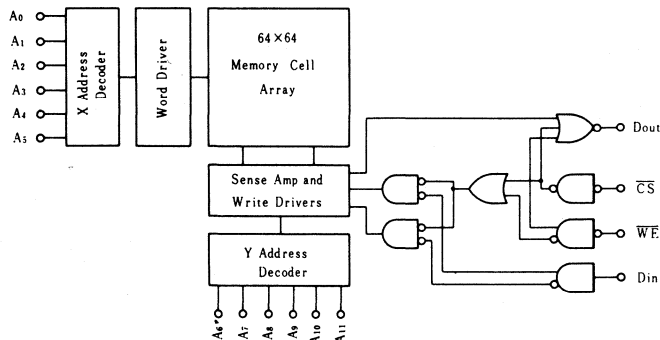

PIN ARRANGEMENT

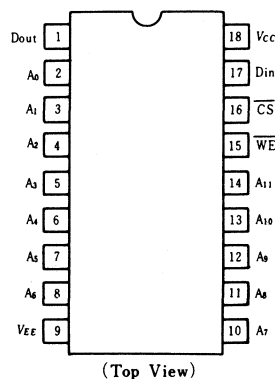

ABSOLUTE MAXIMUM RATINGS ($T_a = 25^\circ\text{C}$)

Item	Symbol	Rating	Unit
Supply Voltage	V_{EE} to V_{CC}	+0.5 to -7.0	V
Input Voltage	V_{in}	+0.5 to V_{EE}	V
Output Current	I_{out}	-30	mA
Storage Temperature	T_{stg}	-65 to +150	$^\circ\text{C}$
Storage Temperature	$T_{stg}(\text{Bias})^*$	-55 to +125	$^\circ\text{C}$

* Under Bias

■ ELECTRICAL CHARACTERISTICS

● DC CHARACTERISTICS ($V_{EE} = -5.2V$, $R_L = 50\Omega$ to $-2.0V$, $T_a = 0$ to $+75^\circ C$, air flow exceeding 2m/sec)

Item	Symbol	Test Condition		min (B)	typ	max (A)	Unit			
Output Voltage	V_{OH}	$V_{IN} = V_{IHA}$ or V_{ILB}		0°C	-1000	-	-840	mV		
				+25°C	-960	-	-810			
				+75°C	-900	-	-720			
	V_{OL}			0°C	-1870	-	-1665			
				+25°C	-1850	-	-1650			
				+75°C	-1830	-	-1625			
Output Threshold Voltage	V_{OHC}	$V_{IN} = V_{IHB}$ or V_{ILA}		0°C	-1020	-	-	mV		
				+25°C	-980	-	-			
				+75°C	-920	-	-			
	V_{OLC}			0°C	-	-	-1645			
				+25°C	-	-	-1630			
				+75°C	-	-	-1605			
Input Voltage	V_{IH}	Guaranteed Input Voltage High for All Inputs		0°C	-1145	-	-840	mV		
				+25°C	-1105	-	-810			
				+75°C	-1045	-	-720			
	V_{IL}			0°C	-1870	-	-1490			
				+25°C	-1850	-	-1475			
				+75°C	-1830	-	-1450			
Input Current	I_{IH}	$V_{IN} = V_{IHA}$		0 to +75°C	-	-	220	μA		
				I_{IL}	$V_{IN} = V_{ILB}$		0 to +75°C		0.5	-
	Other						-50		-	-
Supply Current	I_{EE}	All Input and Output Open, Test Pin 12		$T_a = 0^\circ C$	-200	-160	-	mA		
				$T_a = 75^\circ C$	-	-145	-			

● AC CHARACTERISTICS ($V_{EE} = -5.2V \pm 5\%$, $T_a = 0$ to $+75^\circ C$, air flow exceeding 2m/sec)

1. READ MODE

Item	Symbol	Test Condition	min	typ	max	Unit
Chip Select Access Time	t_{ACS}		-	-	8	ns
Chip Select Recovery Time	t_{RCS}		-	-	8	ns
Address Access Time	t_{AA}		-	-	15	ns

2. WRITE MODE

Item	Symbol	Test Condition	min	typ	max	Unit
Write Pulse Width	t_w	$t_{WSA} = 3ns$	15	-	-	ns
Data Setup Time	t_{WSD}		2	-	-	ns
Data Hold Time	t_{WHD}		2	-	-	ns
Address Setup Time	t_{WSA}		$t_w = 15ns$	3	-	-
Address Hold Time	t_{WHA}		2	-	-	ns
Chip Select Setup Time	t_{WSCS}		2	-	-	ns
Chip Select Hold Time	t_{WHCS}		2	-	-	ns
Write Disable Time	t_{WS}		-	-	8	ns
Write Recovery Time	t_{WR}		-	-	8	ns

3. RISE/FALL TIME

Item	Symbol	Test Condition	min	typ	max	Unit
Output Rise Time	t_r		—	2	—	ns
Output Fall Time	t_f		—	2	—	ns

4. CAPACITANCE

Item	Symbol	Test Condition	min	typ	max	Unit
Input Capacitance	C_{in}		—	3	—	pF
Output Capacitance	C_{out}		—	5	—	pF

■ TEST CIRCUIT AND WAVEFORMS

1. LOADING CONDITION

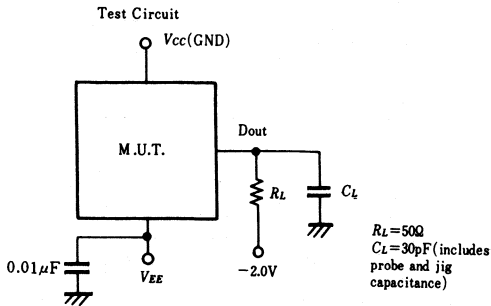

2. INPUT PULSE

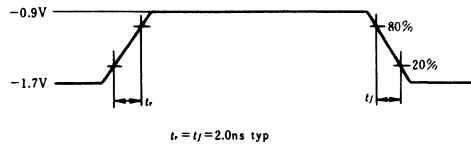

3. READ MODE

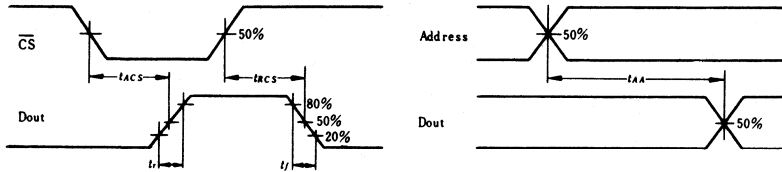

4. WRITE MODE

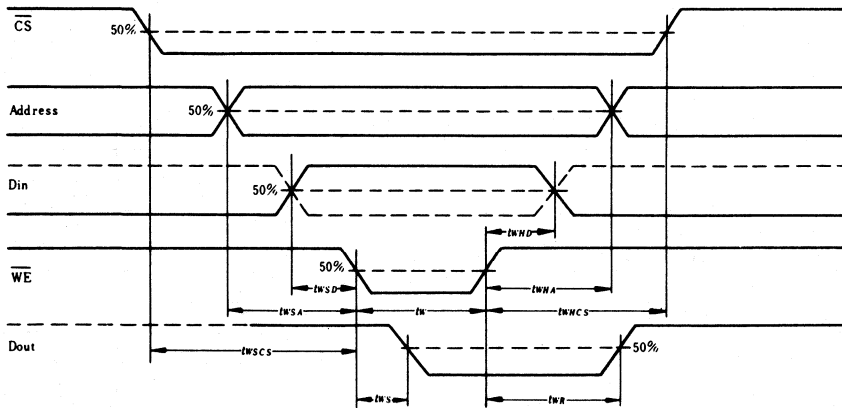

HM2142

4096-words × 1-bit Very High Speed Random Access Memory

The HM2142 is 4096-words x 1-bit very high speed read/write, random access memory developed for high speed systems such as pads and control/buffer storages.

The fabrication process uses the Hitachi's low capacitance, oxide isolation method with double metalization.

The HM2142 is encapsulated in cerdip-20 pin package.

FEATURES

- 4096-words x 1 bit organization
- Very high speed address access time: 10ns (max)
- Write pulse width: 10ns (min)
- Power dissipation: 0.3 mW/bit
- Output obtainable by wired-OR

TRUTH TABLE

Input			Output	Mode
C S	WE	Din		
H	×	×	L	Not Selected
L	L	L	L	Write "0"
L	L	H	L	Write "1"
L	H	×	Dout *	Read

Notes) × : Irrelevant
* : Read Out Noninvert

BLOCK DIAGRAM

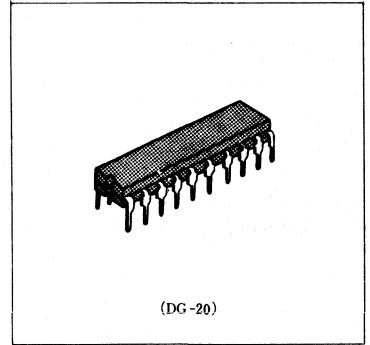
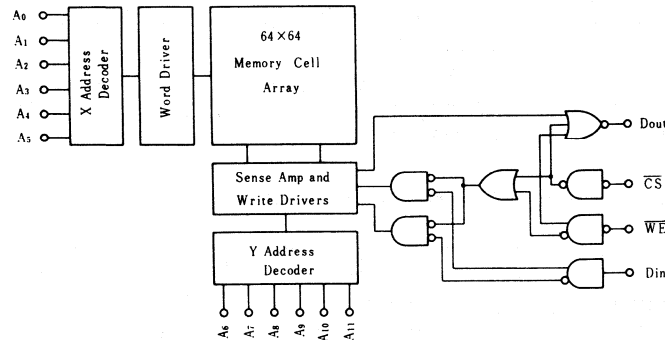

PIN ARRANGEMENT

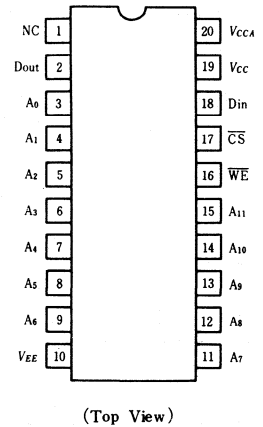

■ ABSOLUTE MAXIMUM RATINGS ($T_a=25^\circ\text{C}$)

Item	Symbol	Rating	Unit
Supply Voltage	V_{EE} to V_{CC}	+0.5 to -7.0	V
Input Voltage	V_{in}	+0.5 to V_{EE}	V
Output Current	I_{out}	-30	mA
Storage Temperature	T_{stg}	-65 to +150	$^\circ\text{C}$
Storage Temperature	$T_{stg}(\text{Bias})^*$	-55 to +125	$^\circ\text{C}$

* Under Bias

■ ELECTRICAL CHARACTERISTICS

● DC CHARACTERISTICS ($V_{EE}=-5.2\text{V}$, $R_L=50\Omega$ to -2.0V , $T_a=0$ to $+75^\circ\text{C}$, air flow exceeding 2m/sec)

Item	Symbol	Test Condition	min(B)	typ	max(A)	Unit		
Output Voltage	V_{OH}	$V_{IH}=V_{IHA}$ or V_{ILB}	0°C	-1000	—	-840	mV	
			$+25^\circ\text{C}$	-980	—	-810		
			$+75^\circ\text{C}$	-950	—	-720		
	V_{OL}		0°C	-1870	—	-1665		
			$+25^\circ\text{C}$	-1850	—	-1650		
			$+75^\circ\text{C}$	-1830	—	-1625		
Output Threshold Voltage	V_{OHC}	$V_{IH}=V_{IHB}$ or V_{ILA}	0°C	-1020	—	—	mV	
			$+25^\circ\text{C}$	-980	—	—		
			$+75^\circ\text{C}$	-920	—	—		
	V_{OLC}		0°C	—	—	-1645		
			$+25^\circ\text{C}$	—	—	-1630		
			$+75^\circ\text{C}$	—	—	-1605		
Input Voltage	V_{IH}	Guaranteed Input Voltage High for All Inputs	0°C	-1165	—	-880	mV	
			$+25^\circ\text{C}$	-1165	—	-880		
			$+75^\circ\text{C}$	-1165	—	-880		
	V_{IL}		Guaranteed Input Voltage Low for All Inputs	0°C	-1810	—		-1560
				$+25^\circ\text{C}$	-1810	—		-1560
				$+75^\circ\text{C}$	-1810	—		-1560
Input Current	I_{IH}	$V_{IN}=V_{IHA}$		0 to $+75^\circ\text{C}$	—	—	220	μA
					$\overline{\text{CS}}$	$V_{IN}=V_{ILB}$	0.5	
	I_{IL}			Others	—		—	
			—		—	—		
Supply Current	I_{EE}	All Input and Output Open.	$T_a=0^\circ\text{C}$	-270	-240	—	mA	
			$T_a=75^\circ\text{C}$	—	-220	—		

● AC CHARACTERISTICS ($V_{EE}=-5.2\text{V}\pm 5\%$, $T_a=0$ to $+75^\circ\text{C}$, air flow exceeding 2m/sec)

1. READ MODE

Item	Symbol	Test Condition	min	typ	max	Unit
Chip Select Access Time	t_{ACS}		—	—	6	ns
Chip Select Recovery Time	t_{RCS}		—	—	6	ns
Address Access Time	t_{AA}		—	—	10	ns

2. WRITE MODE

Item	Symbol	Test Condition	min	typ	max	Unit
Write Pulse Width	t_w	$t_{wSA}=3\text{ns}$	10	—	—	ns
Data Setup Time	t_{WSD}		1	—	—	ns
Data Hold Time	t_{WHD}		1	—	—	ns
Address Setup Time	t_{wSA}	$t_w=10\text{ns}$	3	—	—	ns
Address Hold Time	t_{wHA}		2	—	—	ns
Chip Select Setup Time	t_{wSCS}		1	—	—	ns
Chip Select Hold Time	t_{wHCS}		1	—	—	ns
Write Disable Time	t_{wS}		—	—	6	ns
Write Recovery Time	t_{wN}		—	—	6	ns

HM10474, HM10474-15

1024-word × 4-bit Fully Decoded Random Access Memory

The HM10474 is ECL 10k compatible, 1024-words x 4-bit, read write, random access memory developed for high speed systems such as scratch pads and control/buffer storages.

The fabrication process is the Hitachi's low capacitance, oxide isolation method with double metalization.

The HM10474 is encapsulated in cerdip-24pin package, compatible with Fairchild's F10474.

■ FEATURES

- 1024-word x 4-bit organization
- Fully compatible with 10K ECL level
- Address access time: HM10474 25ns (max)
HM10474-15 15ns (max)
- Write pulse width: HM10474 25ns(min)
HM10474-15 15ns (min)
- Low power dissipation: 0.2mW/bit
- Output obtainable by wired-OR (open emitter)

■ TRUTH TABLE

Input			Output	Mode
\overline{CS}	\overline{WE}	Din		
H	×	×	L	Not Selected
L	L	L	L	Write "0"
L	L	H	L	Write "1"
L	H	×	Dout*	Read

Notes) × : Irrelevant

* : Read Out Noninvert

■ BLOCK DIAGRAM

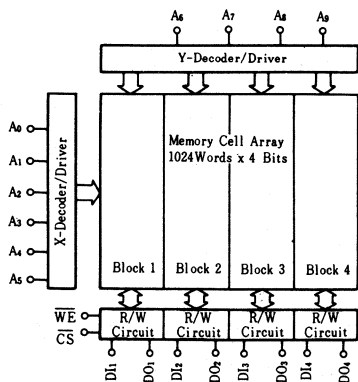

■ ABSOLUTE MAXIMUM RATINGS ($T_a = 25^\circ\text{C}$)

Item	Symbol	Rating	Unit
Supply Voltage	V_{EE} to V_{CC}	+0.5 to -7.0	V
Input Voltage	V_{in}	+0.5 to V_{EE}	V
Output Current	I_{out}	-30	mA
Storage Temperature	T_{stg}	-65 to +150	$^\circ\text{C}$
Storage Temperature	$T_{stg}(\text{Bias})^*$	-55 to +125	$^\circ\text{C}$

* Under Bias

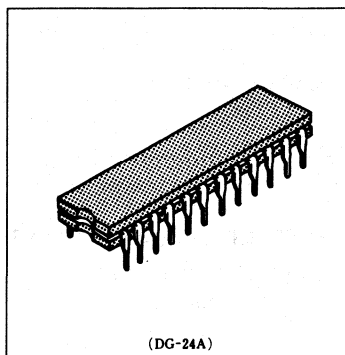

■ PIN ARRANGEMENT

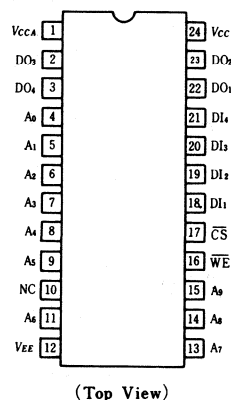

(Top View)

■ ELECTRICAL CHARACTERISTICS

● DC CHARACTERISTICS ($V_{EE} = -5.2V$, $R_L = 50\Omega$ to $-2.0V$, $T_a = 0$ to $+75^\circ C$, air flow exceeding 2m/sec)

Item	Symbol	Test Condition		min (B)	typ	max (A)	Unit			
Output Voltage	V_{OH}	$V_{IN} = V_{IH A}$ or $V_{IL B}$		0°C	-1000	-	-840	mV		
				+25°C	-960	-	-810			
				+75°C	-900	-	-720			
	V_{OL}			0°C	-1870	-	-1665			
				+25°C	-1850	-	-1650			
				+75°C	-1830	-	-1625			
Output Threshold Voltage	V_{OHC}	$V_{IN} = V_{IH B}$ or $V_{IL A}$		0°C	-1020	-	-	mV		
				+25°C	-980	-	-			
				+75°C	-920	-	-			
	V_{OLC}			0°C	-	-	-1645			
				+25°C	-	-	-1630			
				+75°C	-	-	-1605			
Input Voltage	V_{IH}	Guaranteed Input Voltage High for All Inputs		0°C	-1145	-	-840	mV		
				+25°C	-1105	-	-810			
				+75°C	-1045	-	-720			
	V_{IL}			Guaranteed Input Voltage Low for All Inputs		0°C	-1870		-	-1490
						+25°C	-1850		-	-1475
						+75°C	-1830		-	-1450
Input Current	I_{IH}	$V_{IN} = V_{IH A}$	0 to +75°C			-	-	220	μA	
	I_{IL}	\overline{CS}	$V_{IN} = V_{IL B}$			0 to +75°C	0.5	-		170
		Others				-	-	-		
Supply Current	I_{EE}	All Input and Output Open, Test Pin 12		$T_a = 0^\circ C$	-200	-160	-	mA		
				$T_a = 75^\circ C$	-	-145	-			

● AC CHARACTERISTICS ($V_{EE} = -5.2V \pm 5\%$, $T_a = 0$ to $+75^\circ C$, air flow exceeding 2m/sec)

1. READ MODE

Item	Symbol	Test Condition	HM10474			HM10474-15			Unit
			min	typ	max	min	typ	max	
Chip Select Access Time	t_{ACS}		-	-	10	-	-	8	ns
Chip Select Recovery Time	t_{RCS}		-	-	10	-	-	8	ns
Address Access Time	t_{AA}		-	15	25	-	-	15	ns

2. WRITE MODE

Item	Symbol	Test Condition	HM10474			HM10474-15			Unit
			min	typ	max	min	typ	max	
Write Pulse Width	t_W	$t_{WSA} = 3ns$	25	15	-	15	-	-	ns
Data Setup Time	t_{WSD}		2	-	-	2	-	-	ns
Data Hold Time	t_{WHD}		2	-	-	2	-	-	ns
Address Setup Time	t_{WSA}	$t_W = t_{Wmin}$	3	-	-	3	-	-	ns
Address Hold Time	t_{WHA}		2	-	-	2	-	-	ns
Chip Select Setup Time	t_{WSCS}		2	-	-	2	-	-	ns
Chip Select Hold Time	t_{WHCS}		2	-	-	2	-	-	ns
Write Disable Time	t_{WS}		-	-	10	-	-	8	ns
Write Recovery Time	t_{WR}		-	-	10	-	-	8	ns

3. RISE/FALL TIME

Item	Symbol	Test Condition	min	typ	max	Unit
Output Rise Time	t_r		—	2	—	ns
Output Fall Time	t_f		—	2	—	ns

4. CAPACITANCE

Item	Symbol	Test Condition	min	typ	max	Unit
Input Capacitance	C_{in}		—	4	—	pF
Output Capacitance	C_{out}		—	7	—	pF

■ TEST CIRCUIT AND WAVEFORMS

1. LOADING CONDITION

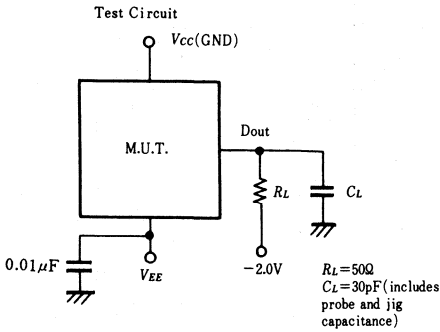

2. INPUT PULSE

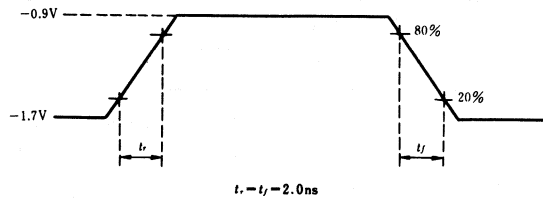

3. READ MODE

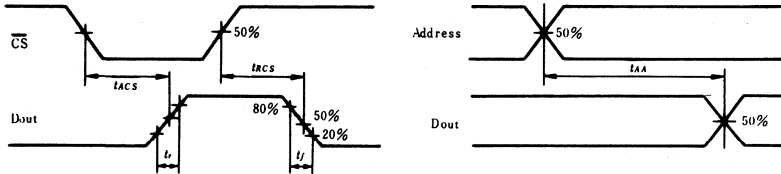

4. WRITE MODE

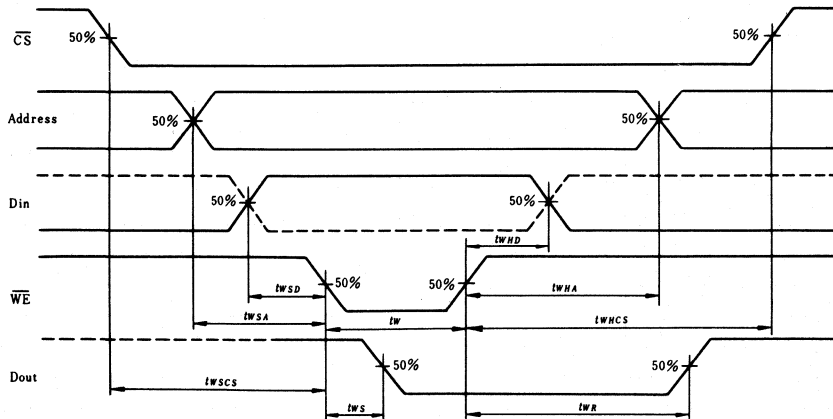

SUPPLY CURRENT vs. AMBIENT TEMPERATURE

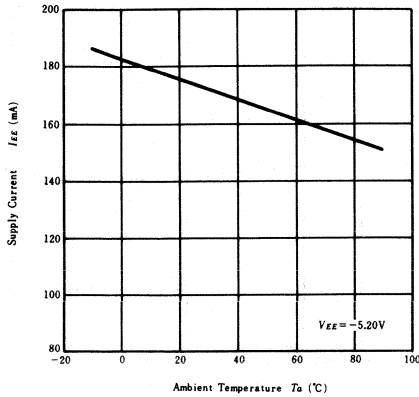

SUPPLY CURRENT vs. SUPPLY VOLTAGE

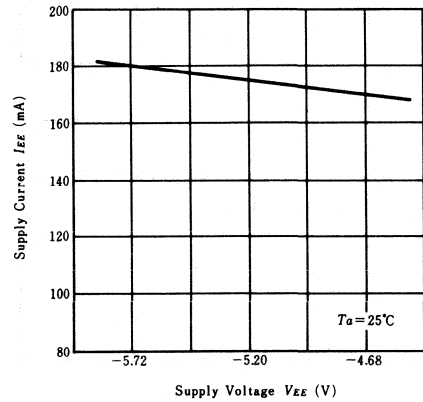

ADDRESS ACCESS TIME vs. AMBIENT TEMPERATURE

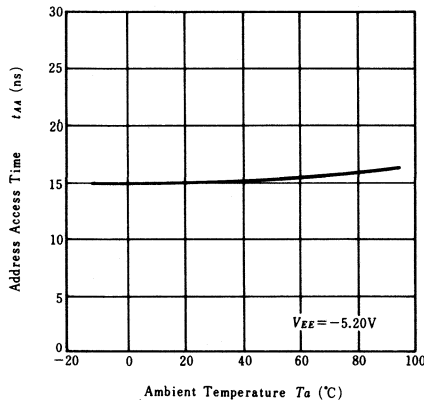

ADDRESS ACCESS TIME vs. SUPPLY VOLTAGE

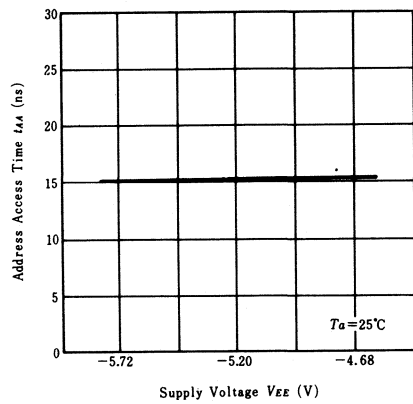

CHIP SELECT ACCESS TIME vs. AMBIENT TEMPERATURE

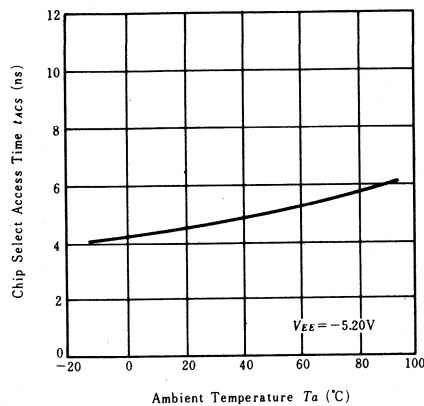

CHIP SELECT ACCESS TIME vs. SUPPLY VOLTAGE

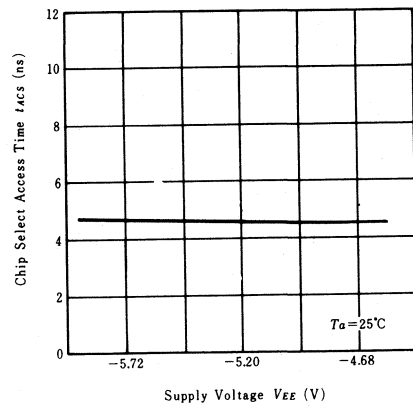

**WRITE PULSE WIDTH vs.
AMBIENT TEMPERATURE**

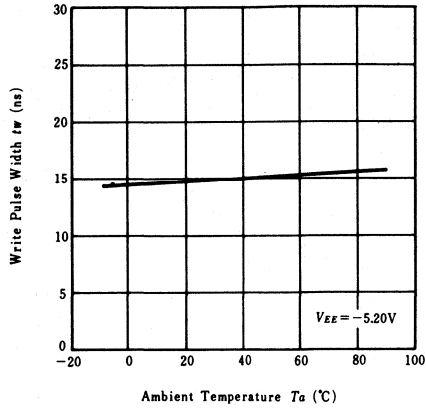

**WRITE PULSE WIDTH vs.
SUPPLY VOLTAGE**

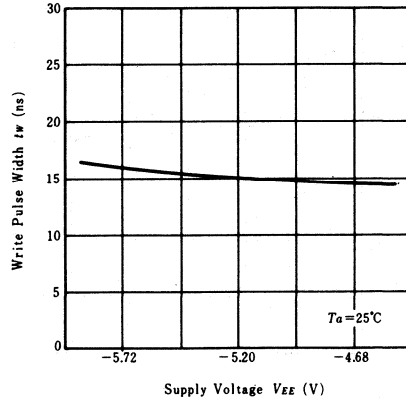

HM10480, HM10480F

16,384-words × 1-bit Fully Decoded Random Access Memory

The HM10480 is ECL 10K compatible, 16,384-words x 1-bit, read/write random access memory developed for high speed systems such as scratch pads and control/buffer storages.

The fabrication process uses the Hitachi's low capacitance, oxide isolation method with double metalization.

The HM10480 is encapsulated in cerdip-20 pin and flat 20-pin package, compatible with Fairchild's F10480.

FEATURES

- 16,384-words x 1-bit organization
- Fully compatible with 10K ECL level
- Address access time: 25ns (max)
- Write pulse width: 25ns(min)
- Low power dissipation: 0.05mW/bit
- Output obtainable by wired-OR (open emitter)

TRUTH TABLE

CS	Input		Output	Mode
	WE	Din		
H	×	×	L	Not Selected
L	L	L	L	Write "0"
L	L	H	L	Write "1"
L	H	×	Dout*	Read

Notes) × : Irrelevant
* : Read Out Noninvert

BLOCK DIAGRAM

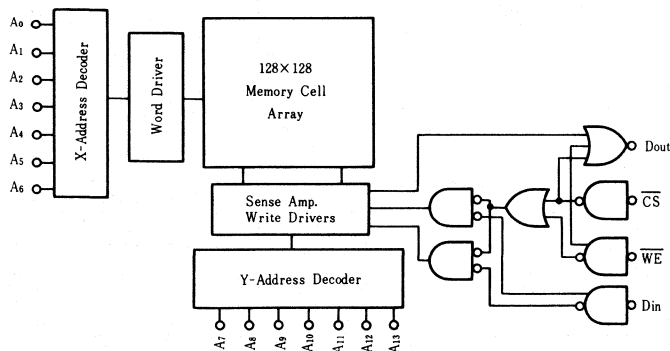

ABSOLUTE MAXIMUM RATINGS ($T_a = 25^\circ\text{C}$)

Item	Symbol	Rating	Unit
Supply Voltage	V_{EE} to V_{CC}	+0.5 to -7.0	V
Input Voltage	V_{in}	+0.5 to V_{EE}	V
Output Current	I_{out}	-30	mA
Storage Temperature	T_{stg}	-65 to +150	$^\circ\text{C}$
Storage Temperature	$T_{stg}(\text{Bias})^*$	-55 to +125	$^\circ\text{C}$

* Under Bias

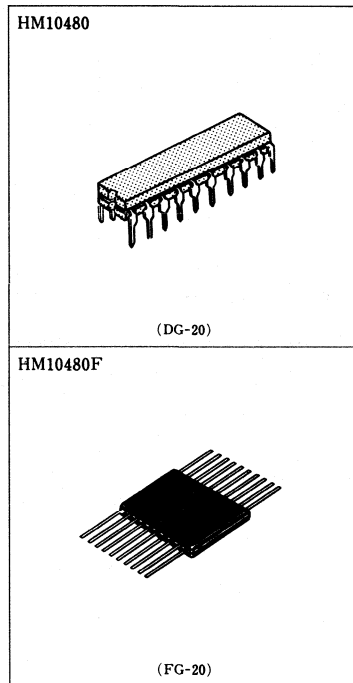

PIN ARRANGEMENT

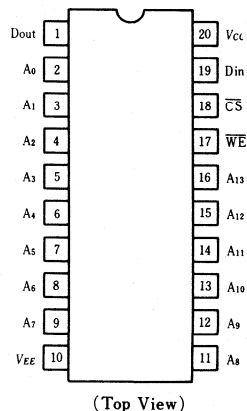

■ ELECTRICAL CHARACTERISTICS

● DC CHARACTERISTICS ($V_{EE} = -5.2V$, $R_L = 50\Omega$ to $-2.0V$, $T_a = 0$ to $+75^\circ C$, air flow exceeding 2m/sec)

Item	Symbol	Test Condition	min(B)	typ	max(A)	Unit		
Output Voltage	V_{OH}	$V_{IN} = V_{IH A}$ or $V_{IL B}$	0°C	-1000	—	-840	mV	
			+25°C	-960	—	-810		
			+75°C	-900	—	-720		
	V_{OL}		0°C	-1870	—	-1665		
			+25°C	-1850	—	-1650		
			+75°C	-1830	—	-1625		
Output Threshold Voltage	V_{OHC}	$V_{IN} = V_{IH B}$ or $V_{IL A}$	0°C	-1020	—	—	mV	
			+25°C	-980	—	—		
			+75°C	-920	—	—		
	V_{OLC}		0°C	—	—	-1645		
			+25°C	—	—	-1630		
			+75°C	—	—	-1605		
Input Voltage	V_{IH}	Guaranteed Input Voltage High for All Inputs	0°C	-1145	—	-840	mV	
			+25°C	-1105	—	-810		
			+75°C	-1045	—	-720		
	V_{IL}		0°C	-1870	—	-1490		
			+25°C	-1850	—	-1475		
			+75°C	-1830	—	-1450		
Input Current	I_{IH}	$V_{IN} = V_{IH A}$	0 to +75°C	—	—	220	μA	
	I_{IL}	\overline{CS}	$V_{IN} = V_{IL B}$	0 to +75°C	0.5	—		170
		Others		—	—	—		
Supply Current	I_{EE}	All Input and Output Open, Test Pin 10	$T_a = 0^\circ C$	-170	-140	—	mA	
			$T_a = 75^\circ C$	—	-130	—		

● AC CHARACTERISTICS ($V_{EE} = -5.2V \pm 5\%$, $T_a = 0$ to $+75^\circ C$, air flow exceeding 2m/sec)

1. READ MODE

Item	Symbol	Test Condition	min	typ	max	Unit
Chip Select Access Time	t_{ACS}		2	—	10	ns
Chip Select Recovery Time	t_{RCS}		2	—	10	ns
Address Access Time	t_{AA}		3	15	25	ns

2. WRITE MODE

Item	Symbol	Test Condition	min	typ	max	Unit
Write Pulse Width	t_W	$t_{WSA} = 5ns$	25	—	—	ns
Data Setup Time	t_{WSD}		5	—	—	ns
Data Hold Time	t_{WHD}		5	—	—	ns
Address Setup Time	t_{WSA}		$t_W = 25ns$	5	—	—
Address Hold Time	t_{WHA}		5	—	—	ns
Chip Select Setup Time	t_{WSCS}		5	—	—	ns
Chip Select Hold Time	t_{WHCS}		5	—	5	ns
Write Disable Time	t_{WS}		—	—	10	ns
Write Recovery Time	t_{WR}		—	—	10	ns

3. RISE/FALL TIME

Item	Symbol	Test Condition	min	typ	max	Unit
Output Rise Time	t_r		—	2	—	ns
Output Fall Time	t_f		—	2	—	ns

4. CAPACITANCE

Item	Symbol	Test Condition	min	typ	max	Unit
Input Capacitance	C_{in}		—	4	—	pF
Output Capacitance	C_{out}		—	7	—	pF

■ TEST CIRCUIT AND WAVEFORMS

1. LOADING CONDITION

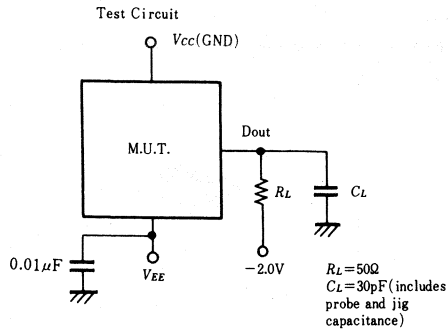

2. INPUT PULSE

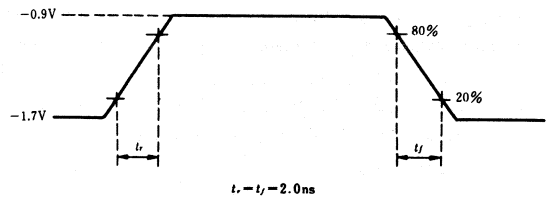

3. READ MODE

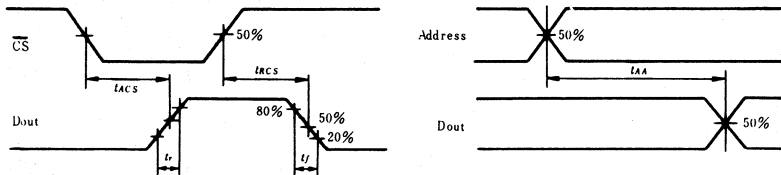

4. WRITE MODE

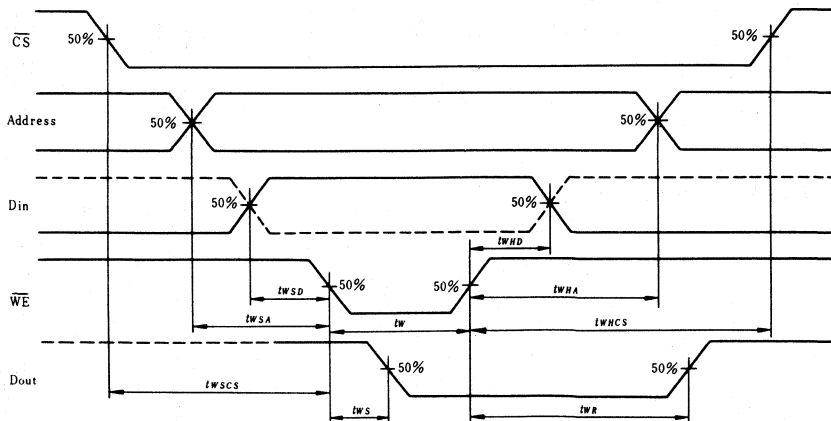

HM100415, HM100415CC

1024-word × 1-bit Fully Decoded Random Access Memory

The HM100415 is a 1024-word x 1-bit, read/write random access memory developed for application to scratch pads, control and buffer storages which require very high speeds.

The HM100415 is compatible with the HD100K families and includes on-chip voltage and temperature compensation for improved noise margin. This memory is encapsulated in cerdip-16pin package.

FEATURES

- Level 100K ECL Compatible
- Organization 1024-word by 1-bit
- Address Access Time 10ns (max)
- Chip Select Access Time 5ns (max.)
- Power Consumption 0.6mW/bit (typ)
- Output Obtainable by Wired-OR (open emitter)
- Compatible with Fairchild F100415.

TRUTH TABLE

Input			Output	Mode
CS	WE	Din		
H	×	×	L	Not Selected
L	L	L	L	Write "0"
L	L	H	L	Write "1"
L	H	×	Dout*	Read

Notes) × : Irrelevant
* : Read Out Noninvert

BLOCK DIAGRAM

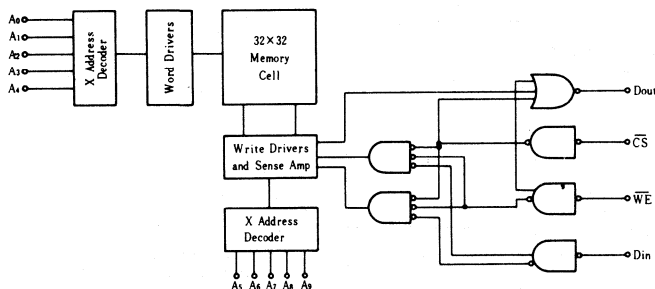

ABSOLUTE MAXIMUM RATINGS (Ta = 25°C)

Item	Symbol	Rating	Unit
Supply Voltage	V _{EE} to V _{CC}	+0.5 to -7.0	V
Input Voltage	V _{in}	+0.5 to V _{EE}	V
Output Current	I _{out}	-30	mA
Storage Temperature	T _{stg}	-65 to +150	°C
Storage Temperature	T _{stg} (Bias)*	-55 to +125	°C

* Under Bias

HM100415

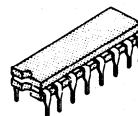

(DG-16A)

HM100415CC

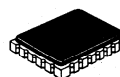

(CC-24)

PIN ARRANGEMENT

HM100415

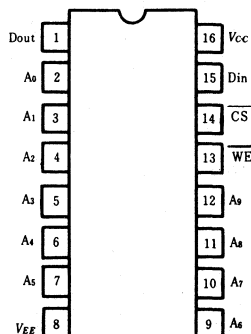

(Top View)

HM100415CC

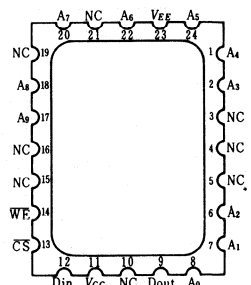

(Top View)

■ ELECTRICAL CHARACTERISTICS

● DC CHARACTERISTICS ($V_{EE} = -4.5V$, $R_L = 50\Omega$ to $-2.0V$, $T_a = 0$ to $+85^\circ C$, air flow exceeding 2m/sec)

Item	Symbol	Test Condition	min(B)	typ	max(A)	Unit	
Output Voltage	V_{OH}	$V_{in} = V_{IH}$ or V_{ILB}	-1025	-955	-880	mV	
	V_{OL}		-1810	-1715	-1620	mV	
Output Threshold Voltage	V_{OHC}	$V_{in} = V_{IH}$ or V_{ILA}	-1035	—	—	mV	
	V_{OLC}		—	—	-1610	mV	
Input Voltage	V_{IH}	Guaranteed Input Voltage	-1165	—	-880	mV	
	V_{IL}	High/Low for All Inputs	-1810	—	-1475	mV	
Input Current	I_{IH}	$V_{in} = V_{IH}$	—	—	220	μA	
	I_{IL}	$V_{in} = V_{ILB}$	\overline{CS}	0.5	—	170	μA
			Others	-50	—	—	μA
Supply Current	I_{EE}	All Inputs and Outputs Open	-200	-150	—	mA	

● AC CHARACTERISTICS ($V_{EE} = -4.5V \pm 5\%$, $T_a = 0$ to $+85^\circ C$, air flow exceeding 2m/sec)

1. READ MODE

Item	Symbol	Test Condition	min	typ	max	Unit
Chip Select Access Time	t_{ACS}		—	3	5	ns
Chip Select Recovery Time	t_{RCS}		—	3	5	ns
Address Access Time	t_{AA}		—	7	10	ns

2. WRITE MODE

Item	Symbol	Test Condition	min	typ	max	Unit
Write Pulse Width	t_w	$t_{WSA} = 2ns$	6	4	—	ns
Data Setup Time	t_{WSD}		2	0	—	ns
Data Hold Time	t_{WHD}		2	0	—	ns
Address Setup Time	t_{WSA}		$t_w = 6ns$	2	0	—
Address Hold Time	t_{WHA}		2	0	—	ns
Chip Select Setup Time	t_{WSCS}		2	0	—	ns
Chip Select Hold Time	t_{WHCS}		2	0	—	ns
Write Disable Time	t_{WS}		—	3	5	ns
Write Recovery Time	t_{WR}		—	3	5	ns

3. RISE/FALL TIME

Item	Symbol	Test Condition	min	typ	max	Unit
Output Rise Time	t_r		—	2	—	ns
Output Fall Time	t_f		—	2	—	ns

4. CAPACITANCE

Item	Symbol	Test Condition	min	typ	max	Unit
Input Capacitance	C_{in}		—	3	—	pF
Output Capacitance	C_{out}		—	5	—	pF

■ TEST CIRCUIT AND WAVEFORMS

1. LOADING CONDITION

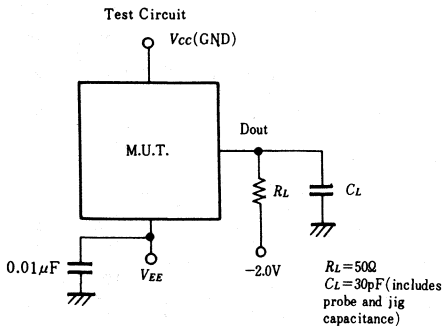

2. INPUT PULSE

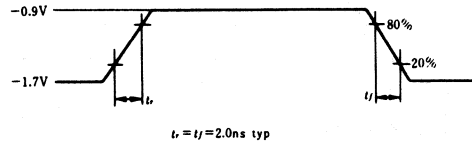

3. READ MODE

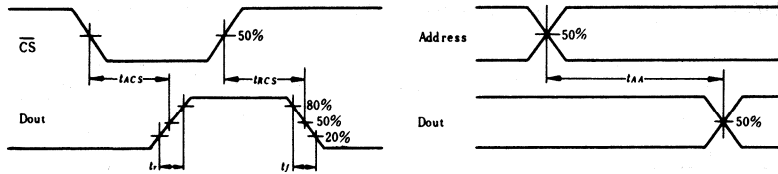

4. WRITE MODE

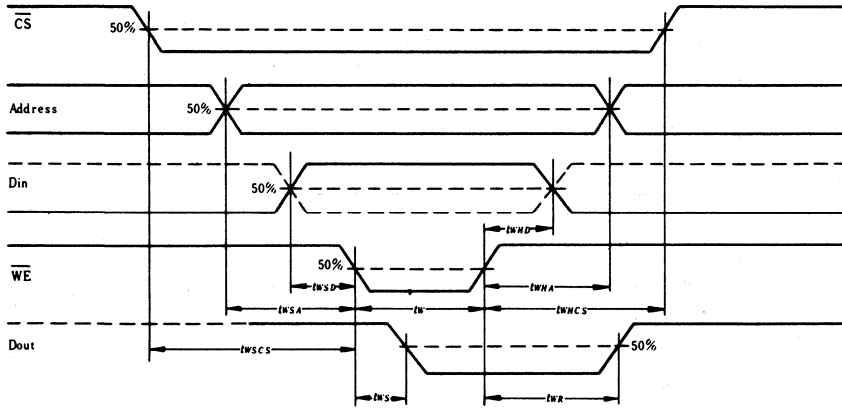

HM100422, HM100422F HM100422CC

256-word × 4-bit Fully Decoded Random Access Memory

The HM100422 is ECL 100K compatible, 256-word x 4-bit, read write, random access memory developed for high speed system such as scratch pads and control/buffer storages.

Four active Low Block Select lines are provided to select each block independently.

The fabrication process is the Hitachi's low capacitance, oxide isolation method with double metalization.

The HM100422 is encapsulated in cerdip-24pin package, or 24pin flat package compatible with Fairchild's F100422.

FEATURES

- 256-word x 4-bit organization
- Fully compatible with 100K ECL level
- Address access time: 10ns (max.)
- Minimum write pulse width: 6ns (min.)
- Low power dissipation: 0.8mW/bit
- Output obtainable by wired-OR (open emitter)

TRUTH TABLE

Input			Output	Mode
\overline{BS}	\overline{WE}	Din		
H	×	×	L	Not Selected
L	L	L	L	Write "0"
L	L	H	L	Write "1"
L	H	×	Dout*	Read

Notes) × : Irrelevant

* : Read Out Noninvert

BLOCK DIAGRAM

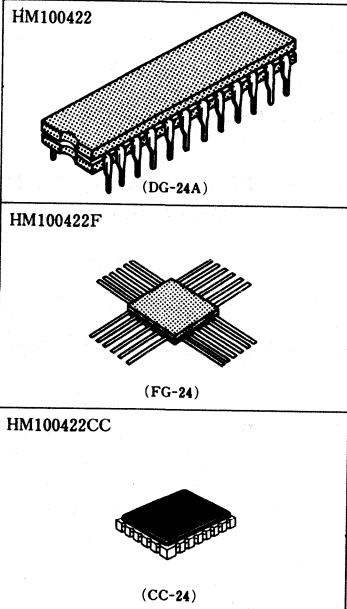
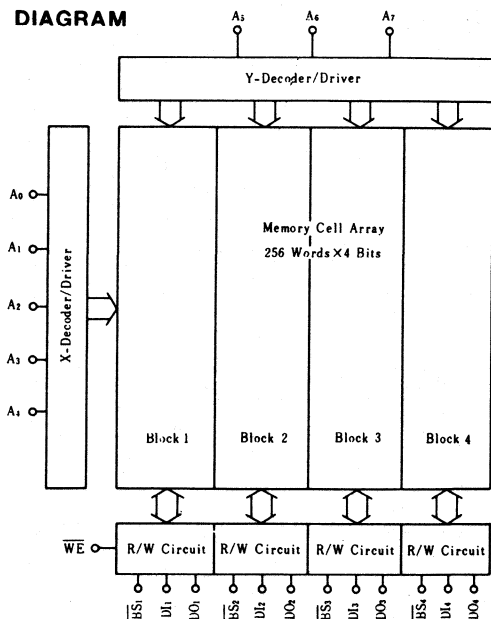

PIN ARRANGEMENT

HM100422

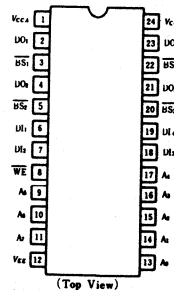

HM100422F

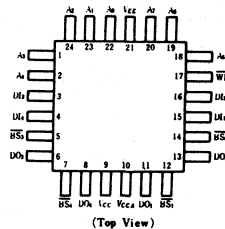

HM100422CC

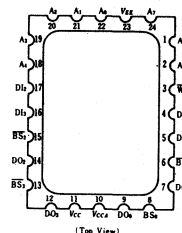

■ ABSOLUTE MAXIMUM RATINGS ($T_a=25^{\circ}\text{C}$)

Item	Symbol	Rating	Unit
Supply Voltage	V_{EE} to V_{CC}	+0.5 to -7.0	V
Input Voltage	V_{in}	+0.5 to V_{EE}	V
Output Current	I_{out}	-30	mA
Storage Temperature	T_{stg}	-65 to +150	$^{\circ}\text{C}$
Storage Temperature	$T_{stg}(\text{Bias})^*$	-55 to +125	$^{\circ}\text{C}$

* Under Bias

■ ELECTRICAL CHARACTERISTICS

● DC CHARACTERISTICS ($V_{EE}=-4.5\text{V}$, $R_L=50\Omega$ to -2.0V , $T_a=0$ to $+85^{\circ}\text{C}$, air flow exceeding 2m/sec)

Item	Symbol	Test Condition	min(B)	typ	max(A)	Unit
Output Voltage	V_{OH}	$V_{in}=V_{IHA}$ or V_{ILB}	-1025	-955	-880	mV
	V_{OL}		-1810	-1715	-1620	mV
Output Threshold Voltage	V_{OHC}	$V_{in}=V_{IHB}$ or V_{ILA}	-1035	—	—	mV
	V_{OLC}		—	—	-1610	mV
Input Voltage	V_{IH}	Guaranteed Input Voltage	-1165	—	-880	mV
	V_{IL}	High/Low for All Inputs	-1810	—	-1475	mV
Input Current	I_{IH}	$V_{in}=V_{IHA}$	—	—	220	μA
	I_{IL}	$V_{in}=V_{ILB}$	$\overline{\text{BS}}$	0.5	—	170
Others			-50	—	—	
Supply Current	I_{EE}	All Inputs and Outputs Open	-200	-165	—	mA

● AC CHARACTERISTICS ($V_{EE}=-4.5\text{V} \pm 5\%$, $T_a=0$ to $+85^{\circ}\text{C}$, air flow exceeding 2m/sec)

1. READ MODE

Item	Symbol	Test Condition	min	typ	max	Unit
Block Select Access Time	t_{ABS}		—	—	5	ns
Block Select Recovery Time	t_{RBS}		—	—	5	ns
Address Access Time	t_{AA}		—	7	10	ns

2. WRITE MODE

Item	Symbol	Test Condition	min	typ	max	Unit
Write Pulse Width	t_w	$t_{WSA}=2\text{ns}$	6	4.5	—	ns
Data Setup Time	t_{WSD}		2	0	—	ns
Data Hold Time	t_{WHD}		2	0	—	ns
Address Setup Time	t_{WSA}		$t_w=6\text{ns}$	2	0	—
Address Hold Time	t_{WHA}		2	0	—	ns
Block Select Setup Time	t_{WSBS}		2	0	—	ns
Block Select Hold Time	t_{WHBS}		2	0	—	ns
Write Disable Time	t_{WS}		—	4	5	ns
Write Recovery Time	t_{WR}		—	4.5	9	ns

3. RISE/FALL TIME

Item	Symbol	Test Condition	min	typ	max	Unit
Output Rise Time	t_r		—	2	—	ns
Output Fall Time	t_f		—	2	—	ns

4. CAPACITANCE

Item	Symbol	Test Condition	min	typ	max	Unit
Input Capacitance	C_{in}		—	4	—	pF
Output Capacitance	C_{out}		—	7	—	pF

■ TEST CIRCUIT AND WAVEFORMS

1. LOADING CONDITION

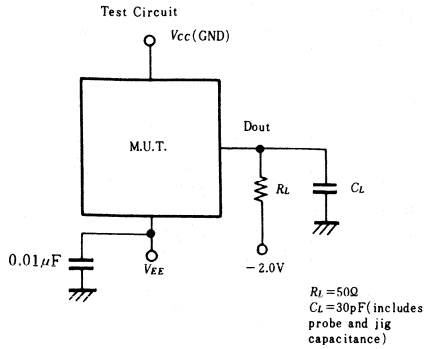

2. INPUT PULSE

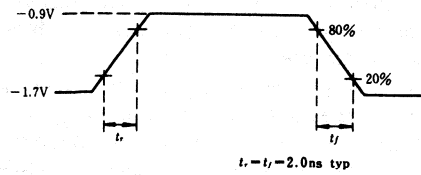

3. READ MODE

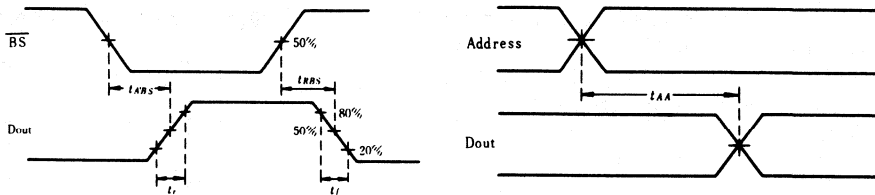

4. WRITE MODE

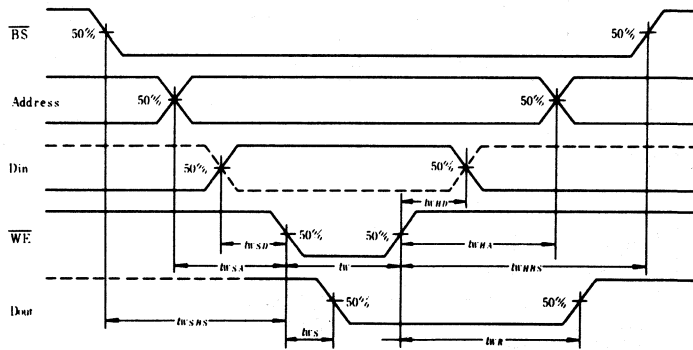

HM100470, HM100470-15

4096-word × 1-bit Fully Decoded Random Access Memory

The HM100470 is a 4096-words × 1-bit, read/write, random access memory developed for high speed systems such as scratch pads and control buffer storages.

The fabrication process is the Hitachi's low capacitance, oxide isolation method with double metalization.

The HM100470 is compatible with the HD100K ECL families and includes on-chip voltage and temperature compensation for improved noise margin. This device is encapsulated in cerdip-18pin package, compatible with Fairchild's F100470.

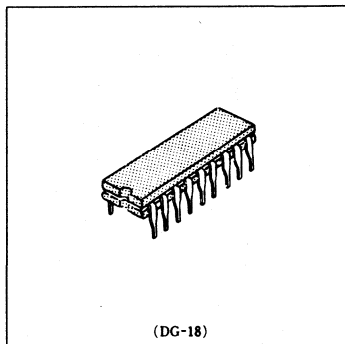

■ FEATURES

- 4096-word × 1-bit organization
- Full compatible with 100K ECL level
- Address access time: HM100470 25ns(max)
HM100470-15 15ns(max)
- Write pulse width: HM100470 25ns (min)
HM100470-15 15ns (min)
- Output obtainable by wired-OR (open emitter)

■ TRUTH TABLE

Input			Output	Mode
\overline{CS}	\overline{WE}	Din		
H	×	×	L	Not Selected
L	L	L	L	Write "0"
L	L	H	L	Write "1"
L	H	×	Dout*	Read

Notes) × : Irrelevant
* : Read Out Noninvert

■ PIN ARRANGEMENT

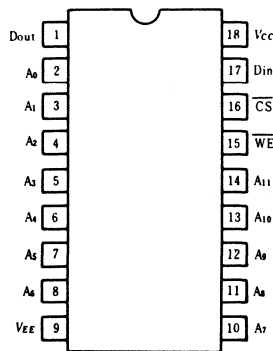

(Top View)

■ BLOCK DIAGRAM

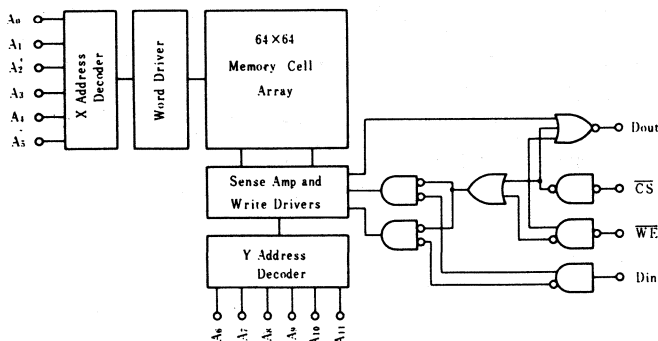

■ ABSOLUTE MAXIMUM RATINGS ($T_a = 25^\circ\text{C}$)

Item	Symbol	Rating	Unit
Supply Voltage	V_{EE} to V_{CC}	+0.5 to -7.0	V
Input Voltage	V_{in}	+0.5 to V_{EE}	V
Output Current	I_{out}	-30	mA
Storage Temperature	T_{stg}	-65 to +150	$^\circ\text{C}$
Storage Temperature	$T_{stg}(\text{Bias})^*$	-55 to +125	$^\circ\text{C}$

* Under Bias

■ ELECTRICAL CHARACTERISTICS

● DC CHARACTERISTICS ($V_{EE} = -4.5V$, $R_L = 50\Omega$ to $-2.0V$, $T_a = 0$ to $+85^\circ C$, air flow exceeding 2m/sec)

Item	Symbol	Test Condition	min(B)	typ	max(A)	Unit	
Output Voltage	V_{OH}	$V_{in} = V_{IHA}$ or V_{ILB}	-1025	-955	-880	mV	
	V_{OL}		-1810	-1715	-1620	mV	
Output Threshold Voltage	V_{OHC}	$V_{in} = V_{IHB}$ or V_{ILA}	-1035	—	—	mV	
	V_{OLC}		—	—	-1610	mV	
Input Voltage	V_{IH}	Guaranteed Input Voltage	-1165	—	-880	mV	
	V_{IL}	High/Low for All Inputs	-1810	—	-1475	mV	
Input Current	I_{IH}	$V_{in} = V_{IHA}$	—	—	220	μA	
	I_{IL}	$V_{in} = V_{ILB}$	CS	0.5	—	170	μA
			Others	-50	—	—	
Supply Current	I_{EE}	All Inputs and Outputs Open	-200	-165	—	mA	

● AC CHARACTERISTICS ($V_{EE} = -4.5V \pm 5\%$, $T_a = 0$ to $+85^\circ C$, air flow exceeding 2m/sec)

1. READ MODE

Item	Symbol	Test Condition	HM100470-15			HM100470			Unit
			min	typ	max	min	typ	max	
Chip Select Access Time	t_{ACS}		—	—	8	—	—	10	ns
Chip Select Recovery Time	t_{RCS}		—	—	8	—	—	10	ns
Address Access Time	t_{AA}		—	—	15	—	—	25	ns

2. WRITE MODE

Item	Symbol	Test Condition	HM100470-15			HM100470			Unit
			min	typ	max	min	typ	max	
Write Pulse Width	t_w	$t_{WSA} = 3ns$	15	—	—	25	—	—	ns
Data Setup Time	t_{WSD}		2	—	—	2	—	—	ns
Data Hold Time	t_{WHD}		2	—	—	2	—	—	ns
Address Setup Time	t_{WSA}	$t_w = t_{wmin}$	3	—	—	3	—	—	ns
Address Hold Time	t_{WHA}		2	—	—	2	—	—	ns
Chip Select Setup Time	t_{WSCS}		2	—	—	2	—	—	ns
Chip Select Hold Time	t_{WHCS}		2	—	—	2	—	—	ns
Write Disable Time	t_{WS}		—	—	8	—	—	10	ns
Write Recovery Time	t_{WR}		—	—	8	—	—	10	ns

3. RISE/FALL TIME

Item	Symbol	Test Condition	min	typ	max	Unit
Output Rise Time	t_r		—	2	—	ns
Output Fall Time	t_f		—	2	—	ns

4. CAPACITANCE

Item	Symbol	Test Condition	min	typ	max	Unit
Input Capacitance	C_{in}		—	3	—	pF
Output Capacitance	C_{out}		—	5	—	pF

■ TEST CIRCUIT AND WAVEFORMS

1. LOADING CONDITION

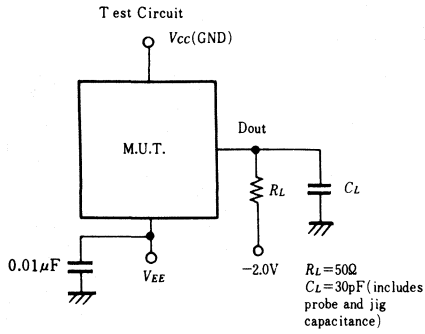

2. INPUT PULSE

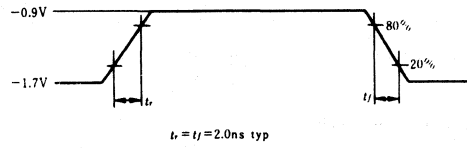

3. READ MODE

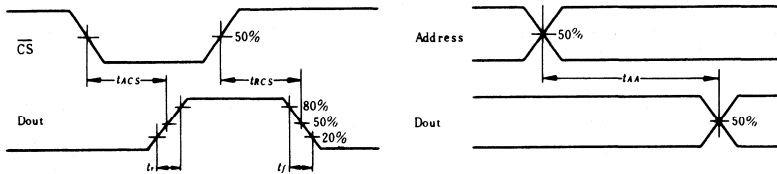

4. WRITE MODE

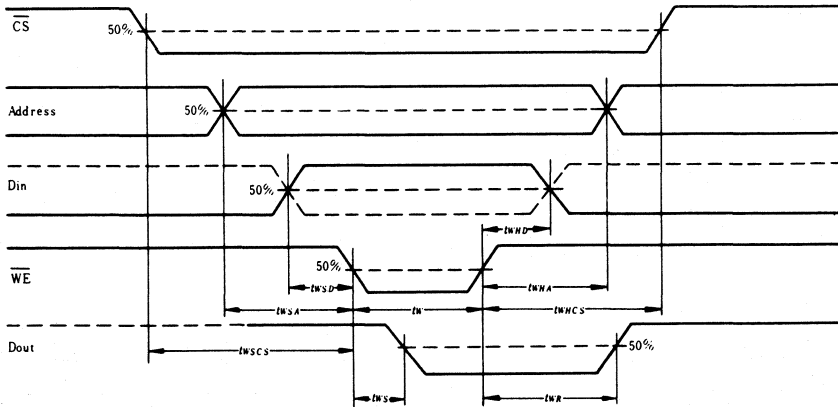

HM100474, HM100474-15 HM100474F, HM100474F-15

1024-word x 4-bit Fully Decoded Random Access Memory

The HM100474 is a 1024-words x 4-bit, read/write, random access memory developed for high speed systems such as scratch pads and control/buffer storages.

The fabrication process is the Hitachi's low capacitance, oxide isolation method with double metalization.

The HM100474 is compatible with the HD100K ECL families and includes on-chip voltage and temperature compensation for improved noise margin. This device is encapsulated in cerdip-24-pin and flat 24pin package, compatible with Fairchild's F100474.

■ FEATURES

- 1024-word x 4-bit organization
- Fully compatible with 100K ECL level
- Address access time: HM100474/F 25ns(max)
HM100474/F-15 15ns(max)
- Write pulse width: HM100474/F 25ns(min)
HM100474/F-15 15ns(min)
- Output obtainable by wired-OR (open emitter)

■ TRUTH TABLE

Input			Output	Mode
CS	WE	Din		
H	×	×	L	Not Selected
L	L	L	L	Write "0"
L	L	H	L	Write "1"
L	H	×	Dout*	Read

Notes) × : Irrelevant

* : Read Out Noninvert

■ BLOCK DIAGRAM

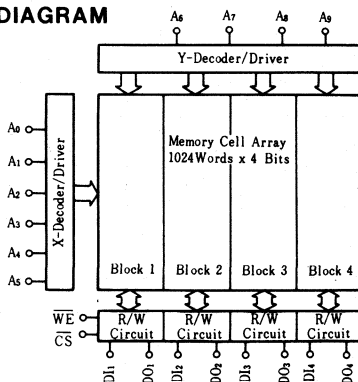

■ ABSOLUTE MAXIMUM RATINGS ($T_a = 25^\circ\text{C}$)

Item	Symbol	Rating	Unit
Supply Voltage	V_{EE} to V_{CC}	+0.5 to -7.0	V
Input Voltage	V_{in}	+0.5 to V_{EE}	V
Output Current	I_{out}	-30	mA
Storage Temperature	T_{stg}	-65 to +150	$^\circ\text{C}$
Storage Temperature	T_{stg} (Bias)*	-55 to +125	$^\circ\text{C}$

* Under Bias

HM100474, HM100474-15

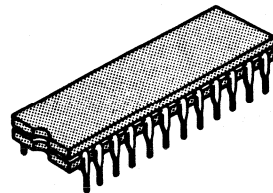

(DG-24A)

HM100474F, HM100474F-15

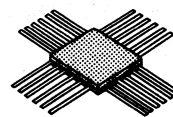

(FG-24)

■ PIN ARRANGEMENT

● HM100474, HM100474-15

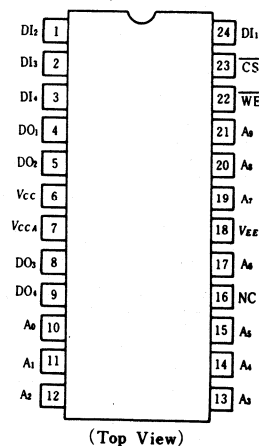

(Top View)

● HM100474F, HM100474F-15

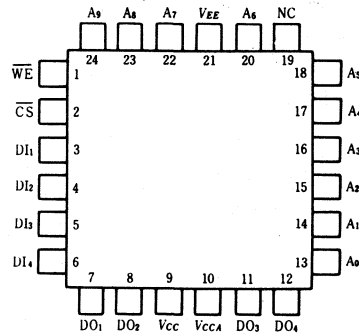

(Top View)

■ ELECTRICAL CHARACTERISTICS

● DC CHARACTERISTICS ($V_{EE} = -4.5V$, $R_L = 50\Omega$ to $-2.0V$, $T_a = 0$ to $+85^\circ C$, air flow exceeding 2m/sec)

Item	Symbol	Test Condition	min(B)	typ	max (A)	Unit	
Output Voltage	V_{OH}	$V_{in} = V_{IHA}$ or V_{ILB}	-1025	-955	-880	mV	
	V_{OL}		-1810	-1715	-1620	mV	
Output Threshold Voltage	V_{OHC}	$V_{in} = V_{IHB}$ or V_{ILA}	-1035	—	—	mV	
	V_{OLC}		—	—	-1610	mV	
Input Voltage	V_{IH}	Guaranteed Input Voltage	-1165	—	-880	mV	
	V_{IL}	High/Low for All Inputs	-1810	—	-1475	mV	
Input Current	I_{IH}	$V_{in} = V_{IHA}$	—	—	220	μA	
	I_{IL}	$V_{in} = V_{ILB}$	CS	0.5	—	170	μA
			Others	-50	—	—	
Supply Current	I_{EE}	All Inputs and Outputs Open	-200	-165	—	mA	

● AC CHARACTERISTICS ($V_{EE} = -4.5V \pm 5\%$, $T_a = 0$ to $+85^\circ C$, air flow exceeding 2m/sec)

1. READ MODE

Item	Symbol	Test Condition	HM100474/F-15			HM100474/F			Unit
			min	typ	max	min	typ	max	
Chip Select Access Time	t_{ACS}		—	—	8	—	—	10	ns
Chip Select Recovery Time	t_{RCS}		—	—	8	—	—	10	ns
Address Access Time	t_{AA}		—	—	15	—	15	25	ns

2. WRITE MODE

Item	Symbol	Test Condition	HM100474/F-15			HM100474/F			Unit
			min	typ	max	min	typ	max	
Write Pulse Width	t_W	$t_{WSA} = 3ns$	15	—	—	25	15	—	ns
Data Setup Time	t_{WSD}		2	—	—	2	—	—	ns
Data Hold Time	t_{WHD}		2	—	—	2	—	—	ns
Address Setup Time	t_{WSA}		$t_W = t_{Wmin}$	3	—	—	3	—	—
Address Hold Time	t_{WHA}		2	—	—	2	—	—	ns
Chip Select Setup Time	$t_{W\hat{S}CS}$		2	—	—	2	—	—	ns
Chip Select Hold Time	t_{WHCS}		2	—	—	2	—	—	ns
Write Disable Time	t_{WS}		—	—	8	—	—	10	ns
Write Recovery Time	t_{WR}		—	—	8	—	—	10	ns

3. RISE/FALL TIME

Item	Symbol	Test Condition	min	typ	max	Unit
Output Rise Time	t_r		—	2	—	ns
Output Fall Time	t_f		—	2	—	ns

4. CAPACITANCE

Item	Symbol	Test Condition	min	typ	max	Unit
Input Capacitance	C_{in}		—	4	—	pF
Output Capacitance	C_{out}		—	7	—	pF

■ TEST CIRCUIT AND WAVEFORMS

1. LOADING CONDITION

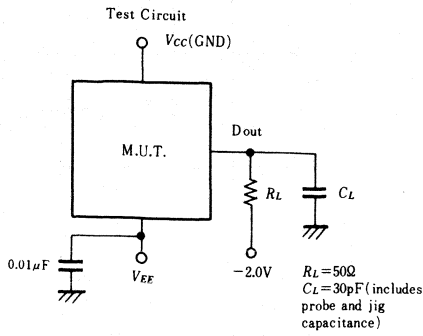

2. INPUT PULSE

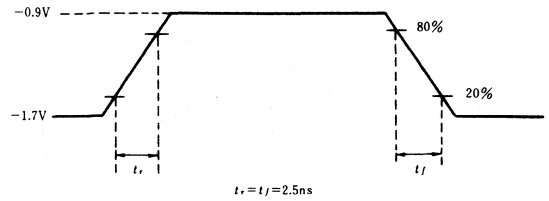

3. READ MODE

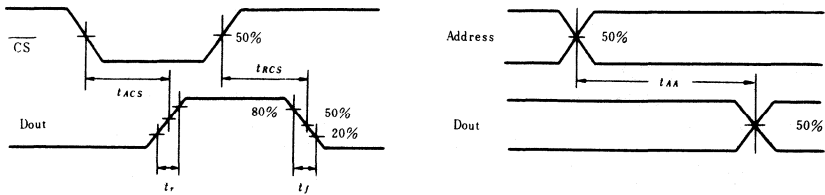

4. WRITE MODE

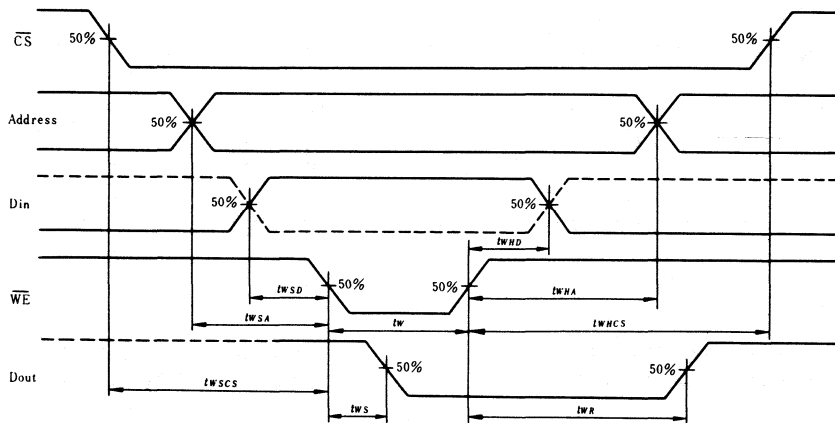

SUPPLY CURRENT vs. AMBIENT TEMPERATURE

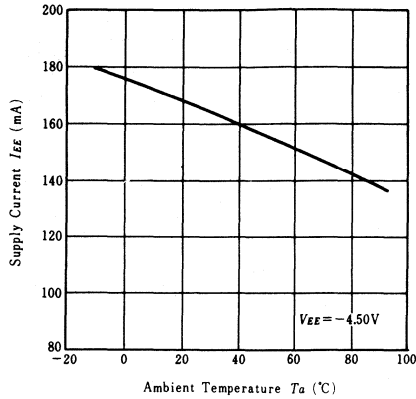

SUPPLY CURRENT vs. SUPPLY VOLTAGE

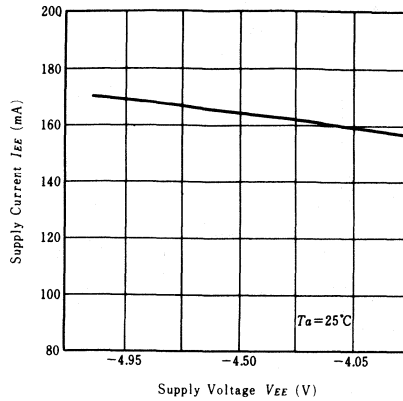

ADDRESS ACCESS TIME vs. AMBIENT TEMPERATURE

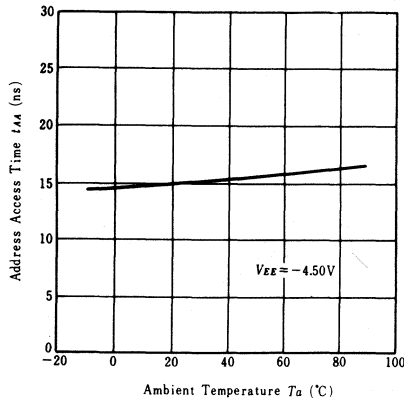

ADDRESS ACCESS TIME vs. SUPPLY VOLTAGE

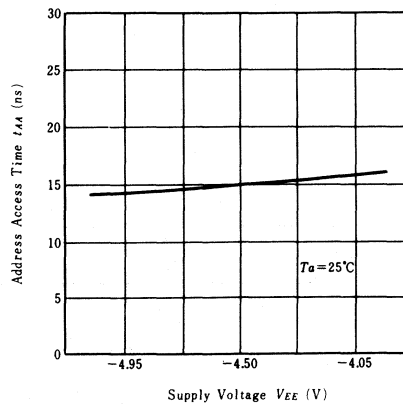

CHIP SELECT ACCESS TIME vs. AMBIENT TEMPERATURE

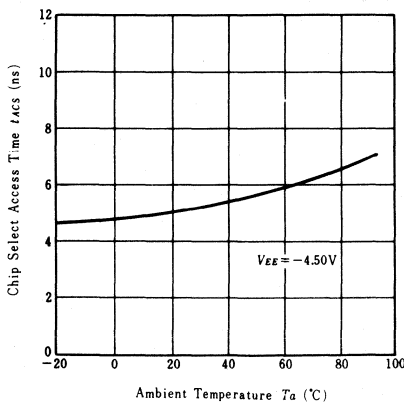

CHIP SELECT ACCESS TIME vs. SUPPLY VOLTAGE

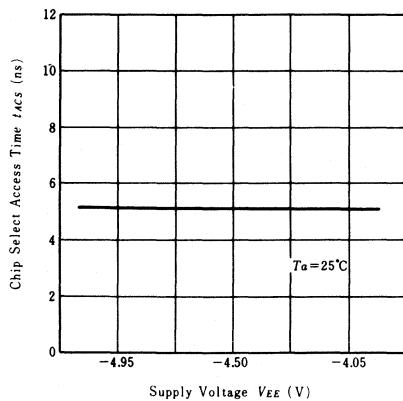

**WRITE PULSE WIDTH vs.
AMBIENT TEMPERATURE**

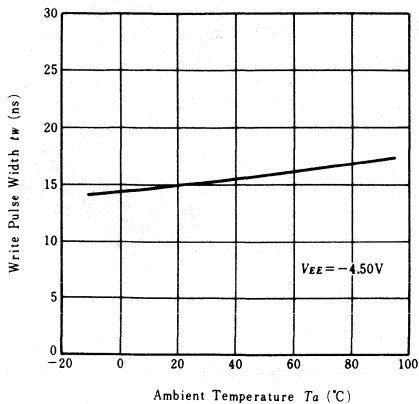

**WRITE PULSE WIDTH vs.
SUPPLY VOLTAGE**

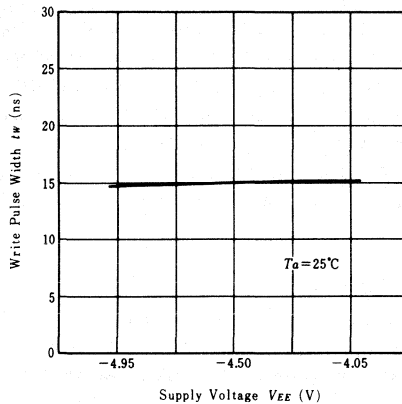

HM100480, HM100480F

16,384-words × 1-bit Fully Decoded Random Access Memory

The HM100480 is ECL 100K compatible, 16,384-words x 1-bit, read/write random access memory developed for high speed systems such as scratch pads and control/buffer storages.

The fabrication process uses the Hitachi's low capacitance, oxide isolation method with double metalization.

The HM100480 is encapsulated in cerdip-20 pin and flat-20 pin package, compatible with Fairchild's 100480.

FEATURES

- 16,384-words x 1-bit organization
- Fully compatible with 100K ECL level
- Address access time: 25ns (max)
- Write pulse width: 25ns (min)
- Low power dissipation: 0.05mW/bit
- Output obtainable by wired-OR (open emitter)

TRUTH TABLE

Input			Output	Mode
\overline{CS}	\overline{WE}	Din		
H	×	×	L	Not Selected
L	L	L	L	Write "0"
L	L	H	L	Write "1"
L	H	×	Dout*	Read

Notes) × : irrelevant
* : Read Out Noninvert

BLOCK DIAGRAM

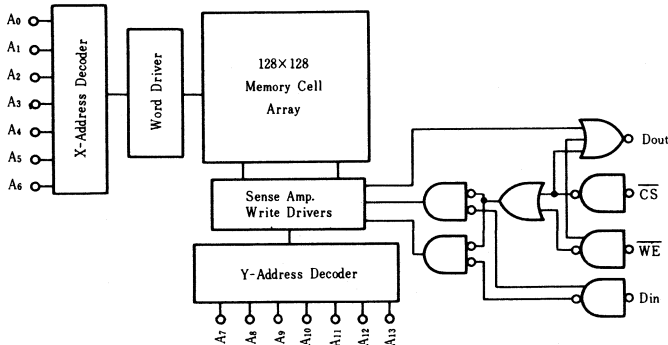

ABSOLUTE MAXIMUM RATINGS ($T_a=25^\circ\text{C}$)

Item	Symbol	Rating	Unit
Supply Voltage	V_{EE} to V_{CC}	+0.5 to -7.0	V
Input Voltage	V_{in}	+0.5 to V_{EE}	V
Output Current	I_{out}	-30	mA
Storage Temperature	T_{stg}	-65 to +150	$^\circ\text{C}$
Storage Temperature	$T_{stg}(\text{Bias})^*$	-55 to +125	$^\circ\text{C}$

* Under Bias

HM100480

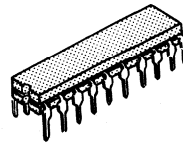

(DG-20)

HM100480F

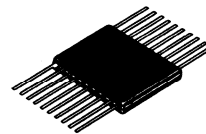

(FG-20)

PIN ARRANGEMENT

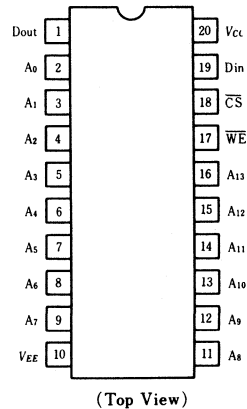

■ ABSOLUTE MAXIMUM RATINGS ($T_a=25^\circ\text{C}$)

Item	Symbol	Rating	Unit
Supply Voltage	V_{EE} to V_{CC}	+0.5 to -7.0	V
Input Voltage	V_{in}	+0.5 to V_{EE}	V
Output Current	I_{out}	-30	mA
Storage Temperature	T_{stg}	-65 to +150	$^\circ\text{C}$
Storage Temperature	$T_{stg}(\text{Bias})^*$	-55 to +125	$^\circ\text{C}$

* Under Bias

■ ELECTRICAL CHARACTERISTICS

● DC CHARACTERISTICS ($V_{EE}=-4.5\text{V}$, $R_L=50\Omega$ to -2.0V , $T_a=0$ to $+85^\circ\text{C}$, air flow exceeding 2m/sec)

Item	Symbol	Test Condition	min(B)	typ	max(A)	Unit	
Output Voltage	V_{OH}	$V_{in}=V_{IHA}$ or V_{ILB}	-1025	-955	-880	mV	
	V_{OL}		-1810	-1715	-1620	mV	
Output Threshold Voltage	V_{OHC}	$V_{in}=V_{IHB}$ or V_{ILA}	-1035	—	—	mV	
	V_{OLC}		—	—	-1610	mV	
Input Voltage	V_{IH}	Guaranteed Input Voltage	-1165	—	-880	mV	
	V_{IL}	High/Low for All Input	-1810	—	-1475	mV	
Input Current	I_{IH}	$V_{in}=V_{IHA}$	—	—	220	μA	
	I_{IL}	$V_{in}=V_{ILB}$	$\overline{\text{CS}}$	0.5	—	170	μA
			Others	-50	—	—	
Supply Current	I_{EE}	All Inputs and Outputs Open	-200	-165	—	mA	

● AC CHARACTERISTICS ($V_{EE}=-4.5\text{V}\pm 5\%$, $T_a=0$ to $+85^\circ\text{C}$, air flow exceeding 2m/sec)

1. READ MODE

Item	Symbol	Test Condition	min	typ	max	Unit
Chip Select Access Time	t_{ACS}		2	—	10	ns
Chip Select Recovery Time	t_{RCS}		2	—	10	ns
Address Access Time	t_{AA}		3	—	25	ns

2. WRITE MODE

Item	Symbol	Test Condition	min	typ	max	Unit
Write Pulse Width	t_w	$t_{WSA}=5\text{ns}$	25	—	—	ns
Data Setup Time	t_{WSD}		5	—	—	ns
Data Hold Time	t_{WHD}		5	—	—	ns
Address Setup Time	t_{WSA}		$t_w=t_w \text{ min}$	5	—	—
Address Hold Time	t_{WHA}		5	—	—	ns
Chip Select Setup Time	t_{WSCS}		5	—	—	ns
Chip Select Hold Time	t_{WHCS}		—	—	5	ns
Write Disable Time	t_{WS}		—	—	10	ns
Write Recovery Time	t_{WR}		—	—	10	ns

3. RISE/FALL TIME

Item	Symbol	Test Condition	min	typ	max	Unit
Output Rise Time	t_r		—	2	—	ns
Output Fall Time	t_f		—	2	—	ns

4. CAPACITANCE

Item	Symbol	Test Condition	min	typ	max	Unit
Input Capacitance	C_{in}		—	3	—	pF
Output Capacitance	C_{out}		—	5	—	pF

■ TEST CIRCUIT AND WAVEFORMS

1. LOADING CONDITION

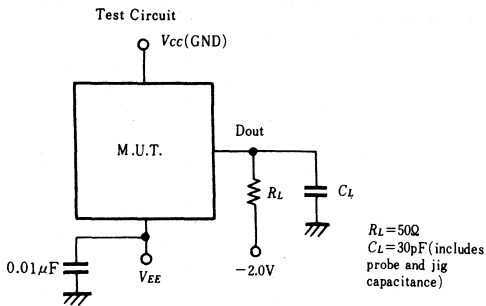

2. INPUT PULSE

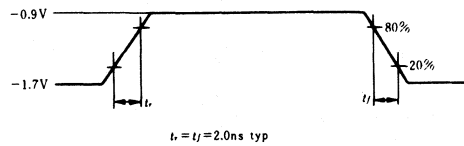

3. READ MODE

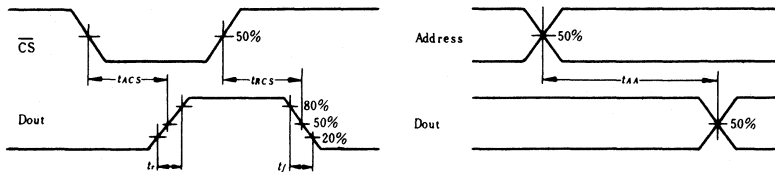

4. WRITE MODE

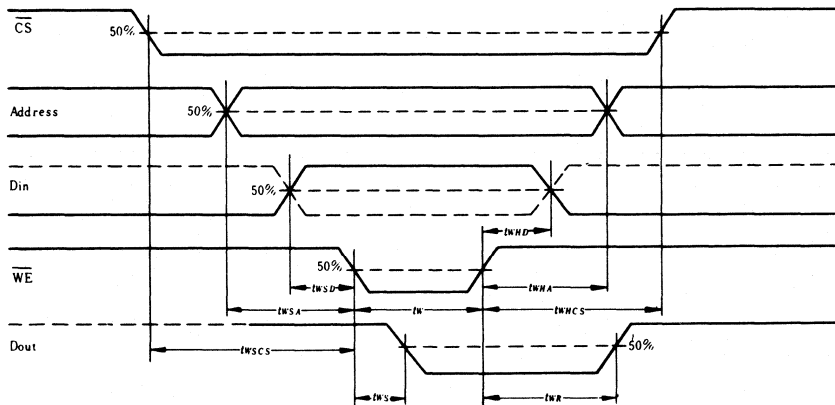

HM2504, HM2504-1

256-word × 1-bit Fully Decoded Random Access Memory

The HM2504 Series item is a TTL compatible, 256-word × 1-bit, read/write random access memory developed for application to buffer memories, control memories, high-speed main memories, etc. This is a fully decoded, read/write random access memory perfectly compatible with the TTL logic family, designed as an open collector output type for simplicity of expansion.

- Level TTL compatible
- Construction 256-word × 1 bit
- Read access time HM2504: 55ns (max)
HM2504-1: 45ns (max.)
- Chip select access time 30ns (max.)
- Power consumption 1.8mW/bit (typ)
- Output Open collector

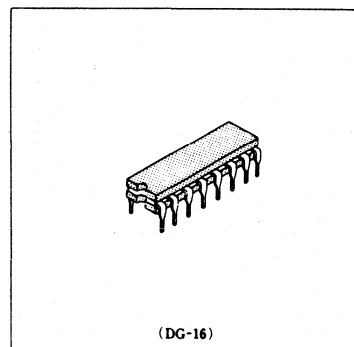

■ PIN ARRANGEMENT

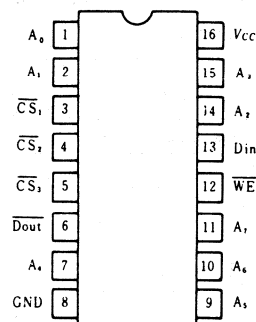

(Top View)

■ TRUTH TABLE

Inputs			Output Open Collector	Mode
CS	WE	Din		
any one H	×	×	H	Not Selected
all L	L	L	H	Write "0"
all L	L	H	H	Write "1"
all L	H	×	Dout*	Read

Notes) × : Don't care
* : Read out inverted

■ BLOCK DIAGRAM

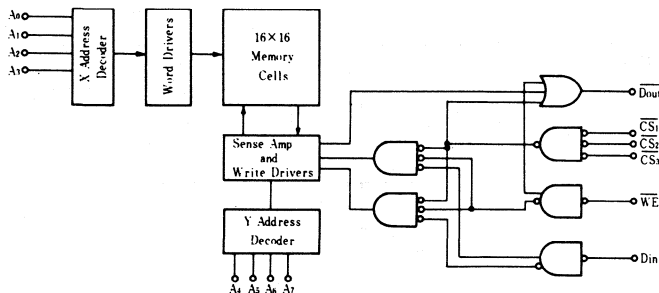

■ ABSOLUTE MAXIMUM RATINGS

Item	Symbol	HM2504, HM2504-1	Unit
Supply Voltage	V_{cc}	-0.5 to +7.0	V
Input Voltage	V_{in}	-0.5 to +5.5	V
Input Current	I_{in}	-12 to +5.0	mA
Output Voltage (Output High)	V_{out}	-0.5 to +5.5	V
Output Voltage (DC Output Low)	I_{out}	+20	mA
Storage Temperature	T_{stg}	-65 to +150	°C
Storage Temperature	$T_{stg}(\text{Bias})^*$	-55 to +125	°C

* Under Bias

■ ELECTRICAL CHARACTERISTICS

● DC CHARACTERISTICS ($V_{CC}=5.0V \pm 5\%$, $T_a=0$ to $+75^\circ\text{C}$, air flow exceeding 2m/sec)

Item	Symbol	Test Condition	HM2504 Series			Unit
			min	typ	max	
Output Voltage	V_{OL}	$V_{CC}=4.75V$, $I_{OL}=16\text{mA}$	—	0.3	0.45	V
Input Voltage	V_{IH}	Guaranteed Input Voltage High	2.0	1.6	—	V
	V_{IL}	Guaranteed Input Voltage Low	—	1.5	0.85	V
Input Current	I_{IH}	$V_{CC}=5.25V$, $V_{in}=4.5V$	—	0	20	μA
	I_{IL}	$V_{CC}=5.25V$, $V_{in}=0$	—	-530	-800	μA
Output Leakage Current	I_{CEX}	$V_{CC}=5.25V$, $V_{out}=4.5V$	—	0	50	μA
Input Clamp Voltage	V_i	$V_{CC}=5.25V$, $I_{in}=-10\text{mA}$	—	-1.0	-1.5	V
Supply Current	I_{CC}	$V_{CC}=5.25V$	$0 < T_a < 25^\circ\text{C}$		135	mA
		All input GND	$T_a \geq 25^\circ\text{C}$		130	mA

● AC CHARACTERISTICS

($V_{CC}=5.0V \pm 5\%$, $T_a=0$ to $+75^\circ\text{C}$, air flow exceeding 2m/s, see test circuit and waveforms)

1. READ MODE

Item	Symbol	Test Condition	HM2504			HM2504-1			Unit
			min	typ	max	min	typ	max	
Chip Select Access Time	t_{ACS}		—	12	30	—	12	30	ns
Chip Select Recovery Time	t_{RCS}		—	18	25	—	18	25	ns
Address Access Time	t_{AA}		—	35	55	—	30	45	ns

2. WRITE MODE

Item	Symbol	Test Condition	HM2504			HM2504-1			Unit
			min	typ	max	min	typ	max	
Write Pulse Width	t_w	$t_{WSA}=0\text{ns}$	30	8	—	30	8	—	ns
Data Setup Time	t_{WSD}		0	0	—	0	0	—	ns
Data Hold Time	t_{WHD}		5	0	—	5	0	—	ns
Address Setup Time	t_{WSA}	$t_w=30\text{ns}$	0	0	—	0	0	—	ns
Address Hold Time	t_{WHA}		5	0	—	5	0	—	ns
Chip Select Setup Time	t_{WSCS}		0	0	—	0	0	—	ns
Chip Select Hold Time	t_{WHCS}		5	0	—	5	0	—	ns
Write Disable Time	t_{WS}		—	14	35	—	14	35	ns
Write Recovery Time	t_{WR}		—	12	40	—	12	40	ns

3. CAPACITANCE

Item	Symbol	Test Condition	HM2504			HM2504-1			Unit
			min	typ	max	min	typ	max	
Input Capacitance	C_{in}		—	3	5	—	3	5	pF
Output Capacitance	C_{out}		—	6	8	—	6	8	pF

TEST CIRCUIT AND WAVEFORMS

1. LOADING CONDITION

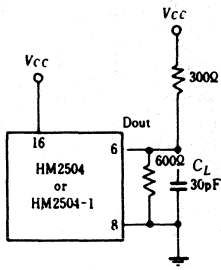

Note: C_L includes jig and stray capacitance

2. INPUT PULSE

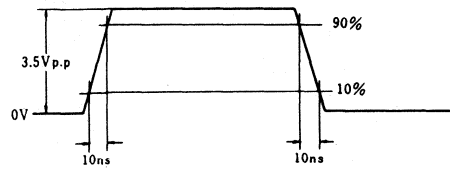

3. READ MODE

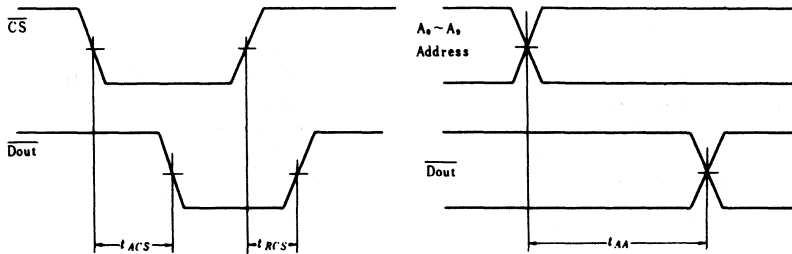

(All time measurements refer to 1.5V)

4. WRITE MODE

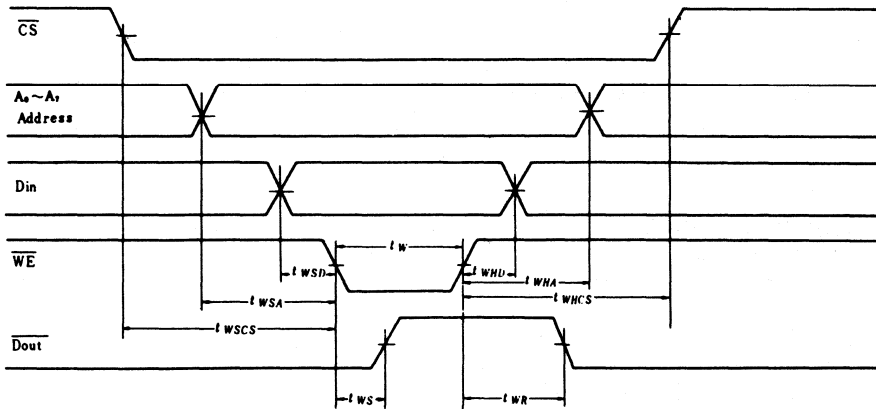

(All time measurements refer to 1.5V)

INPUT CHARACTERISTICS

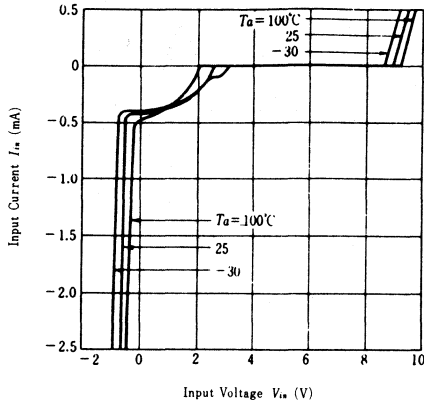

OUTPUT CHARACTERISTICS

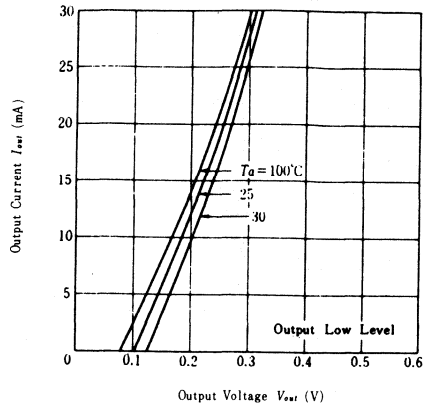

SUPPLY CURRENT vs. AMBIENT TEMPERATURE

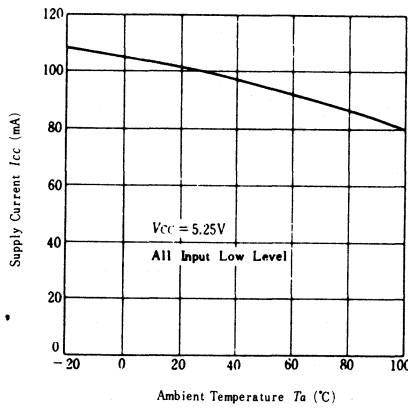

ADDRESS ACCESS TIME vs. AMBIENT TEMPERATURE

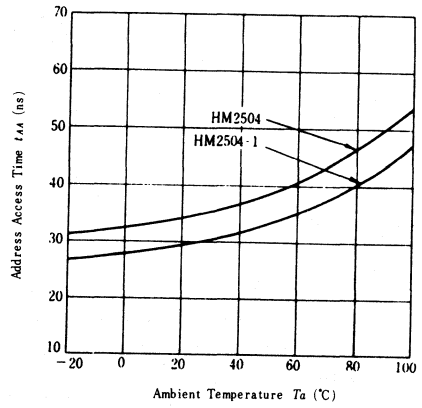

SUPPLY CURRENT vs. SUPPLY VOLTAGE

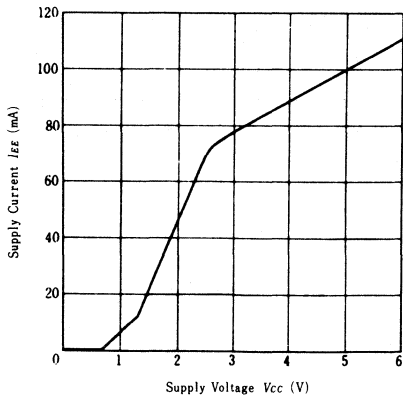

HM2510, HM2510-1, HM2510-2

1024-word × 1-bit Fully Decoded Random Access Memory

The HM2510 Series item is a 1024-word × 1-bit read/write random access memory developed for application to buffer memories, control memories, high-speed main memories, etc. It is a fully decoded, read write, random access memory perfectly compatible with TTL logic families, designed as an open collector output type for simplicity of expansion.

- Level TTL compatible
- Construction 1024-word × 1 bit
- Read access time HM2510: 70ns (max.)
HM2510-1: 45ns (max.)
HM2510-2: 35ns (max.)
- Chip select access time HM2510: 40ns (max.)
HM2510-1: 30ns (max.)
HM2510-2: 25ns (max.)
- Power consumption 0.5mW/bit
- Output Open collector

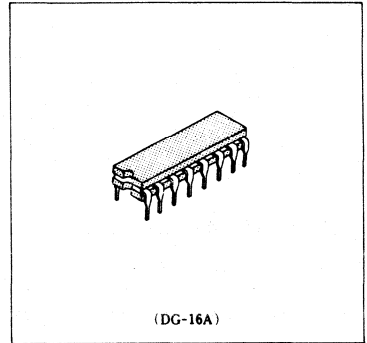

TRUTH TABLE

Inputs			Output	Mode
\overline{CS}	\overline{WE}	Din		
H	×	×	H	Not Selected
L	L	L	H	Write "0"
L	L	H	H	Write "1"
L	H	×	Dout*	Read

Notes) × : Don't care
* : Read out non-inverted

PIN ARRANGEMENT

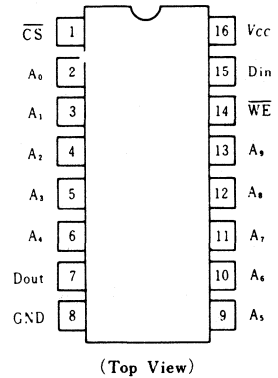

BLOCK DIAGRAM

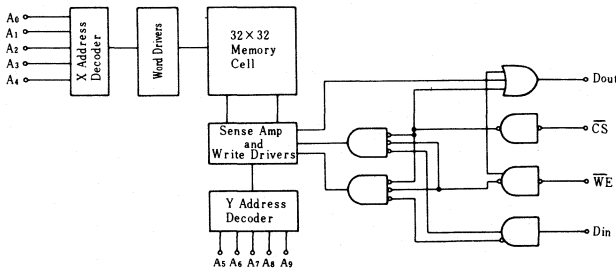

■ ABSOLUTE MAXIMUM RATINGS

Item	Symbol	HM2510 Series	Unit
Supply Voltage	V_{CC}	-0.5 to +7.0	V
Input Voltage	V_{in}	-0.5 to +5.5	V
Input Current	I_{in}	-12 to +5.0	mA
Output Voltage (Output High)	V_{out}	-0.5 to +5.5	V
Output Voltage (DC Output Low)	I_{out}	+20	mA
Storage Temperature	T_{stg}	-65 to +150	°C
Storage Temperature	$T_{stg}(\text{Bias})^*$	-55 to +125	°C

* Under Bias

■ ELECTRICAL CHARACTERISTICS

● DC CHARACTERISTICS ($V_{CC}=5.0V \pm 5\%$, $T_a=0$ to $+75^\circ\text{C}$, air flow exceeding 2m/sec)

Item	Symbol	Test Condition	HM2510 Series			Unit	
			min	typ	max		
Output Voltage	V_{OL}	$V_{CC}=4.75V$, $I_{OL}=16\text{mA}$	—	0.3	0.45	V	
Input Voltage	V_{IH}	Guaranteed Input Voltage High	2.1	1.6	—	V	
	V_{IL}	Guaranteed Input Voltage Low	—	1.5	0.80	V	
Input Current	I_{IH1}	$V_{CC}=5.25V$, $V_{in}=4.5V$	—	0	40	μA	
	I_{IH2}	$V_{CC}=5.25V$, $V_{in}=5.25V$	—	0	1.0	mA	
	I_{IL}	$V_{CC}=5.25V$, $V_{in}=0.4V$	—	-250	-400	μA	
Output Leakage Current	I_{CEX}	$V_{CC}=5.25V$, $V_{out}=4.5V$	—	0	100	μA	
Input Clamp Voltage	V_I	$V_{CC}=5.25V$, $I_{in}=-10\text{mA}$	—	-1.1	-1.5	V	
Supply Current	I_{CC}	$V_{CC}=5.25V$	$0 < T_a < 25^\circ\text{C}$	—	—	155	mA
		All input GND	$T_a \geq 25^\circ\text{C}$	—	95	130	mA

● AC CHARACTERISTICS ($V_{CC}=5.0V \pm 5\%$, $T_a=0$ to $+75^\circ\text{C}$, air flow exceeding 2m/sec)

1. READ MODE

Item	Symbol	Test Condition	HM2510			HM2510-1			HM2510-2			Unit
			min	typ	max	min	typ	max	min	typ	max	
Chip Select Access Time	t_{ACS}		—	15	40	—	—	30	—	15	25	ns
Chip Select Recovery Time	t_{RCS}		—	25	40	—	—	30	—	17	25	ns
Address Access Time	t_{AA}		—	40	70	—	35	45	—	25	35	ns

2. WRITE MODE

Item	Symbol	Test Condition	HM2510			HM2510-1			HM2510-2			Unit
			min	typ	max	min	typ	max	min	typ	max	
Write Pulse Width	t_w	$t_{WSA}=\text{min}$	50	10	—	35	10	—	25	10	—	ns
Data Setup Time	t_{WSD}		5	0	—	5	—	—	5	0	—	ns
Data Hold Time	t_{WHD}		5	0	—	5	—	—	5	0	—	ns
Address Setup Time	t_{WSA}		$t_w=\text{min}$	15	0	—	5	—	—	5	0	—
Address Hold Time	t_{WHA}		5	0	—	5	—	—	5	0	—	ns
Chip Select Setup Time	t_{WSCS}		5	0	—	5	—	—	5	0	—	ns
Chip Select Hold Time	t_{WHCS}		5	0	—	5	—	—	5	0	—	ns
Write Disable Time	t_{WSD}		—	20	40	—	20	35	—	15	25	ns
Write Recovery Time	t_{WR}		—	30	55	—	30	45	—	15	25	ns

3. CAPACITANCE

Item	Symbol	Test Condition	HM2510 Series			Unit
			min	typ	max	
Input Capacitance	C_{in}		—	3	5	pF
Output Capacitance	C_{out}		—	6	8	pF

■ TEST CIRCUIT AND WAVEFORMS

1. LOADING CONDITION

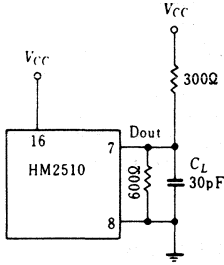

2. INPUT PULSE

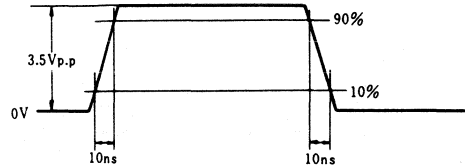

3. READ MODE

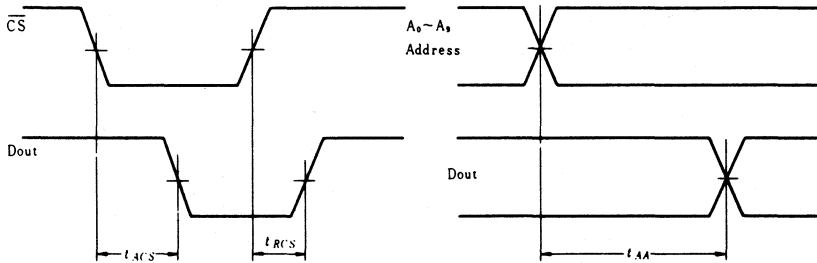

(All time measurements refer to 1.5V)

4. WRITE MODE

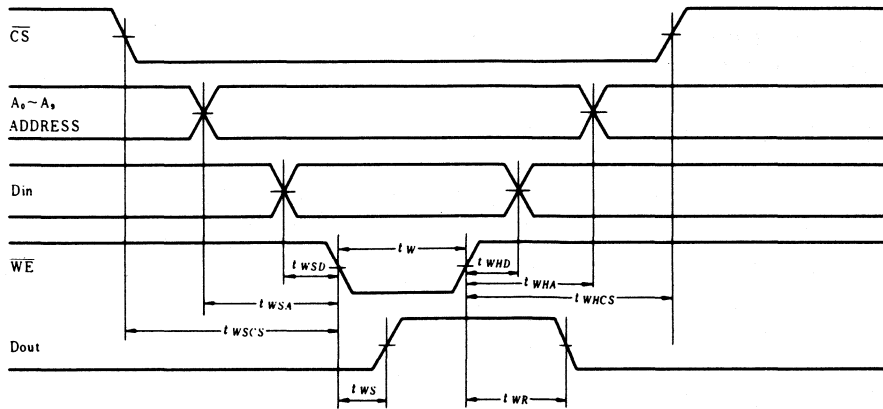

(All time measurements refer to 1.5V)

INPUT CHARACTERISTICS

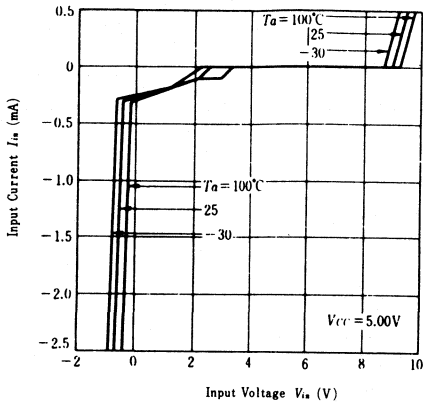

OUTPUT CHARACTERISTICS

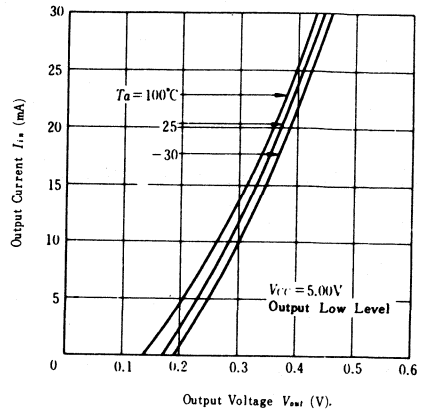

SUPPLY CURRENT vs. AMBIENT TEMPERATURE

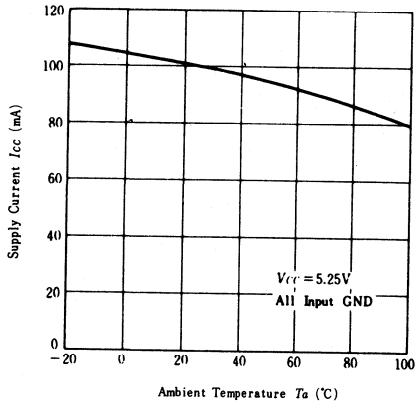

ADDRESS ACCESS TIME vs. AMBIENT TEMPERATURE

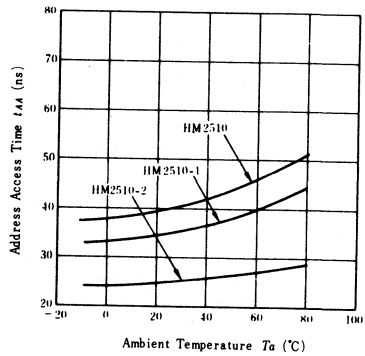

SUPPLY CURRENT vs. SUPPLY VOLTAGE

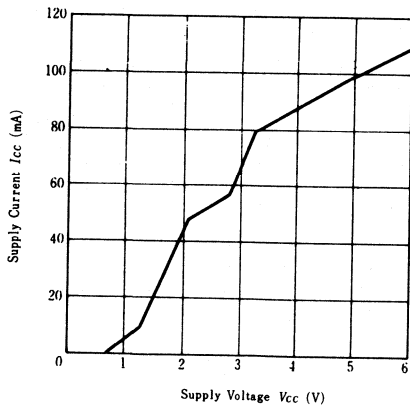

HM2511, HM2511-1

1024-word × 1-bit Fully Decoded Random Access Memory

The HM2511 Series item is a 1024-word x 1-bit read/write random access memory with three-state output developed for application to buffer memories, control memories, high-speed main memories, etc. It is a fully decoded, read/write, random access memory perfectly compatible with TTL logic families.

- Level TTL compatible
- Construction 1024-word x 1 bit
- Read access time HM2511: 70ns (max)
HM2511-1: 45ns (max)
- Chip select access time HM2511: 40ns (max)
HM2511-1: 30ns (max)
- Power consumption 0.5mW/bit
- Output three-state

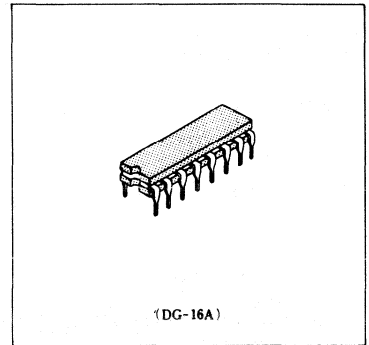

TRUTH TABLE

Input			Output	Mode
\overline{CS}	\overline{WE}	Din		
H	×	×	High Z	Not Selected
L	L	L	High Z	Write "0"
L	L	H	High Z	Write "1"
L	H	×	Dout*	Read

Notes) × : Don't care
* : Read out noninverted

BLOCK DIAGRAM

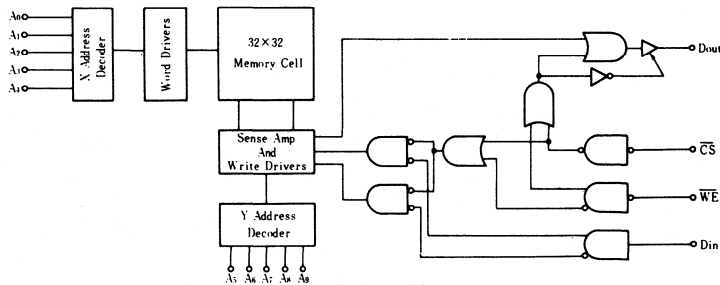

PIN ARRANGEMENT

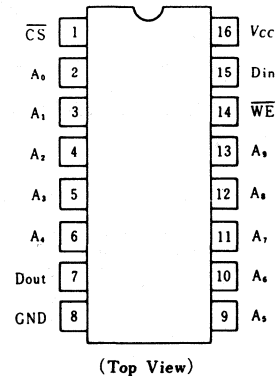

(Top View)

ABSOLUTE MAXIMUM RATINGS

Item	Symbol	HM2511 Series	Unit
Supply Voltage	V_{CC}	-0.5 to +7.0	V
Input Voltage	V_{in}	-0.5 to +5.5	V
Input Current	I_{in}	-12 to +5.0	mA
Output Voltage (Output High)	V_{out}	-0.5 to +5.5	V
Output Voltage (DC Output Low)	I_{out}	+20	mA
Storage Temperature	T_{stg}	-65 to +150	°C
Storage Temperature	$T_{stg}(\text{Bias})^*$	-55 to +125	°C

* Under Bias

■ ELECTRICAL CHARACTERISTICS

● DC CHARACTERISTICS ($V_{CC}=5.0V \pm 5\%$, $T_a=0$ to $+75^\circ C$, air flow exceeding 2m/sec)

Item	Symbol	Test Condition	HM2511 Series			Unit	
			min	typ	max		
Output Low Voltage	V_{OL}	$V_{CC}=4.75V, I_{OL}=16mA$	—	0.3	0.45	V	
Input Voltage	V_{IH}	Guaranteed Input Voltage High	2.1	1.6	—	V	
	V_{IL}	Guaranteed Input Voltage Low	—	1.5	0.8	V	
Input Current	I_{IH1}	$V_{CC}=5.25V, V_{in}=4.5V$	—	0	40	μA	
	I_{IH2}	$V_{CC}=5.25V, V_{in}=5.25V$	—	0	1.0	mA	
	I_{IL}	$V_{CC}=5.25V, V_{in}=0.4V$	—	-250	-400	μA	
Output Current (High Z)	I_{OFF1}	$V_{CC}=5.25V, V_{out}=2.4V$	—	—	50	μA	
	I_{OFF2}	$V_{CC}=5.25V, V_{out}=0.5V$	—	—	-50	μA	
Output Current Short Circuit to Ground	I_{OS}	$V_{CC}=5.25V,$	—	—	-100	mA	
Output High Voltage	V_{OH}	$I_{OH}=-10.3mA, V_{CC}=5.0V \pm 5\%$	2.4	—	—	V	
Input Clamp Voltage	V_I	$V_{CC}=5.25V, I_{in}=-10mA$	—	-1.0	-1.5	V	
Supply Current	I_{CC}	$V_{CC}=5.25V$ All input GND	$0 \leq T_a < 25^\circ C$	—	—	155	mA
			$T_a \geq 25^\circ C$	—	95	130	mA

● AC CHARACTERISTICS ($V_{CC}=5.0V \pm 5\%$, $T_a=0$ to $+75^\circ C$, air flow exceeding 2m/sec)

1. READ MODE

Item	Symbol	Test Condition	HM2511			HM2511-1			Unit
			min	typ	max	min	typ	max	
Chip Select Access Time	t_{ACS}		—	15	40	—	—	30	ns
Chip Select to High Z	t_{ZRCs}		—	20	40	—	—	30	ns
Address Access Time	t_{AA}		—	40	70	—	35	45	ns

2. WRITE MODE

Item	Symbol	Test Condition	HM2511			HM2511-1			Unit
			min	typ	max	min	typ	max	
Write Pulse Width	t_w	$t_{WSA}=\text{min}$	50	25	—	35	10	—	ns
Data Setup Time	t_{WSD}		5	0	—	5	—	—	ns
Data Hold Time	t_{WHD}		5	0	—	5	—	—	ns
Address Setup Time	t_{WSA}	$t_w=\text{min}$	15	0	—	5	—	—	ns
Address Hold Time	t_{WHA}		5	0	—	5	—	—	ns
Chip Select Setup Time	t_{WScs}		5	0	—	5	—	—	ns
Chip Select Hold Time	t_{WHCS}		5	0	—	5	—	—	ns
Write Disable to High Z	t_{ZWS}		—	20	40	—	20	35	ns
Write Recovery Time	t_{WR}		—	42	55	—	30	45	ns

3. CAPACITANCE

Item	Symbol	Test Condition	HM2511 Series			Unit
			min	typ	max	
Input Capacitance	C_{in}		—	3	5	pF
Output Capacitance	C_{out}		—	9	11	pF

■ TEST CIRCUIT AND WAVEFORMS

1. LOADING CONDITION

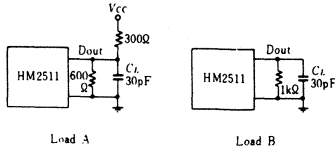

2. INPUT PULSE

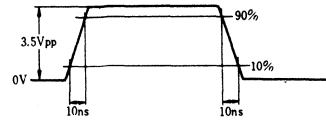

3. READ MODE

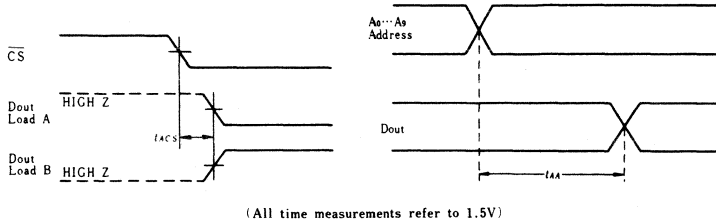

4. WRITE MODE

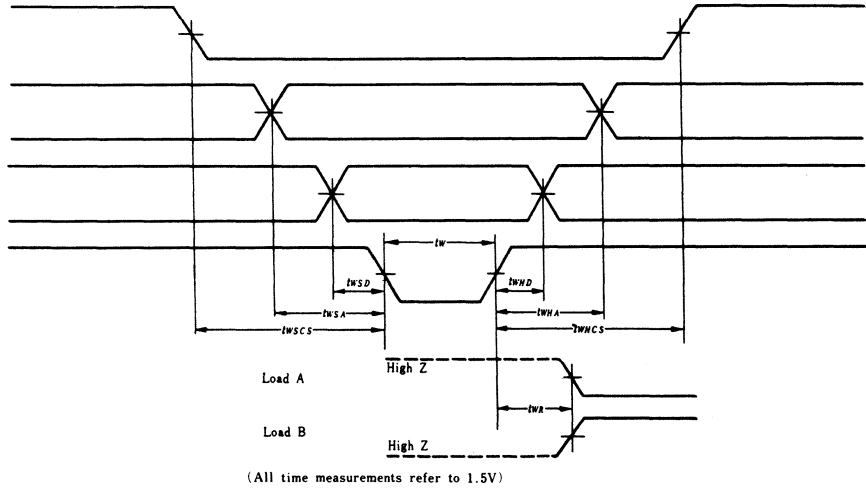

5. WRITE ENABLE TO HIGH Z DELAY

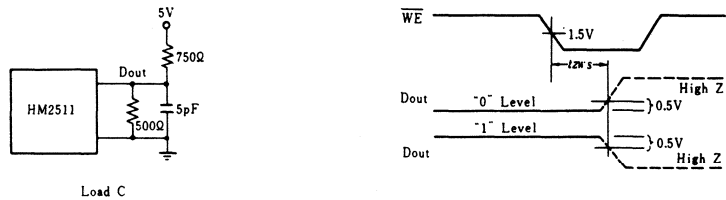

6. PROPAGATION DELAY FROM CHIP SELECT TO HIGH Z

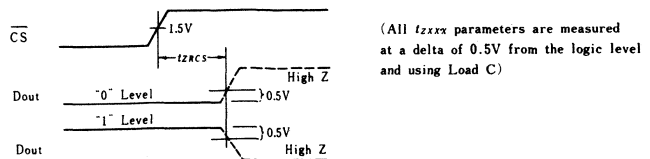

BIPOLAR PROM

PROGRAMMING INFORMATION

Hitachi's sophisticated Fine Emitter technology and programming pulse method enables higher programmability and faster programming time ordinary PROMs, for the highest reliability.

Fast programming time of typically $7.5\mu\text{s}/\text{bit}$ is achieved with a fine emitter cell which requires less programming energy; thus, negligible thermal stress. Further, Hitachi advanced technology allows very high programmability.

To assure that the element is programmed properly an additional four programming pulses are applied immediately after a sense pulse indicates conduction in the programmed (one programming pulse: Series) bit. This high reliability feature virtually eliminates aluminum migration in the programmed cell.

One extra row and one extra column of test cells, plus additional circuitry built into the PROM chip, allow improved factory testing of DC, AC and programming characteristics. These test cells and test circuitry provide enhanced correlation between programmed and unprogrammed circuits in order to guarantee high programmability and reliability.

PROGRAMMED CELL (CROSS SECTION)

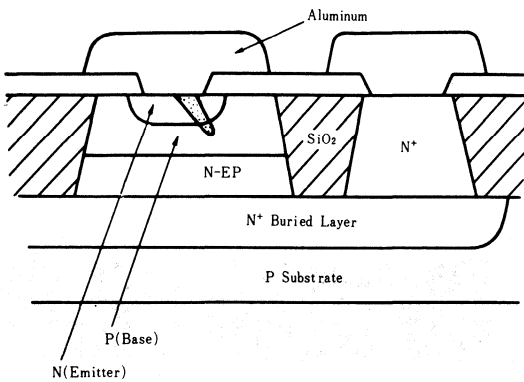

The device is manufactured with outputs low (positive logic "zero") in all storage cells. To make an output high at a particular cell, a junction must be changed from a blocking state to a conducting state. This procedure is called programming.

A logic "one" can be permanently programmed into a selected bit location. The desired bit for programming is selected using ten address inputs to turn on transistors Q1 and Q2. By taking either (or both) chip enable inputs high, the chip is disabled and transistor Q3 is held off. Then, a train of programming pulses applied to the desired output flows through the junction into transistor Q1. This programming current changes the junction to the conducting state. The pulse train is stopped as soon as the sensed voltage indicates that the selected bit is in the logic in state.

An additional 4 programming pulses (1 programming pulse: S-series) are required to ensure that the bit is fully programmed, and to achieve high reliability. One output must be programmed at a time, since the internal decoding circuit is capable of sinking only one unit of programming current at time.

INTERNAL PROGRAMMING CIRCUIT

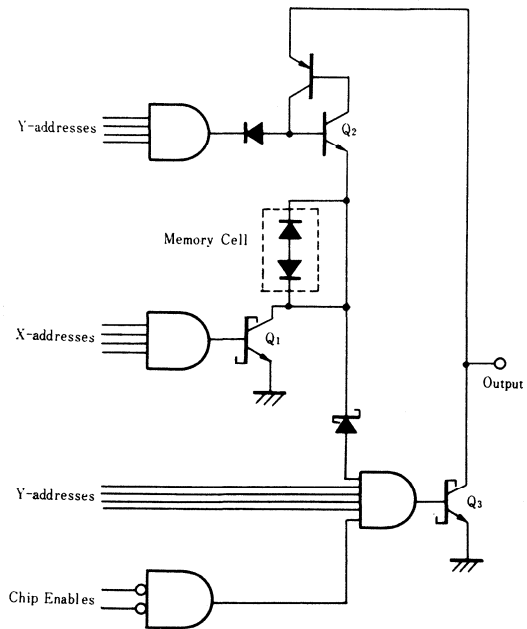

■ HITACHI PROMS AND PROGRAMMING CURRENT

Memory Size	Organization	Output	N-Series	S-Series
4k	1k×4	O.C.	HN25044 (50ns max)	—
		3 S	HN25045 (50ns max)	—
8k	2k×4	O.C.	HN25084 (60ns max)	HN25084S(50ns max)
		3 S	HN25085 (60ns max)	HN25085S(50ns max)
	1k×8	O.C.	HN25088 (60ns max) HN25088L(100ns max)	HN25088S(50ns max)
		3 S	HN25089 (60ns max) HN25089L(100ns max)	HN25089S(50ns max)
16k	2k×8	O.C.	—	HN25168S(60ns max)
		3 S	—	HN25169S(60ns max)
Programming Current			130mA(typ)	90mA(typ)

Note) O.C. : Open Collector Output
3 S : Three State Output

Hitachi's PROM has two families in accordance with the program specifications. They are usually discriminated by the suffix of the model name. For the S-series PROM, the production technique established for the N-series PROM is further improved to attain very small memory cell area and chip area as well as high performance.

HN25044, HN25045

1024-word × 4-bit Programmable Read Only Memory

The HITACHI HN25044 and HN25045 are high speed electrically programmable, fully decoded TTL Bipolar 4096 bit read only memories organized at 1024 words by 4 bits with on-chip address decoding and two chip enable inputs. The HN25044 and HN25045 are fabricated with logic level "zeros" (low); logic level "ones" (high) can be electrically programmed in the selected bit locations. The same address inputs are used for both programming and reading.

■ FEATURES

- 1024 words x 4 bits organization (fully decoded)
- TTL Compatible inputs and outputs
- Fast read access time; 30 ns typ. (50 ns max.)
- Medium power consumption; 500 mW typ.
- Two Chip enable inputs for memory expansion
- Open collector outputs (HN25044)/Three-state outputs (HN25045)
- Standard cerdip 18-pin package

■ BLOCK DIAGRAM

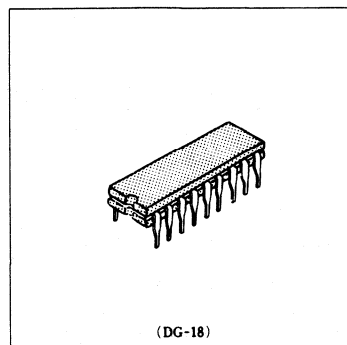
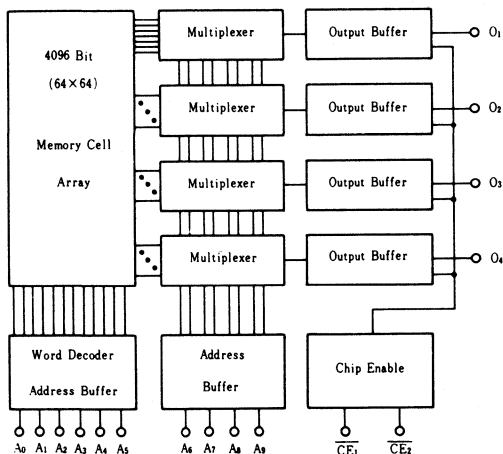

■ PIN ARRANGEMENT

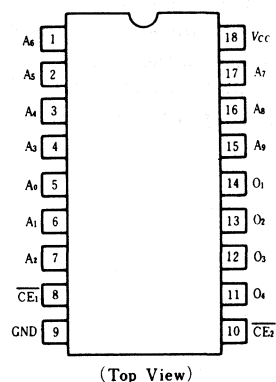

■ ABSOLUTE MAXIMUM RATINGS ($T_a = 25^\circ\text{C}$)

Item	Symbol	Rating	Unit
Supply Voltage	V_{CC}	-0.5 to +7.0	V
Input Voltage	V_{in}	-0.5 to +5.5	V
Output Voltage	V_{out}	-0.5 to +5.5	V
Output Current	I_{out}	50	mA
Operating Temperature	T_{opr}	-25 to +75	$^\circ\text{C}$
Storage Temperature	T_{stg}	-65 to +150	$^\circ\text{C}$

■ DC CHARACTERISTICS ($V_{CC}=4.75$ to $5.25V$, $T_a=0$ to $+75^{\circ}C$)

Item	Symbol	Test Condition	HN25044			HN25045			Unit
			min	typ	max	min	typ	max	
Input Voltage	V_{IH}		2.0	—	—	2.0	—	—	V
	V_{IL}		—	—	0.8	—	—	0.8	V
Output Voltage	V_{OH}	$I_{OH} = -2mA$	—	—	—	2.4	—	—	V
	V_{OL}	$I_{OL} = 16mA$	—	—	0.45	—	—	0.45	V
Input Current	I_{IH}	$V_{IH} = 2.7V$	—	—	40	—	—	40	μA
	I_{IL}	$V_{IL} = 0.4V$	—	—	-0.4	—	—	-0.4	mA
Output Leakage Current	I_{OLK}	$V_{out} = 5.5V$	—	—	100	—	—	100	μA
		$V_{out} = 0.4V$	—	—	40	—	—	40	
Input Clamp Voltage	V_i	$I_{in} = -18mA$	—	—	-1.2	—	—	-1.2	V
Power Supply Current	I_{CC}	Input Either Open or at Ground	—	100	130	—	100	130	mA
Output Short-circuit Current	I_{OS}	$V_{out} = 0V$	—	—	—	15	30	60	mA
Input Capacitance	C_{in}	$V_{in} = 2V$, $V_{CC} = 0V$	—	5	10	—	5	10	pF
Output Capacitance	C_{out}	$V_{out} = 0V$, $V_{CC} = 0V$	—	7	12	—	7	12	pF

■ AC CHARACTERISTICS ($V_{CC}=4.75$ to $5.25V$, $T_a=0$ to $75^{\circ}C$)

Item	Symbol	min	typ	max	Unit
Address Access Time	t_{AA}	—	35	50	ns
Chip Enable Access Time	t_{ACE}	—	20	30	ns
Chip Enable Disable Time	t_{DCE}	—	20	30	ns

Notes: 1. Typ. value is at $V_{CC}=5.0V$ and $T_a = 25^{\circ}C$

2. Output disable time is the time taken for the output to reach a high resistance state when either chip enable is taken high. Output enable time is the time taken for the output to become active when both chip enables are taken low. The high resistance state is defined as a point on the output waveform equal to a ΔV of 0.5 V from the active output level.

■ SWITCHING WAVEFORMS

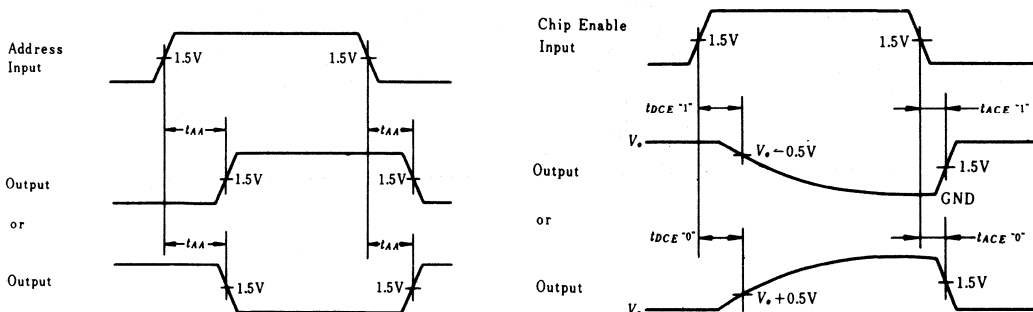

■ SWITCHING TIME TEST CONDITIONS

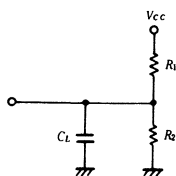

SWITCHING PARAMETER	HN25044			HN25045		
	R_1	R_2	C_L	R_1	R_2	C_L
t_{AA}	300 Ω	600 Ω	30pF	300 Ω	600 Ω	30pF
t_{ACE} "1"	—	—	—	∞	600 Ω	10pF
t_{ACE} "0"	300 Ω	600 Ω	10pF	300 Ω	600 Ω	10pF
t_{DCE} "1"	—	—	—	∞	600 Ω	30pF
t_{DCE} "0"	300 Ω	600 Ω	30pF	300 Ω	600 Ω	30pF

INPUT CONDITIONS
 Amplitude - 0V to 3V
 Rise and Fall time - 5ns from 1V to 2V
 Frequency - 1MHz

■ PROGRAMMING SPECIFICATION

Characteristic	Limit	Unit	Notes
Ambient Temperature	25±5	°C	
Programming Pulse			
Amplitude	130±5%	mA	10V point/150Ω load
Clamp Voltage	20+0%−2%	V	
Ramp Rate	70max	V/μs	
Pulse Width	7.5±5%	μs	
Duty Cycle	70% min		
Sense Current			
Amplitude	20±0.5	mA	10V point/150Ω load
Clamp Voltage	20+0%−2%	V	
Ramp Rate	70max	V/μs	
Sense current interruption before and after address change	10min	μs	
Programming V _{cc}	5.0+5%−0%	V	
Maximum Sensed Voltage for programmed "1"	7.5±0.1	V	
Delay from trailing edge of programming pulse before sensing output voltage	0.7min	μs	
Programming Time Allocation/Bit	100max	ms	
Additional Programming Pulse Number	4	Time	

■ TYPICAL WAVEFORMS

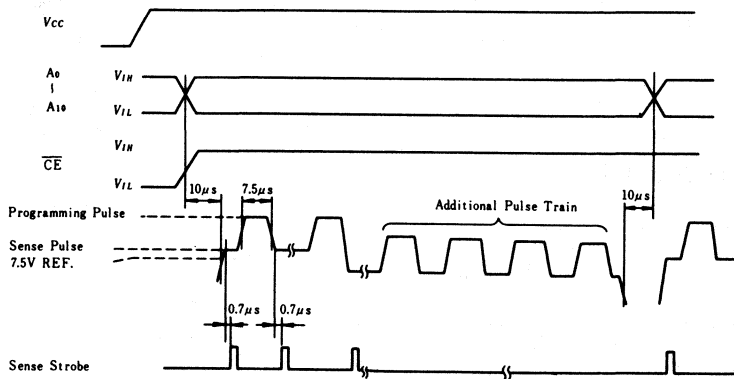

TYPICAL DC CHARACTERISTICS

INPUT CURRENT vs. INPUT VOLTAGE

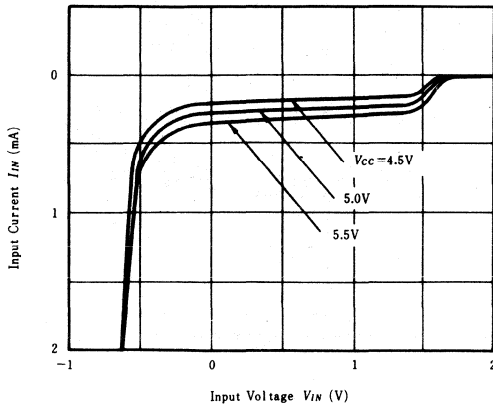

OUTPUT LOW CURRENT vs. OUTPUT LOW VOLTAGE

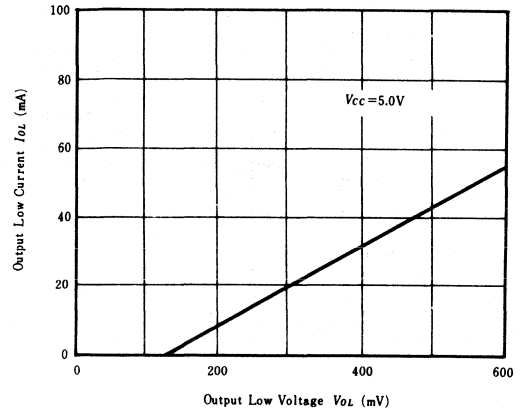

OUTPUT HIGH CURRENT vs. OUTPUT HIGH VOLTAGE (HN25045)

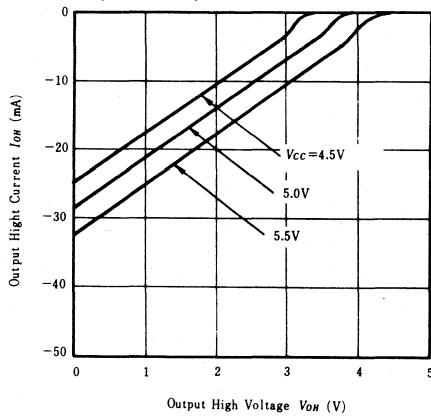

TYPICAL AC CHARACTERISTICS

ACCESS TIME vs. AMBIENT TEMPERATURE (HN25044)

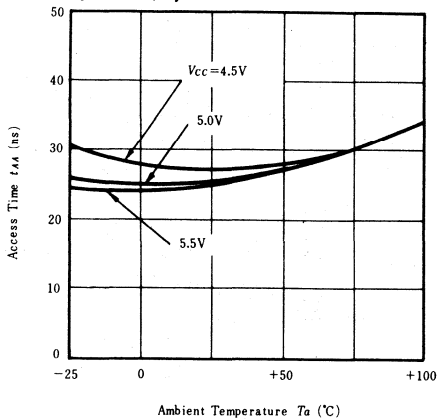

ACCESS TIME vs. AMBIENT TEMPERATURE (HN25045)

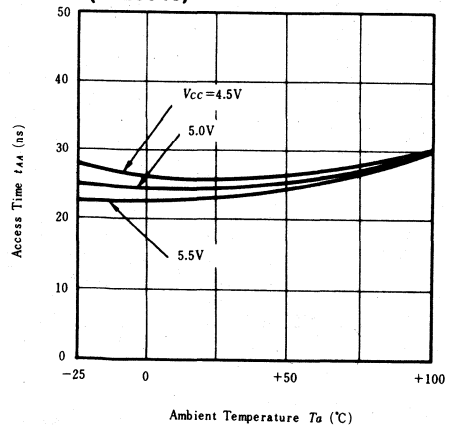

**DISABLE TIME vs.
AMBIENT TEMPERATURE
(HN25044)**

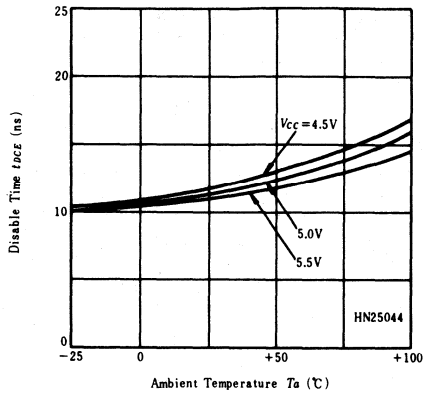

**DISABLE TIME vs.
AMBIENT TEMPERATURE
(HN25045)**

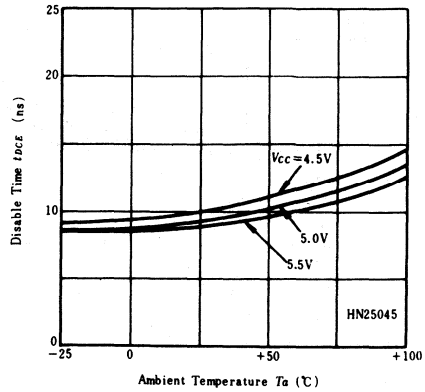

**ENABLE TIME vs.
AMBIENT TEMPERATURE
(HN25044)**

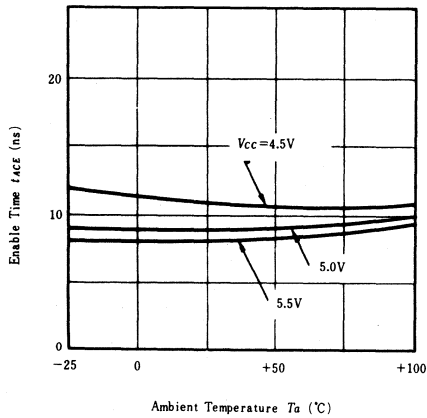

**ENABLE TIME vs.
AMBIENT TEMPERATURE
(HN25045)**

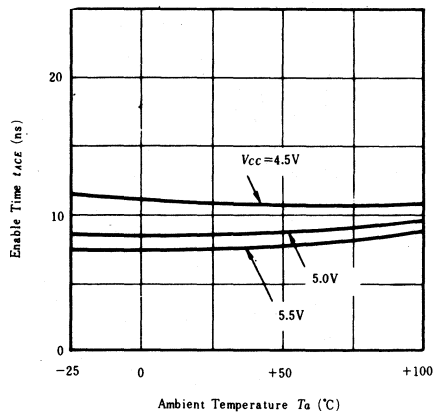

**DELAY TIME INCREASE vs.
LOAD CAPACITANCE
(HN25044)**

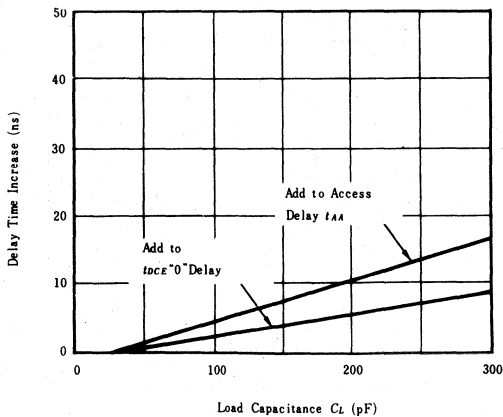

**DELAY TIME INCREASE vs.
LOAD CAPACITANCE
(HN25045)**

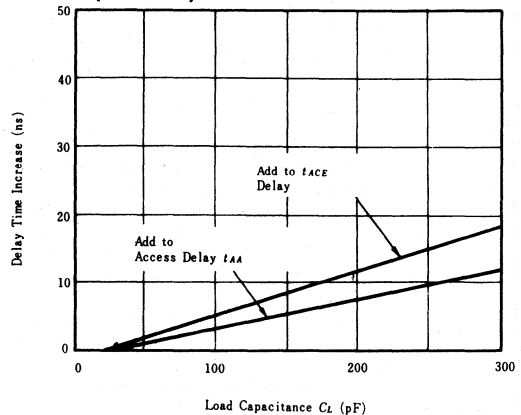

HN25084, HN25085

2048-word × 4-bit Programmable Read Only Memories

The HITACHI HN25084 and HN25085 are high speed electrically programmable, fully decoded TTL Bipolar 8192 bit read only memories organized as 2048 word by 4 bit with on-chip address decoding and one chip enable input. The HN25084 and HN25085 are fabricated with logic level "zeros" (low); logic level "ones" (high) can be electrically programmed in the selected bit locations. The same address inputs are used for both programming and reading.

■ FEATURES

- 2048 word × 4 bit organization (fully decoded)
- TTL compatible inputs and outputs
- Fast read access time: 40 ns typ. (60 ns max)
- Medium power consumption: 550 mW typ.
- One chip enable input for memory expansion
- Open collector outputs (HN25084)/Three-state outputs (HN25085)
- Standard cerdip 18-pin dual in-line package

■ OPERATION

● Programming

A logic one can be permanently programmed into a selected bit location by using programming equipment. First, the desired word is selected by the ten address inputs in TTL level. The device is disabled by bringing \overline{CE} to a logic "one". Then a train of high current programming pulses is applied to the desired output. After the sensed voltage indicates that the selected bit is in the logic "one" state, an additional pulse train is applied, then is stopped.

● Reading

To read the memory the device is enabled by bringing \overline{CE} to a logic "zero". The outputs then correspond to the data programmed in the selected word.

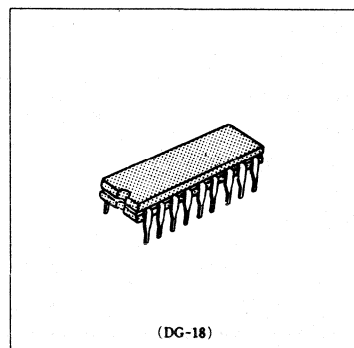

■ PIN ARRANGEMENT

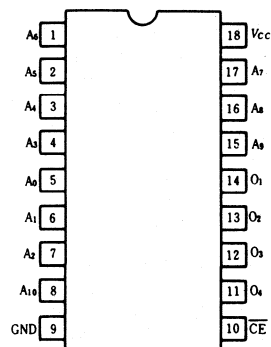

(Top View)

■ LOGIC DIAGRAM

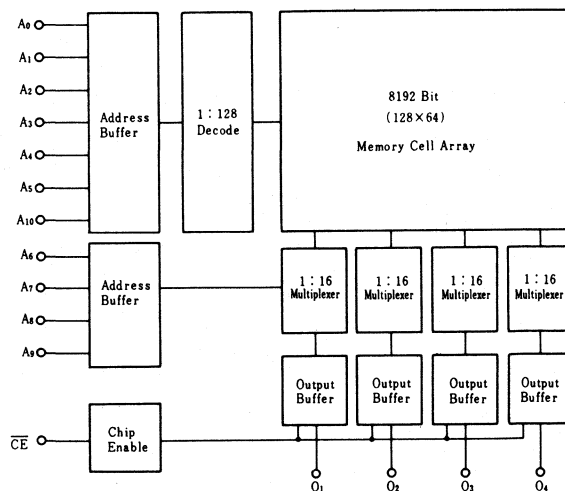

■ ABSOLUTE MAXIMUM RATINGS

Item	Symbol	Rating	Unit
Supply Voltage	V_{CC}	-0.5 to +7.0	V
Input Voltage	V_{in}	-0.5 to +5.5	V
Output Voltage	V_{out}	-0.5 to +5.5	V
Output Current	I_{out}	50	mA
Operating Temperature	T_{op}	-25 to +75	°C
Storage Temperature	T_{stg}	-65 to +150	°C

■ DC CHARACTERISTICS ($V_{CC}=4.75$ to $5.25V$, $T_a=0$ to $75^\circ C$)

Characteristic	Symbol	Test Conditions	min	typ	max	Unit
Input High Voltage	V_{IH}		2.0	—	—	V
Input Low Voltage	V_{IL}		—	—	0.8	V
Input High Current	I_{IH}	$V_I=2.7V$	—	—	40	μA
Input Low Current	$-I_{IL}$	$V_I=0.4V$	—	—	0.40	mA
Output Low Voltage	V_{OL}	$I_{OL}=16mA$	—	—	0.45	V
Output Leakage Current	I_{OLK1}	$V_O=5.25V$	—	—	100	μA
Output Leakage Current	I_{OLK2}	$V_O=0.4V$	—	—	40	μA
Input Clamp Voltage	V_I	$I_I=-18mA$	—	—	-1.2	V
Power Supply Current	I_{CC}	Inputs Either Open or at Ground	—	110	150	mA
Output High Voltage*	V_{OH}	$I_O=-2mA$	2.4	—	—	V
Output Short Circuit Current*	$-I_{OS}$	$V_O=0V$	15	—	60	mA

* Note: Applicable to HN25089 only.

■ AC CHARACTERISTICS ($V_{CC}=4.75$ to $5.25V$, $T_a=0$ to $75^\circ C$)

Characteristic	Symbol	Test Conditions	min	typ	max	Unit
Address Access Time	t_{AA}		—	40	60	ns
Chip Enable Access Time	t_{ACE}		—	25	35	ns
Chip Enable Disable Time	t_{DCE}		—	25	35	ns

Note) 1. Output Load: See Test Circuit.
 2. Measurement Reference: 1.5V for both inputs and outputs.

■ SWITCHING WAVEFORMS

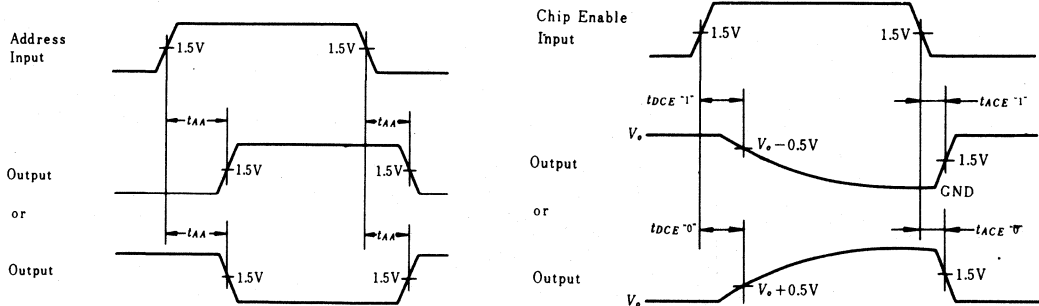

■ SWITCHING TIME TEST CONDITIONS

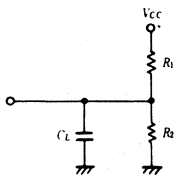

SWITCHING PARAMETER	HN25084			HN25085		
	R_1	R_2	C_L	R_1	R_2	C_L
t_{AA}	300Ω	600Ω	30pF	300Ω	600Ω	30pF
t_{ACE} "1"	—	—	—	∞	600Ω	10pF
t_{ACE} "0"	300Ω	600Ω	10pF	300Ω	600Ω	10pF
t_{DCE} "1"	—	—	—	∞	600Ω	30pF
t_{DCE} "0"	300Ω	600Ω	30pF	300Ω	600Ω	30pF

INPUT CONDITIONS
 Amplitude—0V to 3V
 Rise and Fall time—5ns from 1V to 2V
 Frequency—1MHz

■ PROGRAMMING SPECIFICATION

Characteristic	Limit	Unit	Notes
Ambient Temperature	25±5	°C	
Programming Pulse			
Amplitude	130±5%	mA	
Clamp Voltage	20±2%	V	
Ramp Rate	70max	V/μs	
Pulse Width	7.5±5%	μs	10V point/150Ω load
Duty Cycle	70% min		
Sense Current			
Amplitude	20±0.5	mA	
Clamp Voltage	20±2%	V	
Ramp Rate	70max	V/μs	
Sense Current Interruption before and after address change	10min	μs	
Programming V_{CC}	5.0+5%—0%	V	
Maximum Sensed Voltage for programmed "1"	7.5±0.1	V	
Delay from trailing edge of programming pulse before sensing output voltage	0.7min	μs	
Programming Pulse Number	100max	ms	
Additional Programming Pulse Number	4	Time	

■ TYPICAL WAVEFORMS

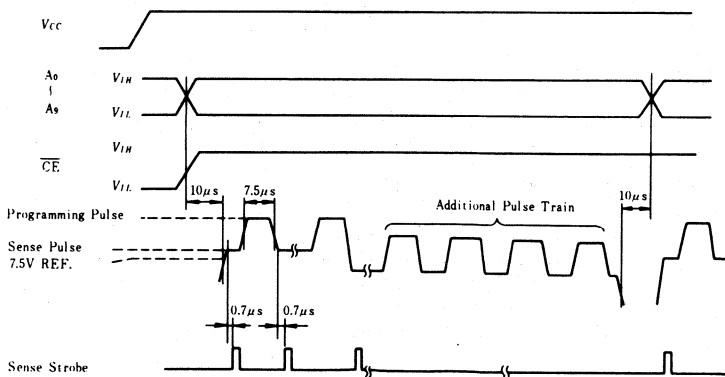

HN25084S, HN25085S

2048-word × 4-bit Programmable Read Only Memories

The HITACHI HN25084S and HN25085S are high speed electrically programmable, fully decoded TTL Bipolar 8192 bit read only memories organized as 2048 words by 4 bits with on-chip address decoding and one chip enable input. The HN25084S and HN25085S are fabricated with logic level "zeros" (low); logic level "ones" (high) can be electrically programmed in the selected bit locations. The same address inputs are used for both programming and reading.

■ FEATURES

- 2048 words × 4 bits organization (fully decoded)
- TTL compatible inputs and outputs
- Fast read access time: 25 ns typ. (50 ns max)
- Medium power consumption: 550 mW typ.
- One chip enable input for memory expansion
- Open collector outputs (HN25084S)/Three-state outputs (HN25085S)
- Standard cerdip 18-pin dual in-line package.

■ OPERATION

● Programming

A logic one can be permanently programmed into a selected bit location by using programming equipment. First, the desired word is selected by the ten address inputs in TTL level. The device is disabled by bringing \overline{CE} to a logic "one". Then a train of high current programming pulses is applied to the desired output. After the sensed voltage indicates that the selected bit is in the logic "one" state, an additional pulse train is applied, then is stopped.

● Reading

To read the memory the device is enabled by bringing \overline{CE} to a logic "zero". The outputs then correspond to the data programmed in the selected word.

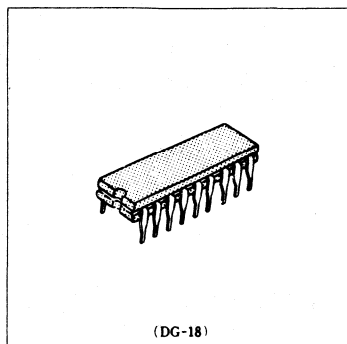

(DG-18)

■ PIN ARRANGEMENT

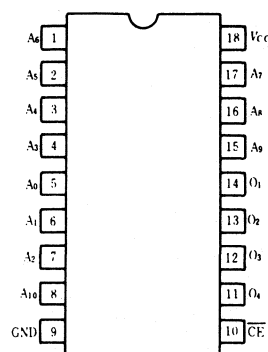

(Top View)

■ LOGIC DIAGRAM

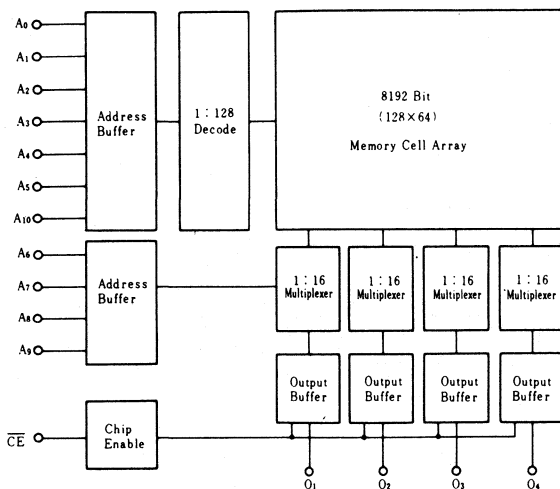

■ ABSOLUTE MAXIMUM RATINGS

Item	Symbol	Rating	Unit
Supply Voltage	V_{CC}	-0.5 to +7.0	V
Input Voltage	V_{in}	-0.5 to +5.5	V
Output Voltage	V_{out}	-0.5 to +5.5	V
Output Current	I_{out}	50	mA
Operating Temperature	T_{opr}	-25 to +75	°C
Storage Temperature	T_{stg}	-65 to +150	°C

■ DC CHARACTERISTICS ($V_{CC}=4.75$ to $5.25V$, $T_a=0$ to $75^{\circ}C$)

Characteristic	Symbol	Test Conditions	min	typ	max	Unit
Input High Voltage	V_{IH}		2.0	—	—	V
Input Low Voltage	V_{IL}		—	—	0.8	V
Input High Current	I_{IH}	$V_i=2.7V$	—	—	40	μA
Input Low Current	$-I_{IL}$	$V_i=0.4V$	—	—	0.40	mA
Output Low Voltage	V_{OL}	$I_o=16mA$	—	—	0.45	V
Output Leakage Current	I_{OLK1}	$V_o=5.25V$	—	—	100	μA
Output Leakage Current	I_{OLK2}	$V_o=0.4V$	—	—	40	μA
Input Clamp Voltage	V_i	$I_i=-18mA$	—	—	-1.2	V
Power Supply Current	I_{CC}	Inputs Either Open or at Ground	—	110	160	mA
Output High Voltage*	V_{OH}	$I_o=-2mA$	2.4	—	—	V
Output Short Circuit Current*	$-I_{OS}$	$V_o=0V$	15	—	60	mA

* Note: Applicable to HN25089 only.

■ AC CHARACTERISTICS ($V_{CC}=4.75$ to $5.25V$, $T_a=0$ to $75^{\circ}C$)

Characteristic	Symbol	Test Conditions	min	typ	max	Unit
Address Access Time	t_{AA}		—	25	50	ns
Chip Enable Access Time	t_{ACE}		—	20	35	ns
Chip Enable Disable Time	t_{DCE}		—	15	35	ns

Note) 1. Output Load: See Test Circuit.

2. Measurement Reference: 1.5V for both inputs and outputs.

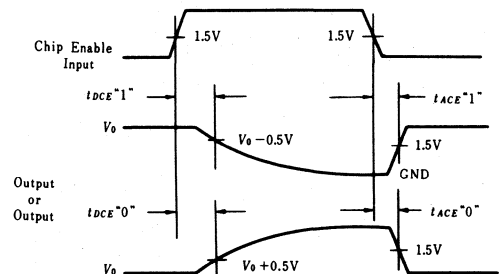
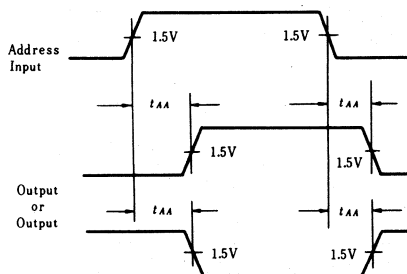
■ SWITCHING WAVEFORMS

■ SWITCHING TIME TEST CONDITIONS

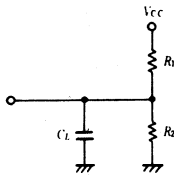

SWITCHING PARAMETER	HN25084S			HN25085S		
	R_1	R_2	C_L	R_1	R_2	C_L
t_{AA}	300Ω	600Ω	30pF	300Ω	600Ω	30pF
t_{ACE} "1"	—	—	—	∞	600Ω	10pF
t_{ACE} "0"	300Ω	600Ω	10pF	300Ω	600Ω	10pF
t_{DCE} "1"	—	—	—	∞	600Ω	30pF
t_{DCE} "0"	300Ω	600Ω	30pF	300Ω	600Ω	30pF

INPUT CONDITIONS
 Amplitude—0V to 3V
 Rise and Fall time—5ns from 1V to 2V
 Frequency—1MHz

■ PROGRAMMING SPECIFICATION

PARAMETER	Symbol	min	typ	max	Unit	Note
Ambient Temperature	T_a	20	25	30	°C	
Programming V_{CC}	V_{CC}	4.75	5.0	5.25	V	
Programming Pulse						
Amplitude	I_w	88	90	92	mA	
Clamp Voltage	V_w	19.0	19.5	20.0	V	
Ramp Rate		10	—	70	V/μs	
Pulse Width	t_{PW}	7.1	7.5	7.9	μs	9V point/200Ω load
Duty Cycle		70	—	—	%	
Sense Current						
Amplitude	I_s	19	20	21	mA	
Sense Voltage	V_s	7.4	7.5	7.6	V	
Clamp Voltage		19.0	19.5	20.0	V	
Ramp Rate		70	—	—	V/μs	
Address Setup Time	t_{SA}	10	—	—	μs	
Address Hold Time	t_{HA}	10	—	—	μs	
Sense Setup Time	t_{SS}	0.7	—	—	μs	
Sense Hold Time	t_{HS}	0.7	—	—	μs	
Additional Programming Pulse		1	1	1	time	
Programming Pulse Number per bit	n	—	—	10000	time	

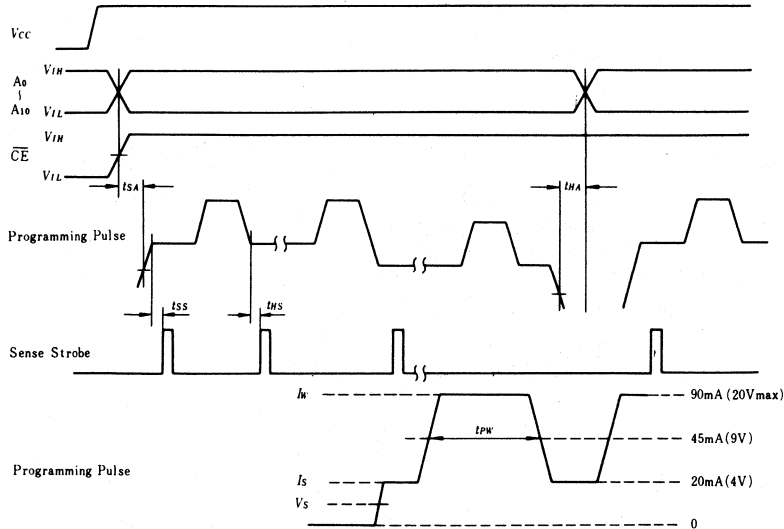

() : 200Ω load

HN25088, HN25089

1024-word × 8-bit Programmable Read Only Memories

The HITACHI HN25088 and HN25089 are high speed electrically programmable, fully decoded TTL Bipolar 8192 bit read only memories organized as 1024 words by 8 bits with on-chip address decoding and four chip enable inputs. The HN25088 and HN25089 are fabricated with logic level "zeros" (low); logic level "ones" (high) can be electrically programmed in the selected bit locations. The same address inputs are used for both programming and reading.

■ FEATURES

- 1024 words × 8 bits organization (fully decoded)
- TTL compatible inputs and outputs
- Fast read access time: 40 ns (typ), 60 ns (max)
- Medium power consumption: 600 mW typ.
- Four chip enable inputs for memory expansion
- Open collector outputs (HN25088)/Three-state outputs (HN25089)
- Standard cerdip 24-pin dual in-line package

■ OPERATION

● Programming

A logic one can be permanently programmed into a selected bit location by using programming equipment. First, the desired word is selected by the ten address inputs in TTL level. The device is disabled by bringing $\overline{CE1}$ and/or $\overline{CE2}$ to as logic "one" or $CE3$ and/or $CE4$ to a logic "zero". Then a train of high current programming pulses is applied to the desired output. After the sensed voltage indicates that the selected bit is in the logic one state, an additional pulse train is applied, then is stopped.

● Reading

To read the memory the device is enabled by bringing $\overline{CE1}$ and $\overline{CE2}$ to a logic "zero". $CE3$ and $CE4$ to a logic "one". The outputs then correspond to the data programmed in the selected word.

■ LOGIC DIAGRAM

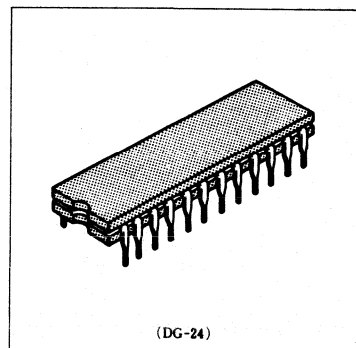
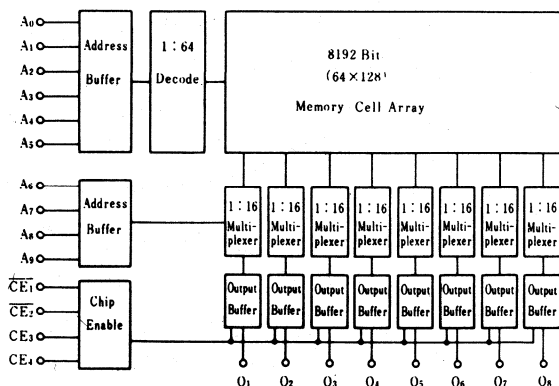

(DG-24)

■ PIN ARRANGEMENT

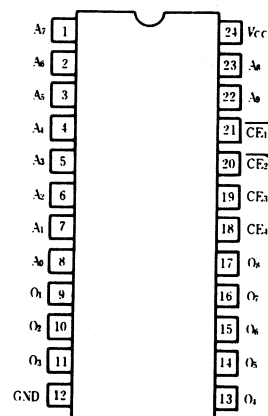

(Top View)

■ ABSOLUTE MAXIMUM RATINGS

Item	Symbol	Rating	Unit
Supply Voltage	V_{CC}	-0.5 to +7.0	V
Input Voltage	V_{in}	-0.5 to +5.5	V
Output Voltage	V_{out}	-0.5 to +5.5	V
Output Current	I_{out}	50	mA
Operating Temperature	T_{opr}	-25 to +75	°C
Storage Temperature	T_{stg}	-65 to +150	°C

■ DC CHARACTERISTICS ($V_{CC}=4.75$ to $5.25V$, $T_a=0$ to $+75^{\circ}C$)

Characteristic	Symbol	Test Conditions	min	typ	max	Unit
Input High Voltage	V_{IH}		2.0	—	—	V
Input Low Voltage	V_{IL}		—	—	0.8	V
Input High Current	I_{IH}	$V_I=2.7V$	—	—	40	μA
Input Low Current	$-I_{IL}$	$V_I=0.4V$	—	—	0.40	mA
Output Low Voltage	V_{OL}	$I_{OL}=16mA$	—	—	0.45	V
Output Leakage Current	I_{OLK1}	$V_O=5.25V$	—	—	100	μA
Output Leakage Current	I_{OLK2}	$V_O=0.4V$	—	—	40	μA
Input Clamp Voltage	V_I	$I_I=-18mA$	—	—	-1.2	V
Power Supply Current	I_{CC}	Inputs Either Open or at Ground	—	120	160	mA
Output High Voltage*	V_{OH}	$I_{OH}=-2mA$	2.4	—	—	V
Output Short Circuit Current*	$-I_{OS}$	$V_O=0V$	15	—	60	mA

* Note: Applicable to HN25089 only.

■ AC CHARACTERISTICS ($V_{CC}=4.75$ to $5.25V$, $T_a=0$ to $75^{\circ}C$)

Characteristic	Symbol	Test Conditions	min	typ	max	Unit
Address Access Time	t_{AA}		—	40	60	ns
Chip Enable Access Time	t_{ACE}		—	20	35	ns
Chip Enable Disable Time	t_{DCE}		—	20	35	ns

Note) 1. Output Load: See Test Circuit.
 2. Measurement Reference: 1.5V for both inputs and outputs.

■ SWITCHING WAVEFORMS

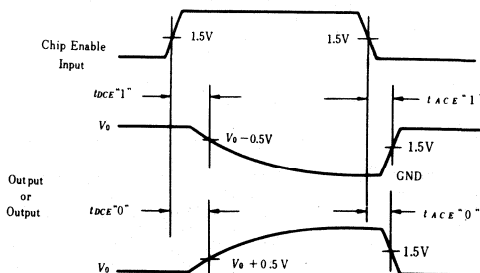
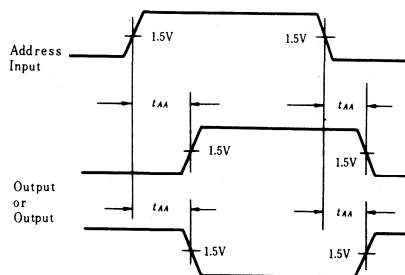

■ SWITCHING TIME TEST CONDITIONS

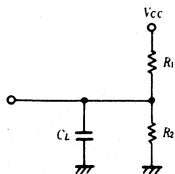

SWITCHING PARAMETER	HN25088			HN25089		
	R_1	R_2	C_L	R_1	R_2	C_L
t_{AA}	300 Ω	600 Ω	30pF	300 Ω	600 Ω	30pF
t_{ACE} "1"	—	—	—	∞	600 Ω	10pF
t_{ACE} "0"	300 Ω	600 Ω	10pF	300 Ω	600 Ω	10pF
t_{DCE} "1"	—	—	—	∞	600 Ω	30pF
t_{DCE} "0"	300 Ω	600 Ω	30pF	300 Ω	600 Ω	30pF

INPUT CONDITIONS
 Amplitude—0V to 3V
 Rise and Fall time—5ns from 1V to 2V
 Frequency—1MHz

■ PROGRAMMING SPECIFICATION

Characteristic	Limit	Unit	Notes
Ambient Temperature	25 \pm 5	$^{\circ}$ C	
Programming Pulse			
Amplitude	130 \pm 5%	mA	
Clamp Voltage	20 \pm 2%	V	
Ramp Rate	70max	V/ μ s	
Pulse Width	7.5 \pm 5%	μ s	10V point/150 Ω load
Duty Cycle	70% min		
Sense Current			
Amplitude	20 \pm 0.5	mA	
Clamp Voltage	20 \pm 2%	V	
Ramp Rate	70max	V/ μ s	
Sense Current Interruption before and after address change	10min	μ s	
Programming V_{CC}	5.0+5%—0%	V	
Maximum Sensed Voltage for programmed "1"	7.5 \pm 0.1	V	
Delay from trailing edge of programming pulse before sensing output voltage	0.7min	μ s	
Programming Pulse Number	100max	ms	
Additional Programming Pulse Number	4	Time	

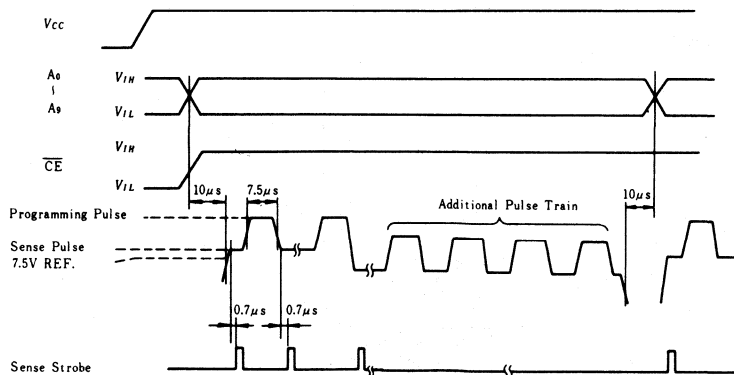

HN25088S, HN25089S

1024-word × 8-bit Programmable Read Only Memories

The HITACHI HN25088S and HN25089S are high speed electrically programmable, fully decoded TTL Bipolar 8192 bit-read only memories organized as 1024 words by 8 bits with on-chip address decoding and four chip enable inputs. The HN25088S and HN25089S are fabricated with logic level "zeros" (low); logic level "ones" (high) can be electrically programmed in the selected bit locations. The same address inputs are used for both programming and reading.

■ FEATURES

- 1024 words × 8 bits organization (fully decoded)
- TTL compatible inputs and outputs
- Fast read access time: 25 ns typ. (50 ns max)
- Medium power consumption: 600 mW typ.
- Four chip enable inputs for memory expansion
- Open collector outputs (HN25088S)/Three-state outputs (HN25089S)
- Standard cerdip 24-pin dual in-line package

■ OPERATION

● Programming

A logic one can be permanently programmed into a selected bit location by using programming equipment. First, the desired word is selected by the ten address inputs in TTL level. The device is disabled by bringing $\overline{CE1}$ and/or $\overline{CE2}$ to as logic "one" or $\overline{CE3}$ and/or $\overline{CE4}$ to a logic "zero". Then a train of high current programming pulses is applied to the desired output. After the sensed voltage indicates that the selected bit is in the logic one state, an additional pulse train is applied, then is stopped.

● Reading

To read the memory the device is enabled by bringing $\overline{CE1}$ and $\overline{CE2}$ to a logic "zero", $\overline{CE3}$ and $\overline{CE4}$ to a logic "one". The outputs then correspond to the data programmed in the selected word.

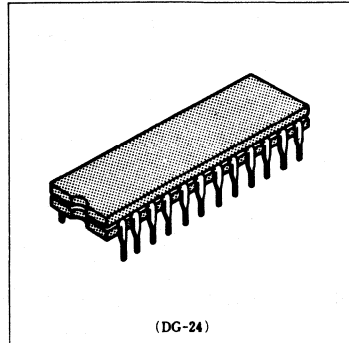

(DG-24)

■ PIN ARRANGEMENT

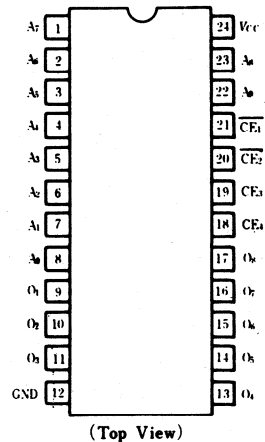

(Top View)

■ LOGIC DIAGRAM

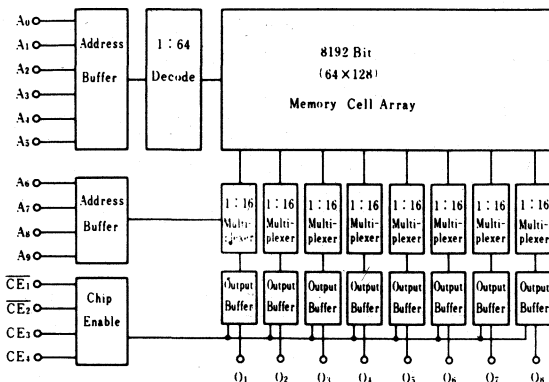

■ ABSOLUTE MAXIMUM RATINGS

Item	Symbol	Rating	Unit
Supply Voltage	V_{CC}	-0.5 to +7.0	V
Input Voltage	V_{in}	-0.5 to +5.5	V
Output Voltage	V_{out}	-0.5 to +5.5	V
Output Current	I_{out}	50	mA
Operating Temperature	T_{op}	-25 to +75	°C
Storage Temperature	T_{stg}	-65 to +150	°C

■ DC CHARACTERISTICS ($V_{CC}=4.75$ to $5.25V$, $T_a=0$ to $+75^\circ C$)

Characteristic	Symbol	Test Conditions	min	typ	max	Unit
Input High Voltage	V_{IH}		2.0	—	—	V
Input Low Voltage	V_{IL}		—	—	-0.8	V
Input High Current	I_{IH}	$V_I=2.7V$	—	—	40	μA
Input Low Current	$-I_{IL}$	$V_I=0.4V$	—	—	0.40	mA
Output Low Voltage	V_{OL}	$I_{OL}=16mA$	—	—	0.45	V
Output Leakage Current	I_{OLK1}	$V_O=5.25V$	—	—	100	μA
Output Leakage Current	I_{OLK2}	$V_O=0.4V$	—	—	40	μA
Input Clamp Voltage	V_I	$I_I=-18mA$	—	—	-1.2	V
Power Supply Current	I_{CC}	Inputs Either Open or at Ground	—	120	160	mA
Output High Voltage*	V_{OH}	$I_{OH}=-2mA$	2.4	—	—	V
Output Short Circuit Current*	$-I_{OS}$	$V_O=0V$	15	—	60	mA

* Note: Applicable to HN25089S only.

■ AC CHARACTERISTICS ($V_{CC}=4.75$ to $5.25V$, $T_a=0$ to $75^\circ C$)

Characteristic	Symbol	Test Conditions	min	typ	max	Unit
Address Access Time	t_{AA}		—	25	50	ns
Chip Enable Access Time	t_{ACE}		—	20	35	ns
Chip Enable Disable Time	t_{DCE}		—	15	35	ns

Note) 1. Output Load: See Test Circuit.
2. Measurement Reference: 1.5V for both inputs and outputs.

■ SWITCHING WAVEFORMS

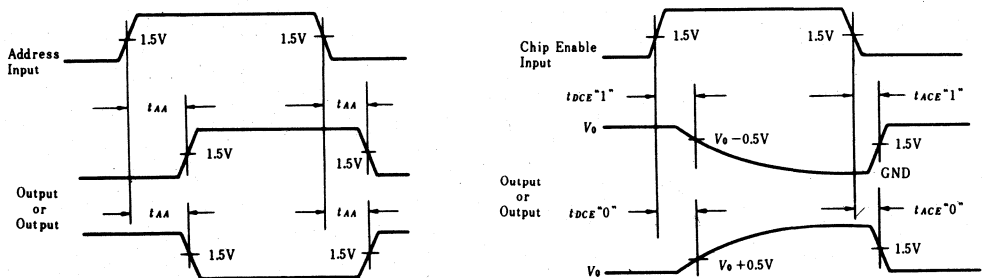

■ SWITCHING TIME TEST CONDITIONS

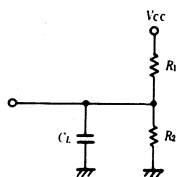

SWITCHING PARAMETER	HN25088S			HN25089S		
	R_1	R_2	C_L	R_1	R_2	C_L
t_{AA}	300Ω	600Ω	30pF	300Ω	600Ω	30pF
t_{ACE} "1"	—	—	—	∞	600Ω	10pF
t_{ACE} "0"	300Ω	600Ω	10pF	300Ω	600Ω	10pF
t_{DCE} "1"	—	—	—	∞	600Ω	30pF
t_{DCE} "0"	300Ω	600Ω	30pF	300Ω	600Ω	30pF

INPUT CONDITIONS
 Amplitude—0V to 3V
 Rise and Fall time—5ns from 1V to 2V
 Frequency—1MHz

■ PROGRAMMING SPECIFICATION

PARAMETER	Symbol	min	typ	max	Unit	Note
Ambient Temperature	T_a	20	25	30	°C	
Programming V_{CC}	V_{CC}	4.75	5.0	5.25	V	
Programming Pulse						
Amplitude	I_w	88	90	92	mA	
Clamp Voltage	V_w	19.0	19.5	20.0	V	
Ramp Rate		10	—	70	V/ μ s	
Pulse Width	t_{PW}	7.1	7.5	7.9	μ s	9V point/200Ω load
Duty Cycle		70	—	—	%	
Sense Current						
Amplitude	I_s	19	20	21	mA	
Sense Voltage	V_s	7.4	7.5	7.6	V	
Clamp Voltage		19.0	19.5	20.0	V	
Ramp Rate		70	—	—	V/ μ s	
Address Setup Time	t_{SA}	10	—	—	μ s	
Address Hold Time	t_{HA}	10	—	—	μ s	
Sense Setup Time	t_{SS}	0.7	—	—	μ s	
Sense Hold Time	t_{HS}	0.7	—	—	μ s	
Additional Programming Pulse		1	1	1	time	
Programming Pulse Number per bit	n	—	—	10000	time	

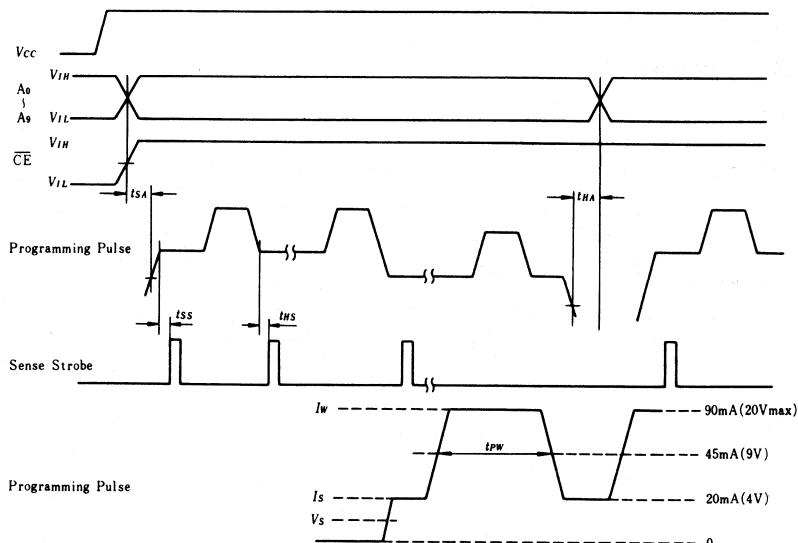

HN25088L, HN25089L

1024-word × 8-bit Programmable Read Only Memories

The HITACHI HN25088L and HN25089L are low power and high speed electrically programmable, fully decoded TTL Bipolar 8192 bit read only memories organized as 1024 words by 8 bits with on-chip address decoding and four chip enable inputs.

The HN25088L and HN25089L are fabricated with logic level "zeros" (low); logic level "ones" (high) can be electrically programmed in the selected bit locations. The same address inputs are used for both programming and reading.

FEATURES

- 1024 words x 8 bits organization (fully decoded)
- TTL compatible inputs and outputs
- Fast read access time: 60ns typ. (100ns max.)
- Low power consumption: 350mW typ.
- Four chip enable inputs for memory expansion
- Open collector outputs (HN25088L)/Three-state outputs (HN25089L)

OPERATION

Programming

A logic one can be permanently programmed into a selected bit location by using programming equipment. First, the desired word is selected by the ten address inputs in TTL level. The device is disabled by bringing $\overline{CE1}$ and/or $\overline{CE2}$ to as logic "one" or $\overline{CE3}$ and/or $\overline{CE4}$ to a logic "zero". Then a train of high current programming pulses is applied to the desired output. After the sensed voltage indicates that the selected bit is in the logic one state, an additional pulse train is applied, then is stopped.

Reading

To read the memory the device is enabled by bringing $\overline{CE1}$ and $\overline{CE2}$ to a logic "zero", $\overline{CE3}$ and $\overline{CE4}$ to a logic "one". The outputs then correspond to the data programmed in the selected word.

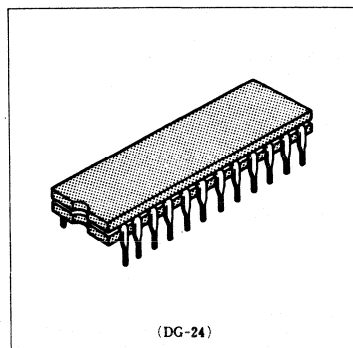

PIN ARRANGEMENT

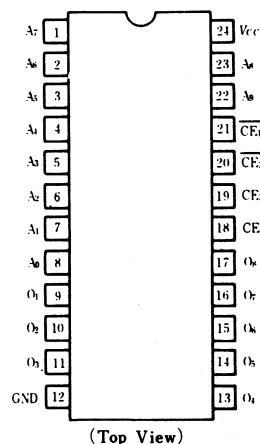

LOGIC DIAGRAM

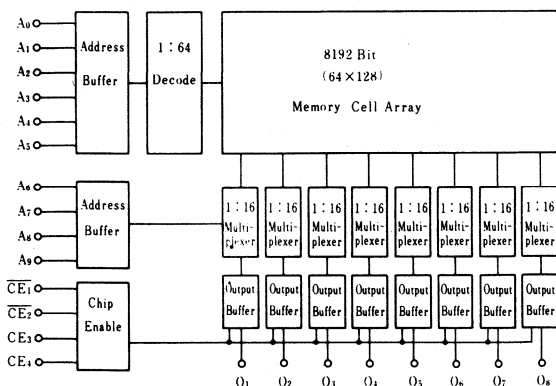

■ ABSOLUTE MAXIMUM RATINGS

Item	Symbol	Rating	Unit
Supply Voltage	V_{CC}	-0.5 to +7.0	V
Input Voltage	V_{in}	-0.5 to +5.5	V
Output Voltage	V_{out}	-0.5 to +5.5	V
Output Current	I_{out}	50	mA
Operating Temperature	T_{opr}	-25 to +75	°C
Storage Temperature	T_{stg}	-65 to +150	°C

■ DC CHARACTERISTICS ($V_{CC}=4.75$ to $5.25V$, $T_a=0$ to $+75^{\circ}C$)

Item	Symbol	Test Conditions	min	typ	max	Unit
Input Voltage	V_{IH}		2.0	—	—	V
	V_{IL}		—	—	0.8	V
Output Voltage	V_{OH}^*	$I_{OH} = -2mA$	2.4	—	—	V
	V_{OL}	$I_{OL} = 16mA$	—	—	0.45	V
Input Current	I_{IH}	$V_I = 2.7V$	—	—	40	μA
	$-I_{IL}$	$V_I = 0.4V$	—	—	0.4	mA
Output Leakage Current	I_{OLK}	$V_O = 5.25V$	—	—	100	μA
		$V_O = 0.4V$	—	—	40	μA
Supply Current	I_{CC}	Inputs Either Open or at Ground	—	70	100	mA
Output Short-circuit Current	$-I_{OS}^*$	$V_O = 0V$	8	—	30	mA
Input Clamp Voltage	V_I	$I_I = -18mA$	—	—	-1.2	V

* Applicable to HN25089L only.

■ AC CHARACTERISTICS ($V_{CC}=4.75$ to $5.25V$, $T_a=0$ to $+75^{\circ}C$)

Item	Symbol	min	typ	max	Unit
Address Access Time	t_{AA}	—	60	100	ns
Chip Enable Access Time	t_{ACE}	—	40	70	ns
Chip Enable Disable Time	t_{DCE}	—	40	70	ns

Notes) 1. Output Load: See Test Circuit
 2. Measurement Reference: 1.5V for both inputs and outputs

■ SWITCHING WAVEFORMS

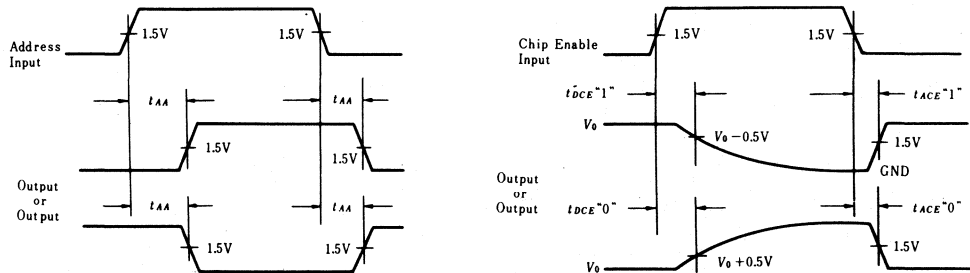

■ SWITCHING TIME TEST CONDITIONS

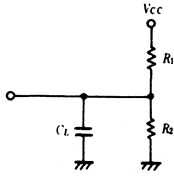

SWITCHING PARAMETER	HN25088L			HN25089L		
	R_1	R_2	C_L	R_1	R_2	C_L
t_{AA}	300Ω	600Ω	30pF	300Ω	600Ω	30pF
t_{ACE} "1"	—	—	—	∞	600Ω	10pF
t_{ACE} "0"	300Ω	600Ω	10pF	300Ω	600Ω	10pF
t_{DCE} "1"	—	—	—	∞	600Ω	30pF
t_{DCE} "0"	300Ω	600Ω	30pF	300Ω	600Ω	30pF

INPUT CONDITIONS
 Amplitude - 0V to 3V
 Rise and Fall time - 5ns from 1V to 2V
 Frequency - 1MHz

■ PROGRAMMING SPECIFICATION

Characteristic	Limit	Unit	Notes
Ambient Temperature	25±5	°C	
Programming Pulse			
Amplitude	130±5%	mA	
Clamp Voltage	20±2%	V	
Ramp Rate	70max	V/μs	
Pulse Width	7.5±5%	μs	10V point/150Ω load
Duty Cycle	70% min		
Sense Current			
Amplitude	20±0.5	mA	
Clamp Voltage	20±2%	V	
Ramp Rate	70max	V/μs	
Sense Current Interruption before and after address change	10min	μs	
Programming V_{CC}	5.0+5% - 0%	V	
Maximum Sensed Voltage for programmed "1"	7.5±0.1	V	
Delay from trailing edge of programming pulse before sensing output voltage	0.7min	μs	
Programming Pulse Number	100max	ms	
Additional Programming Pulse Number	4	Time	

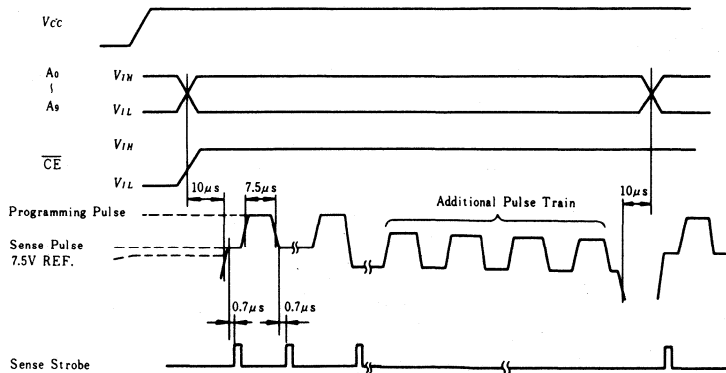

HN25168S, HN25169S

2048-word × 8-bit Programmable Read Only Memories

The HITACHI HN25168S and HN25169S are high speed electrically programmable, fully decoded TTL Bipolar 16384 bit read only memories organized as 2048 words by 8 bits with on-chip address decoding and three chip enable inputs. The HN25168S and HN25166S are fabricated with logic level "zeros" (low); logic level "ones" (high) can be electrically programmed in the selected bit locations. The same address inputs are used for both programming and reading.

FEATURES

- 2048 words × 8 bits organization (fully decoded)
- TTL compatible inputs and outputs
- Fast read access time: 40 ns typ. (60 ns max)
- Medium power consumption: 600 mW typ.
- Three chip enable inputs for memory expansion.
- Open collector outputs (HN25168S)/Three-state outputs (HN25169S)
- Standard cerdip 24-pin dual in-line package

OPERATION

Programming

A logic one can be permanently programmed into a selected bit location by using programming equipment. First, the desired word is selected by the eleven address inputs in TTL level. The device is disabled by bringing CE1 to as logic "one" or CE2 and/or CE3 to a logic "zero". Then a train of high current programming pulses is applied to the desired output. After the sensed voltage indicates that the selected bit is in the logic one state, an additional pulse is applied, then is stopped.

Reading

To read the memory the device is enabled by bringing CE1 to a logic "zero", CE2 and CE3 to a logic "one". The outputs then correspond to the data programmed in the selected word.

LOGIC DIAGRAM

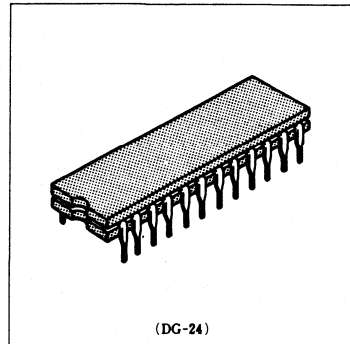
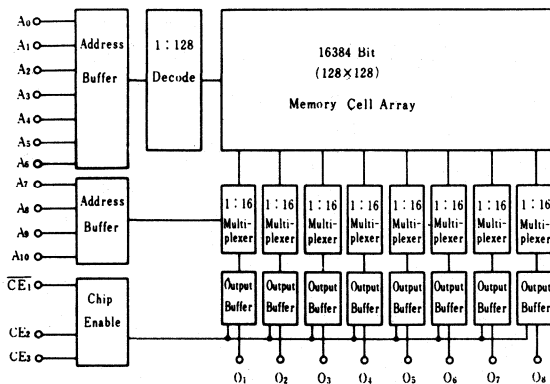

PIN ARRANGEMENT

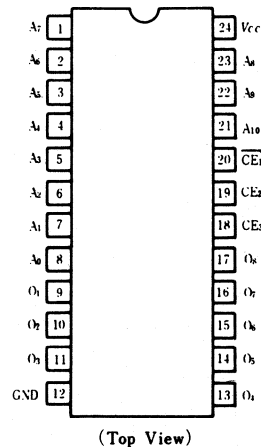

■ ABSOLUTE MAXIMUM RATINGS

Item	Symbol	Rating	Unit
Supply Voltage	V_{CC}	-0.5 to +7.0	V
Input Voltage	V_{in}	-0.5 to +5.5	V
Output Voltage	V_{out}	-0.5 to +5.5	V
Output Current	I_{out}	50	mA
Operating Temperature	T_{opr}	-25 to +75	°C
Storage Temperature	T_{stg}	-65 to +150	°C

■ DC CHARACTERISTICS ($V_{CC}=4.75$ to $5.25V$, $T_a=0$ to $+75^\circ C$)

Characteristic	Symbol	Test Conditions	min	typ	max	Unit
Input High Voltage	V_{IH}		2.0	—	—	V
Input Low Voltage	V_{IL}		—	—	0.8	V
Input High Current	I_{IH}	$V_I=2.7V$	—	—	40	μA
Input Low Current	$-I_{IL}$	$V_I=0.4V$	—	—	0.40	mA
Output Low Voltage	V_{OL}	$I_{OL}=16mA$	—	—	0.45	V
Output Leakage Current	I_{OLK1}	$V_O=5.25V$	—	—	100	μA
Output Leakage Current	I_{OLK2}	$V_O=0.4V$	—	—	40	μA
Input Clamp Voltage	V_I	$I_I=-18mA$	—	—	-1.2	V
Power Supply Current	I_{CC}	Inputs Either Open or at Ground	—	120	170	mA
Output High Voltage*	V_{OH}	$I_{OH}=-2mA$	2.4	—	—	V
Output Short Circuit Current*	$-I_{OS}$	$V_O=0V$	15	—	60	mA

* Note: Applicable to HN25169S only.

■ AC CHARACTERISTICS ($V_{CC}=4.75$ to $5.25V$, $T_a=0$ to $75^\circ C$)

Characteristic	Symbol	Test Conditions	min	typ	max	Unit
Address Access Time	t_{AA}		—	40	60	ns
Chip Enable Access Time	t_{ACE}		—	20	35	ns
Chip Enable Disable Time	t_{DCE}		—	20	35	ns

Note) 1. Output Load: See Test Circuit.
 2. Measurement Reference: 1.5V for both inputs and outputs.

■ SWITCHING WAVEFORMS

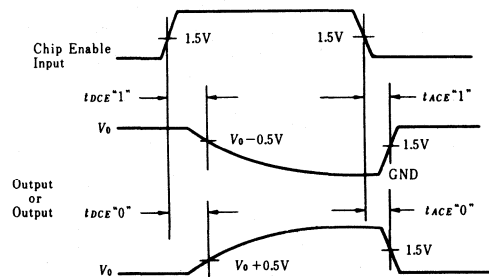
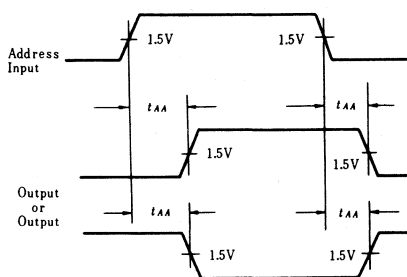

■ SWITCHING TIME TEST CONDITIONS

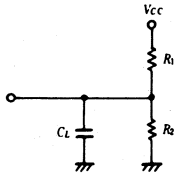

SWITCHING PARAMETER	HN25168S			HN25169S		
	R_1	R_2	C_L	R_1	R_2	C_L
t_{AA}	300Ω	600Ω	30pF	300Ω	600Ω	30pF
t_{ACE} "1"	—	—	—	∞	600Ω	10pF
t_{ACE} "0"	300Ω	600Ω	10pF	300Ω	600Ω	10pF
t_{DCE} "1"	—	—	—	∞	600Ω	30pF
t_{DCE} "0"	300Ω	600Ω	30pF	300Ω	600Ω	30pF

INPUT CONDITIONS
 Amplitude—0V to 3V
 Rise and Fall time—5ns from 1V to 2V
 Frequency—1MHz

■ PROGRAMMING SPECIFICATION

PARAMETER	Symbol	min	typ	max	Unit	Note
Ambient Temperature	T_a	20	25	30	°C	
Programming V_{CC}	V_{CC}	4.75	5.0	5.25	V	
Programming Pulse						
Amplitude	I_w	88	90	92	mA	
Clamp Voltage	V_w	19.0	19.5	20.0	V	
Ramp Rate		10	—	70	V/μs	
Pulse Width	t_{pw}	7.1	7.5	7.9	μs	9V point/200Ω load
Duty Cycle		70	—	—	%	
Sense Current						
Amplitude	I_s	19	20	21	mA	
Sense Voltage	V_s	7.4	7.5	7.6	V	
Clamp Voltage		19.0	19.5	20.0	V	
Ramp Rate		70	—	—	V/μs	
Address Setup Time	t_{SA}	10	—	—	μs	
Address Hold Time	t_{HA}	10	—	—	μs	
Sense Setup Time	t_{SS}	0.7	—	—	μs	
Sense Hold Time	t_{SH}	0.7	—	—	μs	
Additional Programming Pulse		1	1	1	time	
Programming Pulse Number per bit	n	—	—	10000	time	

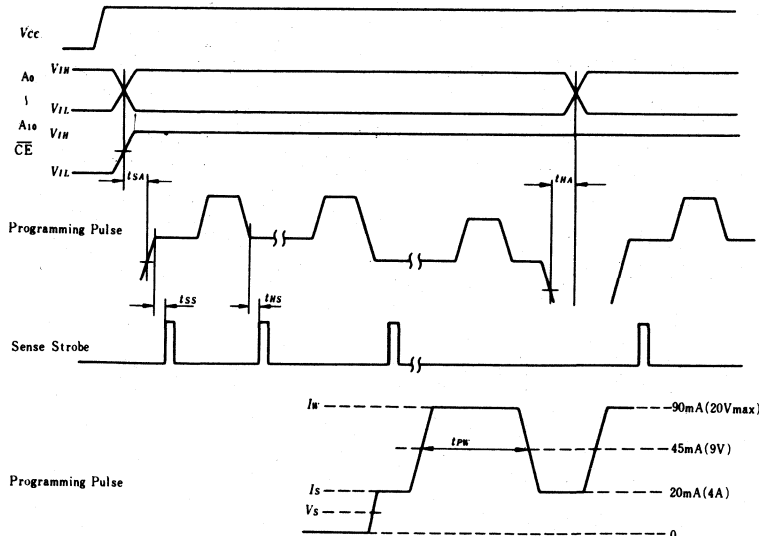

() : 200Ω load

MEMORY SUPPORT CIRCUITS

HD2912

Quadruple TTL-to-MOS Clock Drivers

The HD2912, a clock driver for the MOS memory, has basically the NAND function. Its input is a TTL level and its output becomes an N MOS clock input level. It operates on two power supplies – V_{CC} (5V) and V_{DD} (12V). It anticipates taking as its load a maximum of ten units of 4K-bit N MOS memories and can drive a load capacity of 400 pF at high speed.

- TTL-MOS level converter circuit
- Switching time: 50 ns (max.)
- Load capacity drivable: 600pF
- Mounted with 4 circuits
- Applicable temperature: 0 to 70°C

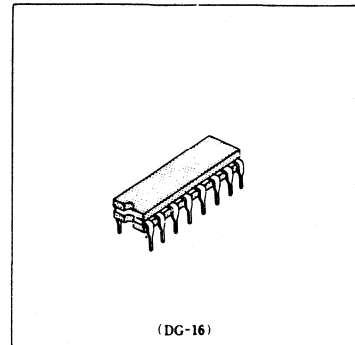

■ ABSOLUTE MAXIMUM RATINGS

Item	Symbol	HD2912	Unit
Supply Voltage	V_{CC}^*	7.0	V
	V_{DD}^*	18.0	V
Input Voltage	$V_{i\alpha}^*$	5.5	V
Load Capacitance	C_L^{**}	600	pF
Power Dissipation	P_T^{***}	800	mW
Operating Temperature	T_{opr}	0 to +70	°C
Storage Temperature	T_{stg}	-65 to +150	°C

- * With respect GND
- ** per circuit
- *** per package

■ PIN ARRANGEMENT

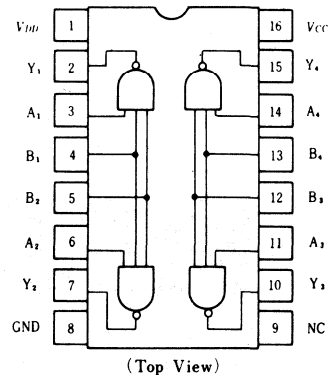

■ RECOMMENDED OPERATING CONDITIONS

Item	Symbol	min	typ	max	Unit
Supply Voltage	V_{CC}	4.75	5.0	5.25	V
	V_{DD}	11.4	12	12.6	V
Operating Temperature	T_{opr}	0	25	70	°C
Load Capacitance	C_L	100	—	600	pF
Damping Resistance	R_D	10	—	—	Ω

■ ELECTRICAL CHARACTERISTICS ($T_a=0$ to +70°C, $V_{CC}=5V \pm 5\%$, $V_{DD}=12V \pm 5\%$)

Item	Symbol	Test Condition	min	typ*	max	Unit	
Input Voltage	V_{IL}		2.0	—	—	V	
	V_{IH}		—	—	0.8	V	
Output Voltage	V_{OL}	$V_{i\alpha}=2V, I_{OL}=0.1mA$	—	0.45	0.6	V	
	V_{OH}	$V_{i\alpha}=0.8V, I_{OH}=-0.1mA$	$V_{DD}-0.9$	11.5	—	V	
Input Current	A	I_{IL}	$V_{i\alpha}=0.4V$	—	-1	mA	
	B	I_{IL}		—	-2	mA	
	A	I_{IH}	$V_{i\alpha}=2.4V$	—	—	40	μA
	B	I_{IH}		—	—	80	μA
Power Supply Current		I_I	$V_{i\alpha}=5.5V$	—	—	1	mA
		I_{DDH}	$V_{i\alpha}=0V$	—	16	24	mA
		I_{DDL}	$V_{i\alpha}=5V$	—	—	0.5	mA
		I_{CCH}	$V_{i\alpha}=0V$	—	12	18	mA
		I_{CCL}	$V_{i\alpha}=5V$	—	67	100	mA
Input Clamp Voltage	V_I	$I_{i\alpha}=-12mA$	—	—	-1.5	V	

* $V_{CC}=5V, V_{DD}=12V$

SWITCHING CHARACTERISTICS ($T_a=0$ to $+70^\circ\text{C}$, $V_{CC}=5\text{V}$, $V_{DD}=12\text{V}$)

Item	Symbol	Test Condition	min	typ	max	Unit
Rising Delay Time	t_{DLH}	$C_L=300\text{pF}$ $R_D=0\Omega$	—	35	50	ns
Falling Delay Time	t_{DHL}		—	25	45	ns
Rise Time	t_{TLH}		—	12	25	ns
Fall Time	t_{THL}		—	12	25	ns

TEST CIRCUIT AND WAVEFORMS

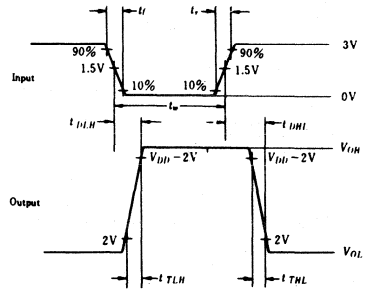
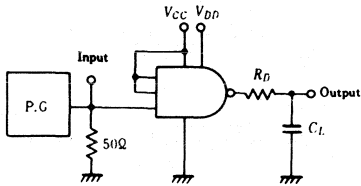

$t_w = 250\text{ns}$, $t_{\text{fall}} = 350\text{ns}$, $t_r = t_f = 10 \pm 1\text{ns}$

FALLING DELAY TIME vs. LOAD CAPACITANCE (1)

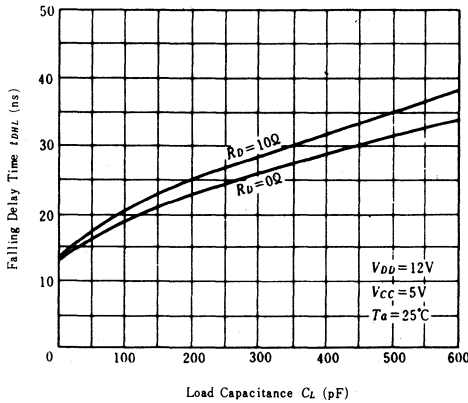

RISING DELAY TIME vs. LOAD CAPACITANCE (2)

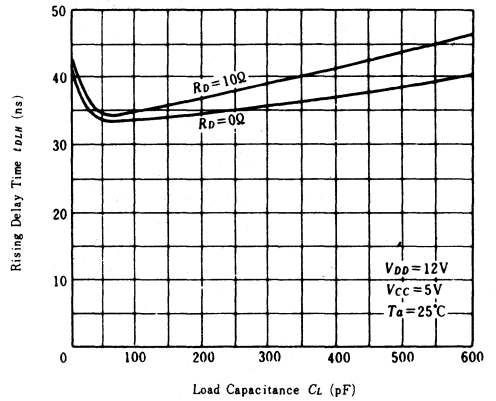

RISE TIME AND RISING DELAY TIME vs. AMBIENT TEMPERATURE

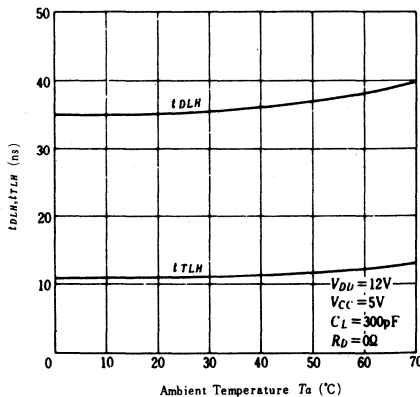

FALL TIME AND FALLING DELAY TIME vs. AMBIENT TEMPERATURE

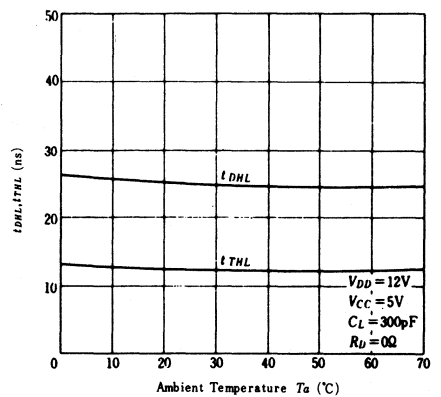

SWITCHING TIME vs. SUPPLY VOLTAGE (1)

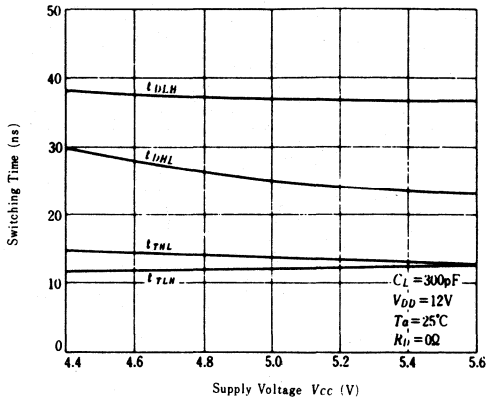

SWITCHING TIME vs. SUPPLY VOLTAGE (2)

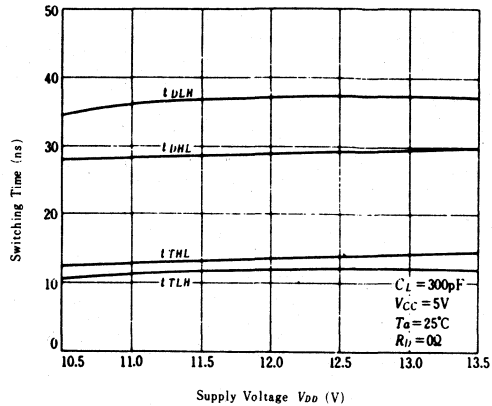

POWER DISSIPATION vs. CYCLE TIME

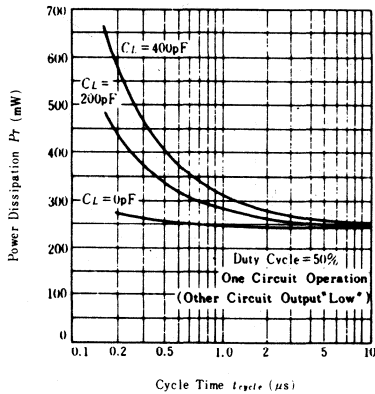

ITEMS REQUIRING CARE WHEN USING THE HD2912

When measuring or mounting the HD2912, consider the following.

1. At the time of "H" level output, if a short circuit occurs between the output terminal and the other terminal (the GND terminal or input terminal), the element will breakdown.
2. When measuring the input/output characteristic of the circuit, do not place the input level in the vicinity of the threshold voltage (about 1.5V) for more than 10 seconds. If this caution is neglected, the element may breakdown.
3. If its load capacity is less than a certain value (100pF), sometimes this element cannot fully provide its function. Take note of this fact when designing a system.
4. When mounting this element, it is recommended providing the output terminal with a damping resistor (R_D) or a diode terminating circuit.

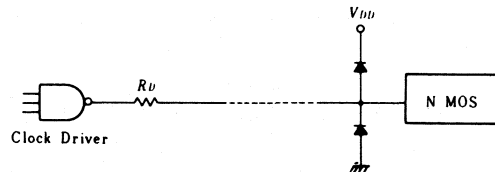

HD2916

Quadruple TTL-to-NMOS Clock Drivers

The HD2916, a clock driver for the MOS memory, basically possesses a NAND function. Its Input is a TTL level and its output becomes N MOS clock input level. It operates on two power supplies – V_{CC} (5V) and V_{DD} (12V). Assuming that a maximum of five units of 4K-bit N MOS memories may be connected, it is designed to drive a load capacity of 200pF at high speeds.

FEATURES

- TTL-MOS level converter
- Switching time: 50 ns (max.)
- Average power consumption: 600mW (max.)
- Load capacity drivable: 300pF
- Mounted with 4 circuits
- Applicable temperature: 10 to 65°C

ABSOLUTE MAXIMUM RATINGS

Item	Symbol	HD2916	Unit
Supply Voltage	V_{CC}^*	-0.5 to +7	V
	V_{DD}^*	-0.5 to +15	V
Input Terminal Voltage	V_{IN}^*	-0.5 to +5.5	V
Output Load Capacitance	C_L^{**}	300	pF
Power Dissipation	P_T^{***}	700	mW
Operating Temperature	T_{opr}	0 to +70	°C
Storage Temperature	T_{stg}	-50 to +150	°C

* With respect to GND

** Per circuit

*** Per package

RECOMMENDED OPERATING CONDITION

Item	Symbol	min	typ	max	Unit
Supply Voltage	V_{CC}	4.75	5.0	5.25	V
	V_{DD}	11.4	12.0	12.6	V
Operating Temperature	T_{opr}	10	25	55	°C
Input Voltage Level	V_{IH}	2.0	—	5.5	V
	V_{IL}	-0.5	—	0.8	V

ELECTRICAL CHARACTERISTICS ($T_a=10$ to 55°C, $V_{CC}=5V \pm 5\%$, $V_{DD}=12V \pm 5\%$)

Item	Symbol	Test Condition	min	typ*	max	Unit
Input Current	A	I_{IH} $V_{IN}=2.4V$	—	—	40	μA
		I_{IL} $V_{IN}=0.4V$	—	-1	-2	mA
	B	I_{IH} $V_{IN}=2.4V$	—	—	80	μA
		I_{IL} $V_{IN}=0.4V$	—	-2	-4	mA
Output Voltage	V_{OH} $V_{IN}=0.8V, I_{OH}=-50\mu A$	$V_{DD}-0.7$	$V_{DD}-0.4$	—	V	
	V_{OL} $V_{IN}=2.0V, I_{OL}=50\mu A$	—	0.3	0.45	V	
Supply Current	I_{DDH} $V_{IN}=0V$	—	13	20	mA	
	I_{CCH} $V_{IN}=0V$	—	13	40	mA	
	I_{DDL} $V_{IN}=5V$	—	—	39	mA	
	I_{CCL} $V_{IN}=5V$	—	40	60	mA	
Average Power Dissipation	P_{TA}	$C_L=300pF, f=1MHz$ $t_w=0.5\mu s, \text{one circuit operation}$	—	300	600	mW

* $V_{CC}=5V, V_{DD}=12V$

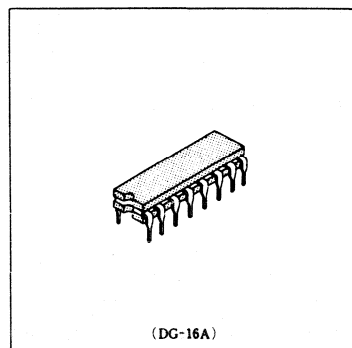

PIN ARRANGEMENT

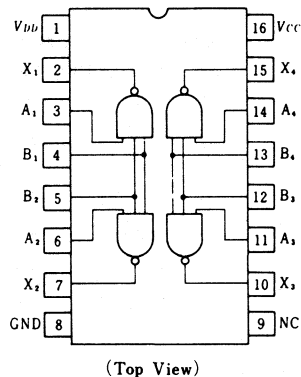

■ SWITCHING CHARACTERISTICS ($T_a=10$ to 55°C , $V_{CC}=5\text{V} \pm 5\%$, $V_{DD}=12\text{V} \pm 5\%$)

Item	Symbol	Test Condition	min	typ	max	Unit
Output Delay Time	t_{DLH}	$C_L=200\text{pF}$ $f=1\text{MHz}$ $t_w=0.5\mu\text{s}$	—	—	50	ns
	t_{DHL}		—	—	50	ns

● TEST CIRCUIT & WAVEFORMS

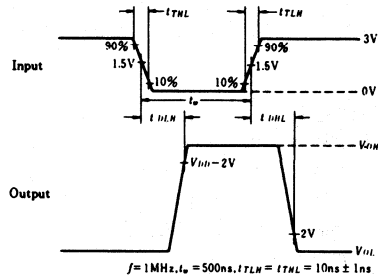
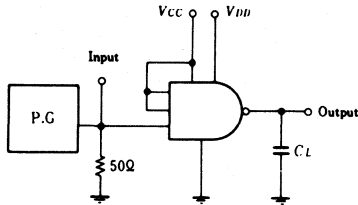

PROPAGATION DELAY TIME vs. LOAD CAPACITANCE

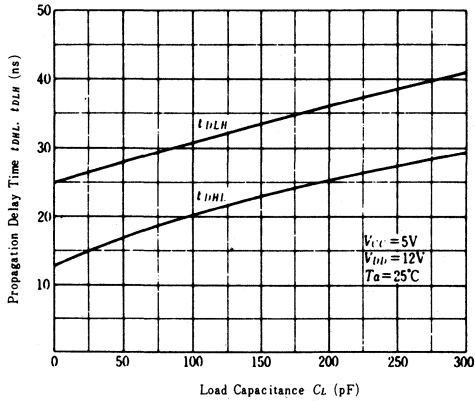

PROPAGATION DELAY TIME vs. AMBIENT TEMPERATURE

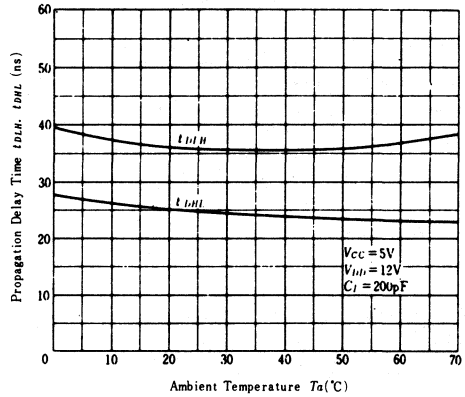

PROPAGATION DELAY TIME vs. SUPPLY VOLTAGE

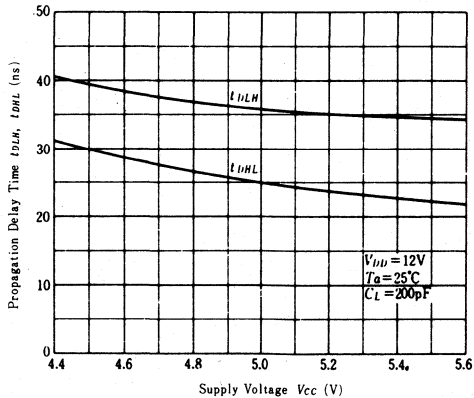

PROPAGATION DELAY TIME vs. SUPPLY VOLTAGE

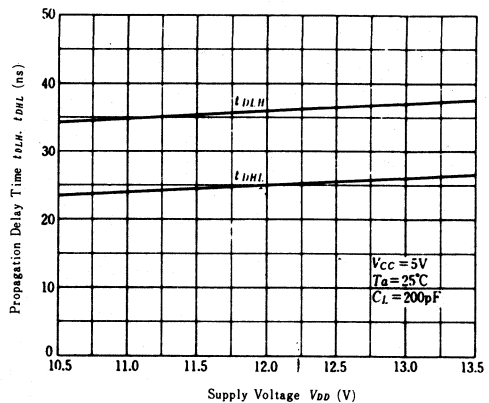

**POWER DISSIPATION
vs. CYCLE TIME**

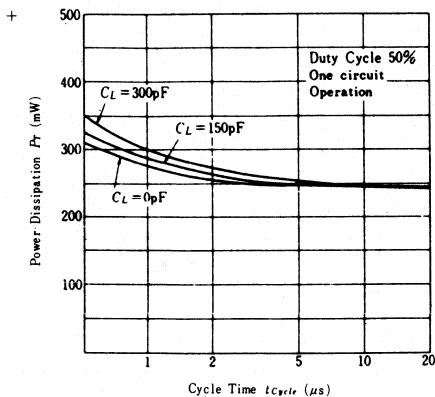

**■ ITEMS REQUIRING CARE WHEN USING
THE HD2916**

When measuring or mounting the HD2916, consider the following:

1. At the time of "H" level output, if a short circuit occurs between the output terminal and the other terminal (the GND terminal or input terminal), the element will breakdown.
2. When measuring the input/output characteristic of the circuit, do not place the input level in the vicinity of the threshold voltage (about 1.5V) for more than 10 seconds. If this caution is neglected, the element may breakdown.

HD2923

Quadruple ECL to TTL Drivers

The HD2923 is a monolithic, high speed Quadruple ECL to TTL Driver which accepts ECL input signals. It provides high output current suitable for driving the TTL clock inputs or other address multiplexing inputs of N-channel MOS memories such as the HM4816A of MK4116. Power supply requirements are ground, +5.0 Volts and -5.2 Volts. The HD2923 requires no particular power supply sequencing in order to assure standby mode of memories, because the outputs are always "high" at applying the power. Propagation delay is 10ns MAX.

The HD2923 is fabricated by means of HITACHI's Schottky Bipolar technology to assure high performance over the 0°C to 75°C ambient temperature range.

FEATURES

- High Speed $t_{pd} = 10\text{ns MAX.}$ (50% to 2.2V dc out or to +1.0V dc out, 200pF Load)
- Low Power 250mW typ. (DC)
- 10K ECL Compatible Inputs
- Pin Compatibility MC10125 or HD10125

ABSOLUTE MAXIMUM RATINGS

Item	Symbol	Value	Unit
Supply Voltage	V_{CC}	-0.5 to +7	V
	V_{EE}	-7 to +0.5	V
Input Voltage	V_{in}	V_{EE} to +0.5	V
Output Voltage	V_{out}	-1.0 to $V_{CC}+1$	V
Power Dissipation	P_T	1.0	W
Operating Temperature*	T_{opr}	-10 to +85	°C
Storage Temperature	T_{stg}	-65 to +150	°C

* under bias

RECOMMENDED OPERATING CONDITIONS

Item	Symbol	min	typ	max	Unit
Supply Voltage	V_{CC}	4.75	5.0	5.25	V
	V_{EE}	-5.46	-5.2	-4.94	V
Input Voltage	V_{IH}	-1.025	—	—	V
	V_{IL}	—	—	-1.520	V
Operating Temperature	T_{opr}	0	—	75	°C

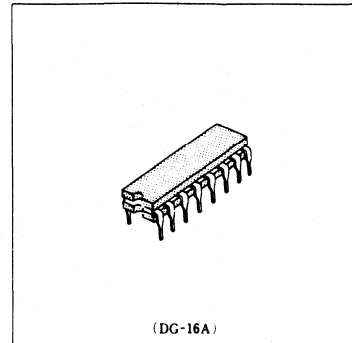

(DG-16A)

PIN ARRANGEMENT

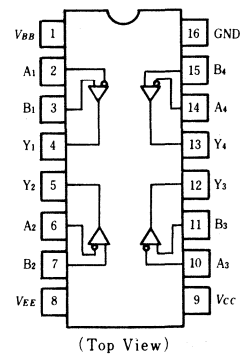

(Top View)

The V_{BB} reference voltage is available on pin 1 for use in single ended input biasing

TRUTH TABLE

Input		Output
A	B	Y
H	V_{BB}	L
L	V_{BB}	H
H	L	L
L	H	H
V_{BB}	H	H
V_{BB}	L	L
Open	Open	H

■ DC CHARACTERISTICS

Item	Symbol	Test Condition	min	typ	max	Unit
Power Supply Drain Current	$-I_{EE}$	$V_{EE} = -5.2V, V_{CC} = 5.0V$	—	22	27	mA
	I_{CCH}		—	23.5	29	mA
	I_{CCL}		—	34.5	42	mA
Input Current	I_{IH}	$V_{IH} = -0.81V$	—	—	115	μA
Input Leakage Current	I_{CBO}	$V_{IH} = -5.2V$	—	—	1.0	μA
Output Voltage	V_{OH}	$I_{OH} = -1.0mA$	2.7	—	—	V
	V_{OL}	$I_{OL} = 5.0mA$	—	—	0.5	V
Threshold Voltage	V_{OHA}	$V_{IH} = -1.1V, I_{OH} = -1.0mA$	2.7	—	—	V
	V_{OLA}	$V_{IL} = -1.48V, I_{OL} = 5.0mA$	—	—	0.5	V
Indeterminate Input Protection Tests	V_{OHS}	All inputs = V_{EE}	2.7	—	—	V
		All inputs = Open	2.7	—	—	
Reference Voltage	V_{BB}		-1.420	—	-1.150	V
Common Mode Rejection Tests	V_{OHC}	$V_{INH} = 0.300V, V_{INL} = -0.825V$	2.7	—	—	V
		$V_{INH} = -1.890V, V_{INL} = -2.890V$	2.7	—	—	
	V_{OLC}	$V_{INH} = 0.300V, V_{INL} = -0.825V$	—	—	0.5	V
		$V_{INH} = -1.890V, V_{INL} = -2.890V$	—	—	0.5	

■ AC CHARACTERISTICS

Item	Symbol	Test Condition	min	typ	max	Unit
Propagation Delay Time	t_{DR}	50% to +2.2V, $C_L = 200pF$	—	—	10	ns
	t_{DF}	50% to +1.0V, $C_L = 200pF$	—	—	10	ns
Rise Time	t^+	+1.0V to +2.2V, $C_L = 200pF$	—	—	5	ns
Fall Time	t^-	+2.2V to +1.0V, $C_L = 200pF$	—	—	5	ns

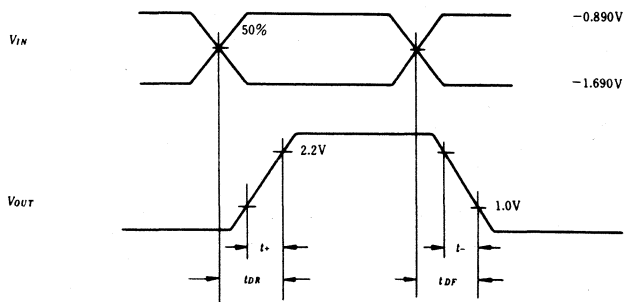

MEMO

A series of horizontal dashed lines for writing.

MEMO

A series of horizontal dashed lines for writing.



HITACHI – SALES LOCATIONS

**HITACHI ELECTRONIC
COMPONENTS EUROPE GMBH
MÜNCHEN, HEADQUARTER**

Hans-Pinsel-Straße 3
8013 Haar/b. München
☎ (089) 46 14-0
Telex: 5-22593
Telefax: (089) 46 31 51

**HITACHI ELECTRONIC
COMPONENTS EUROPE GMBH
DÜSSELDORF**

Königsallee 6
4000 Düsseldorf 1
☎ (02 11) 8 49 95
Telex: 8-584 536
Telefax: (02 11) 32 46 12

**HITACHI ELECTRONIC
COMPONENTS EUROPE GMBH
STUTT GART**

Fabrikstraße 17
7024 Filderstadt 4
☎ (07 11) 77 20 11
Telex: 7-255 267
Telefax: (07 11) 7 77 51 16

**HITACHI ELECTRONIC
COMPONENTS EUROPE GMBH
PARIS**

Bureau de Représentation en France
95-101, Rue Charles-Michels
F-93200 Saint Denis
☎ 01-8 21 60 15
Télex: 611 387
Téléfax: 01-2 43 69 97

**HITACHI ELECTRONIC
COMPONENTS EUROPE GMBH
MILANO**

Via B. Davanzati, 27
I-20158 Milano
☎ 02-3 76 30 24
Telex: 323 377
Telefax: 02-68 37 30

